



# Practical Machine Learning with Python

A Problem-Solver's Guide to Building Real-World Intelligent Systems

—

Dipanjan Sarkar

Raghav Bali

Tushar Sharma

Apress®

# Practical Machine Learning with Python

A Problem-Solver's Guide to Building Real-World Intelligent Systems



Dipanjan Sarkar

Raghav Bali

Tushar Sharma

Apress®

## *Practical Machine Learning with Python*

Dipanjan Sarkar  
Bangalore, Karnataka, India

Raghav Bali  
Bangalore, Karnataka, India

Tushar Sharma  
Bangalore, Karnataka, India

ISBN-13 (pbk): 978-1-4842-3206-4  
<https://doi.org/10.1007/978-1-4842-3207-1>

ISBN-13 (electronic): 978-1-4842-3207-1

Library of Congress Control Number: 2017963290

Copyright © 2018 by Dipanjan Sarkar, Raghav Bali and Tushar Sharma

This work is subject to copyright. All rights are reserved by the Publisher, whether the whole or part of the material is concerned, specifically the rights of translation, reprinting, reuse of illustrations, recitation, broadcasting, reproduction on microfilms or in any other physical way, and transmission or information storage and retrieval, electronic adaptation, computer software, or by similar or dissimilar methodology now known or hereafter developed.

Trademarked names, logos, and images may appear in this book. Rather than use a trademark symbol with every occurrence of a trademarked name, logo, or image we use the names, logos, and images only in an editorial fashion and to the benefit of the trademark owner, with no intention of infringement of the trademark.

The use in this publication of trade names, trademarks, service marks, and similar terms, even if they are not identified as such, is not to be taken as an expression of opinion as to whether or not they are subject to proprietary rights.

While the advice and information in this book are believed to be true and accurate at the date of publication, neither the authors nor the editors nor the publisher can accept any legal responsibility for any errors or omissions that may be made. The publisher makes no warranty, express or implied, with respect to the material contained herein.

Cover image by Freepik ([www.freepik.com](http://www.freepik.com))

Managing Director: Welmoed Spahr  
Editorial Director: Todd Green  
Acquisitions Editor: Celestin Suresh John  
Development Editor: Matthew Moodie  
Technical Reviewer: Jojo Moolayil  
Coordinating Editor: Sanchita Mandal  
Copy Editor: Kezia Endsley

Distributed to the book trade worldwide by Springer Science+Business Media New York, 233 Spring Street, 6th Floor, New York, NY 10013. Phone 1-800-SPRINGER, fax (201) 348-4505, e-mail [orders-ny@springer-sbm.com](mailto:orders-ny@springer-sbm.com), or visit [www.springeronline.com](http://www.springeronline.com). Apress Media, LLC is a California LLC and the sole member (owner) is Springer Science + Business Media Finance Inc (SSBM Finance Inc). SSBM Finance Inc is a **Delaware** corporation.

For information on translations, please e-mail [rights@apress.com](mailto:rights@apress.com), or visit <http://www.apress.com/rights-permissions>.

Apress titles may be purchased in bulk for academic, corporate, or promotional use. eBook versions and licenses are also available for most titles. For more information, reference our Print and eBook Bulk Sales web page at <http://www.apress.com/bulk-sales>.

Any source code or other supplementary material referenced by the author in this book is available to readers on GitHub via the book's product page, located at [www.apress.com/978-1-4842-3206-4](http://www.apress.com/978-1-4842-3206-4). For more detailed information, please visit <http://www.apress.com/source-code>.

Printed on acid-free paper

*This book is dedicated to my parents, partner, friends, family, and well-wishers.*

*—Dipanjan Sarkar*

*To all my inspirations, who would never read this!*

*—Raghav Bali*

*Dedicated to my family and friends.*

*—Tushar Sharma*

# Contents

<b>About the Authors</b> .....	<b>xvii</b>
<b>About the Technical Reviewer</b> .....	<b>xix</b>
<b>Acknowledgments</b> .....	<b>xxi</b>
<b>Foreword</b> .....	<b>xxiii</b>
<b>Introduction</b> .....	<b>xxv</b>
<b>■ Part I: Understanding Machine Learning</b> .....	<b>1</b>
<b>■ Chapter 1: Machine Learning Basics</b> .....	<b>3</b>
The Need for Machine Learning .....	4
Making Data-Driven Decisions .....	4
Efficiency and Scale .....	5
Traditional Programming Paradigm .....	5
Why Machine Learning? .....	6
Understanding Machine Learning .....	8
Why Make Machines Learn?.....	8
Formal Definition .....	9
A Multi-Disciplinary Field .....	13
Computer Science .....	14
Theoretical Computer Science.....	15
Practical Computer Science .....	15
Important Concepts .....	15
Data Science .....	16

<b>Mathematics</b> .....	18
Important Concepts .....	19
<b>Statistics</b> .....	24
<b>Data Mining</b> .....	25
<b>Artificial Intelligence</b> .....	25
<b>Natural Language Processing</b> .....	26
<b>Deep Learning</b> .....	28
Important Concepts .....	31
<b>Machine Learning Methods</b> .....	34
<b>Supervised Learning</b> .....	35
Classification .....	36
Regression.....	37
<b>Unsupervised Learning</b> .....	38
Clustering .....	39
Dimensionality Reduction .....	40
Anomaly Detection.....	41
Association Rule-Mining.....	41
<b>Semi-Supervised Learning</b> .....	42
<b>Reinforcement Learning</b> .....	42
<b>Batch Learning</b> .....	43
<b>Online Learning</b> .....	44
<b>Instance Based Learning</b> .....	44
<b>Model Based Learning</b> .....	45
<b>The CRISP-DM Process Model</b> .....	45
Business Understanding.....	46
Data Understanding .....	48
Data Preparation.....	50
Modeling.....	51
Evaluation .....	52
Deployment.....	52

Building Machine Intelligence .....	52
Machine Learning Pipelines .....	52
Supervised Machine Learning Pipeline .....	54
Unsupervised Machine Learning Pipeline .....	55
Real-World Case Study: Predicting Student Grant Recommendations .....	55
Objective.....	56
Data Retrieval .....	56
Data Preparation.....	57
Modeling.....	60
Model Evaluation .....	61
Model Deployment.....	61
Prediction in Action.....	62
Challenges in Machine Learning .....	64
Real-World Applications of Machine Learning .....	64
Summary.....	65
<b>■ Chapter 2: The Python Machine Learning Ecosystem .....</b>	<b>67</b>
Python: An Introduction .....	67
Strengths .....	68
Pitfalls.....	68
Setting Up a Python Environment.....	69
Why Python for Data Science? .....	71
Introducing the Python Machine Learning Ecosystem .....	72
Jupyter Notebooks.....	72
NumPy .....	75
Pandas.....	84
Scikit-learn .....	96
Neural Networks and Deep Learning.....	102
Text Analytics and Natural Language Processing.....	112
Statsmodels.....	116
Summary.....	118

- **Part II: The Machine Learning Pipeline..... 119**
- **Chapter 3: Processing, Wrangling, and Visualizing Data..... 121**
- Data Collection ..... 122
  - CSV ..... 122
  - JSON..... 124
  - XML..... 128
  - HTML and Scraping ..... 131
  - SQL ..... 136
- Data Description..... 137
  - Numeric ..... 137
  - Text ..... 137
  - Categorical ..... 137
- Data Wrangling ..... 138
  - Understanding Data..... 138
  - Filtering Data ..... 141
  - Typecasting..... 144
  - Transformations..... 144
  - Imputing Missing Values..... 145
  - Handling Duplicates..... 147
  - Handling Categorical Data ..... 147
  - Normalizing Values ..... 148
  - String Manipulations ..... 149
- Data Summarization..... 149
- Data Visualization ..... 151
  - Visualizing with Pandas..... 152
  - Visualizing with Matplotlib..... 161
  - Python Visualization Ecosystem ..... 176
- Summary..... 176



■ **Chapter 4: Feature Engineering and Selection** ..... 177

**Features: Understand Your Data Better** ..... 178

        Data and Datasets ..... 178

        Features..... 179

        Models ..... 179

**Revisiting the Machine Learning Pipeline** ..... 179

**Feature Extraction and Engineering** ..... 181

        What Is Feature Engineering?..... 181

        Why Feature Engineering?..... 183

        How Do You Engineer Features? ..... 184

**Feature Engineering on Numeric Data** ..... 185

        Raw Measures ..... 185

        Binarization..... 187

        Rounding ..... 188

        Interactions..... 189

        Binning ..... 191

        Statistical Transformations ..... 197

**Feature Engineering on Categorical Data**..... 200

        Transforming Nominal Features ..... 201

        Transforming Ordinal Features ..... 202

        Encoding Categorical Features..... 203

**Feature Engineering on Text Data** ..... 209

        Text Pre-Processing..... 210

        Bag of Words Model..... 211

        Bag of N-Grams Model ..... 212

        TF-IDF Model ..... 213

        Document Similarity ..... 214

        Topic Models..... 216

        Word Embeddings..... 217

Feature Engineering on Temporal Data .....	220
Date-Based Features .....	221
Time-Based Features .....	222
Feature Engineering on Image Data .....	224
Image Metadata Features .....	225
Raw Image and Channel Pixels .....	225
Grayscale Image Pixels .....	227
Binning Image Intensity Distribution .....	227
Image Aggregation Statistics .....	228
Edge Detection .....	229
Object Detection .....	230
Localized Feature Extraction .....	231
Visual Bag of Words Model .....	233
Automated Feature Engineering with Deep Learning .....	236
Feature Scaling .....	239
Standardized Scaling .....	240
Min-Max Scaling .....	240
Robust Scaling .....	241
Feature Selection .....	242
Threshold-Based Methods .....	243
Statistical Methods .....	244
Recursive Feature Elimination .....	247
Model-Based Selection .....	248
Dimensionality Reduction .....	249
Feature Extraction with Principal Component Analysis .....	250
Summary .....	252
<b>■ Chapter 5: Building, Tuning, and Deploying Models .....</b>	<b>255</b>
Building Models .....	256
Model Types .....	257
Learning a Model .....	260
Model Building Examples .....	263

<b>Model Evaluation</b> .....	<b>271</b>
Evaluating Classification Models .....	271
Evaluating Clustering Models .....	278
Evaluating Regression Models.....	281
<b>Model Tuning</b> .....	<b>282</b>
Introduction to Hyperparameters.....	283
The Bias-Variance Tradeoff.....	284
Cross Validation .....	288
Hyperparameter Tuning Strategies .....	291
<b>Model Interpretation</b> .....	<b>295</b>
Understanding Skater .....	297
Model Interpretation in Action .....	298
<b>Model Deployment</b> .....	<b>302</b>
Model Persistence .....	302
Custom Development .....	303
In-House Model Deployment .....	303
Model Deployment as a Service .....	304
<b>Summary</b> .....	<b>304</b>
<b>■ Part III: Real-World Case Studies</b> .....	<b>305</b>
<b>■ Chapter 6: Analyzing Bike Sharing Trends</b> .....	<b>307</b>
The Bike Sharing Dataset.....	307
Problem Statement .....	308
Exploratory Data Analysis.....	308
Preprocessing.....	308
Distribution and Trends.....	310
Outliers .....	312
Correlations .....	314

<b>Regression Analysis .....</b>	<b>315</b>
Types of Regression.....	315
Assumptions .....	316
Evaluation Criteria .....	316
<b>Modeling.....</b>	<b>317</b>
Linear Regression.....	319
Decision Tree Based Regression.....	323
<b>Next Steps .....</b>	<b>330</b>
<b>Summary.....</b>	<b>330</b>
<b>■ Chapter 7: Analyzing Movie Reviews Sentiment .....</b>	<b>331</b>
Problem Statement .....	332
Setting Up Dependencies .....	332
Getting the Data .....	333
Text Pre-Processing and Normalization .....	333
Unsupervised Lexicon-Based Models .....	336
Bing Liu's Lexicon.....	337
MPQA Subjectivity Lexicon .....	337
Pattern Lexicon.....	338
AFINN Lexicon.....	338
SentiWordNet Lexicon .....	340
VADER Lexicon.....	342
Classifying Sentiment with Supervised Learning.....	345
Traditional Supervised Machine Learning Models.....	346
Newer Supervised Deep Learning Models .....	349
Advanced Supervised Deep Learning Models .....	355
Analyzing Sentiment Causation.....	363
Interpreting Predictive Models .....	363
Analyzing Topic Models .....	368
<b>Summary.....</b>	<b>372</b>

■ <b>Chapter 8: Customer Segmentation and Effective Cross Selling .....</b>	<b>373</b>
Online Retail Transactions Dataset.....	374
Exploratory Data Analysis.....	374
Customer Segmentation.....	378
Objectives.....	378
Strategies .....	379
Clustering Strategy .....	380
Cross Selling .....	392
Market Basket Analysis with Association Rule-Mining.....	393
Association Rule-Mining Basics .....	394
Association Rule-Mining in Action.....	396
Summary.....	405
■ <b>Chapter 9: Analyzing Wine Types and Quality .....</b>	<b>407</b>
Problem Statement .....	407
Setting Up Dependencies.....	408
Getting the Data .....	408
Exploratory Data Analysis.....	409
Process and Merge Datasets.....	409
Understanding Dataset Features .....	410
Descriptive Statistics.....	413
Inferential Statistics.....	414
Univariate Analysis .....	416
Multivariate Analysis .....	419
Predictive Modeling.....	426
Predicting Wine Types .....	427
Predicting Wine Quality .....	433
Summary.....	446

■ **Chapter 10: Analyzing Music Trends and Recommendations..... 447**

    The Million Song Dataset Taste Profile ..... 448

    Exploratory Data Analysis..... 448

        Loading and Trimming Data..... 448

        Enhancing the Data ..... 451

        Visual Analysis..... 452

    Recommendation Engines..... 456

        Types of Recommendation Engines..... 457

        Utility of Recommendation Engines..... 457

        Popularity-Based Recommendation Engine ..... 458

        Item Similarity Based Recommendation Engine..... 459

        Matrix Factorization Based Recommendation Engine ..... 461

    A Note on Recommendation Engine Libraries..... 466

    Summary..... 466

■ **Chapter 11: Forecasting Stock and Commodity Prices ..... 467**

    Time Series Data and Analysis ..... 467

        Time Series Components..... 469

        Smoothing Techniques ..... 471

    Forecasting Gold Price ..... 474

        Problem Statement..... 474

        Dataset ..... 474

        Traditional Approaches ..... 474

        Modeling..... 476

    Stock Price Prediction ..... 483

        Problem Statement..... 484

        Dataset ..... 484

        Recurrent Neural Networks: LSTM ..... 485

        Upcoming Techniques: Prophet ..... 495

    Summary..... 497

■ **Chapter 12: Deep Learning for Computer Vision ..... 499**

    Convolutional Neural Networks ..... 499

    Image Classification with CNNs ..... 501

        Problem Statement..... 501

        Dataset ..... 501

        CNN Based Deep Learning Classifier from Scratch ..... 502

        CNN Based Deep Learning Classifier with Pretrained Models..... 505

    Artistic Style Transfer with CNNs ..... 509

        Background ..... 510

        Preprocessing..... 511

        Loss Functions..... 513

        Custom Optimizer ..... 515

        Style Transfer in Action..... 516

    Summary..... 520

**Index..... 521**

# About the Authors



**Dipanjan Sarkar** is a data scientist at Intel, on a mission to make the world more connected and productive. He primarily works on Data Science, analytics, business intelligence, application development, and building large-scale intelligent systems. He holds a master of technology degree in Information Technology with specializations in Data Science and Software Engineering from the International Institute of Information Technology, Bangalore. He is also an avid supporter of self-learning, especially Massive Open Online Courses and also holds a Data Science Specialization from Johns Hopkins University on Coursera.

Dipanjan has been an analytics practitioner for several years, specializing in statistical, predictive, and text analytics. Having a passion for Data Science and education, he is a Data Science Mentor at Springboard, helping people up-skill on areas like Data Science and Machine Learning. Dipanjan has also authored several books on R, Python, Machine Learning, and analytics, including *Text Analytics with Python*, Apress 2016. Besides this, he occasionally reviews technical books

and acts as a course beta tester for Coursera. Dipanjan's interests include learning about new technology, financial markets, disruptive start-ups, Data Science, and more recently, artificial intelligence and Deep Learning.



**Raghav Bali** is a data scientist at Intel, enabling proactive and data-driven IT initiatives. He primarily works on Data Science, analytics, business intelligence, and development of scalable Machine Learning-based solutions. He has also worked in domains such as ERP and finance with some of the leading organizations in the world. Raghav has a master's degree (gold medalist) in Information Technology from International Institute of Information Technology, Bangalore.

Raghav is a technology enthusiast who loves reading and playing around with new gadgets and technologies. He has also authored several books on R, Machine Learning, and Analytics. He is a shutterbug, capturing moments when he isn't busy solving problems.





**Tushar Sharma** has a master's degree from International Institute of Information Technology, Bangalore. He works as a Data Scientist with Intel. His work involves developing analytical solutions at scale using enormous volumes of infrastructure data. In his previous role, he worked in the financial domain developing scalable Machine Learning solutions for major financial organizations. He is proficient in Python, R, and Big Data frameworks like Spark and Hadoop.

Apart from work, Tushar enjoys watching movies, playing badminton, and is an avid reader. He has also authored a book on R and social media analytics.

# About the Technical Reviewer



**Jojo Moolayil** is an Artificial Intelligence professional and published author of the book: *Smarter Decisions – The Intersection of IoT and Decision Science*. With over five years of industrial experience in A.I., Machine Learning, Decision Science, and IoT, he has worked with industry leaders on high impact and critical projects across multiple verticals. He is currently working with General Electric, the pioneer and leader in Data Science for Industrial IoT, and lives in Bengaluru—the Silicon Valley of India.

He was born and raised in Pune, India and graduated from University of Pune with a major in Information Technology Engineering. He started his career with Mu Sigma Inc., the world’s largest pure play analytics provider and then Flutura, an IoT Analytics startup. He has also worked with the leaders of many Fortune 50 clients.

In his present role with General Electric, he focuses on solving A.I. and decision science problems for Industrial IoT use cases and developing Data Science products and platforms for Industrial IoT.

Apart from authoring books on decision science and IoT, Jojo has also been technical reviewer for various books on Machine Learning and Business Analytics with Apress. He is an active Data Science tutor and maintains a blog at <http://www.jojomoolayil.com/web/blog/>.

You can reach out to Jojo at:

<http://www.jojomoolayil.com/>

<https://www.linkedin.com/in/jojo62000>

*I would like to thank my family, friends, and mentors for their kind support and constant motivation throughout my life.*

—Jojo John Moolayil

# Acknowledgments

This book would have definitely not been a reality without the help and support from some excellent people and organizations that have helped us along this journey. First and foremost, a big thank you to all our readers for not only reading our books but also supporting us with valuable feedback and insights. Truly, we have learnt a lot from all of you and still continue to do so. We would like to acknowledge the entire team at Apress for working tirelessly behind the scenes to create and publish quality content for everyone. A big shout-out goes to the entire Python developer community, especially to the developers of frameworks like numpy, scipy, scikit-learn, spacy, nltk, pandas, statsmodels, keras, and tensorflow. Thanks also to organizations like Anaconda, for making the lives of data scientists easier and for fostering an amazing ecosystem around Data Science and Machine Learning that has been growing exponentially with time. We also thank our friends, colleagues, teachers, managers, and well-wishers for supporting us with excellent challenges, strong motivation, and good thoughts. A special mention goes to Ram Varra for not only being a great mentor and guide to us, but also teaching us how to leverage Data Science as an effective tool from technical aspects as well as from the business and domain perspectives for adding real impact and value. We would also like to express our gratitude to our managers and mentors, both past and present, including Nagendra Venkatesh, Sanjeev Reddy, Tamoghna Ghosh and Sailaja Parthasarathy.

A lot of the content in this book wouldn't have been possible without the help from several people and some excellent resources. We would like to thank Christopher Olah for providing some excellent depictions and explanation for LSTM models (<http://colah.github.io>), Edwin Chen for also providing an excellent depiction for LSTM models in his blog (<http://blog.echen.me>), Gabriel Moreira for providing some excellent pointers on feature engineering techniques, Ian London for his resources on the Visual Bag of Words Model (<https://ianlondon.github.io>), the folks at DataScience.com, especially Prमित Choudhary, Ian Swanson, and Aaron Kramer, for helping us cover a lot of ground in model interpretation with skater (<https://www.datascience.com>), Karlijn Willems and DataCamp for providing an excellent source of information pertaining to wine quality analysis (<https://www.datacamp.com>), Siraj Raval for creating amazing content especially with regard to time series analysis and recommendation engines, Amar Lalwani for giving us some vital inputs around time series forecasting with Deep Learning, Harish Narayanan for an excellent article on neural style transfer (<https://harishnarayanan.org/writing>), and last but certainly not the least, François Chollet for creating keras and writing an excellent book on Deep Learning.

I would also like to acknowledge and express my gratitude to my parents, Digbijoy and Sampa, my partner Durba and my family and well-wishers for their constant love, support, and encouragement that drive me to strive to achieve more. Special thanks to my fellow colleagues, friends, and co-authors Raghav and Tushar for slogging many days and nights with me and making this experience worthwhile! Finally, once again I would like to thank the entire team at Apress, especially Sanchita Mandal, Celestin John, Matthew Moodie, and our technical reviewer, Jojo Moolayil, for being a part of this wonderful journey.

—Dipanjan Sarkar

## ■ ACKNOWLEDGMENTS

I am indebted to my family, teachers, friends, colleagues, and mentors who have inspired and encouraged me over the years. I would also like to take this opportunity to thank my co-authors and good friends Dipanjan Sarkar and Tushar Sharma; you guys are amazing. Special thanks to Sanchita Mandal, Celestin John, Matthew Moodie, and Apress for the opportunity and support, and last but not the least, thank you to Jojo Moolayil for the feedback and reviews

—Raghav Bali

I would like to express my gratitude to my family, teachers, and friends who have encouraged, supported, and taught me over the years. Special thanks to my classmates, friends, and colleagues, Dipanjan Sarkar and Raghav Bali, for co-authoring and making this journey wonderful through their valuable inputs and eye for detail.

I would also like to thank Matthew Moodie, Sanchita Mandal, Celestin John, and Apress for the opportunity and their support throughout the journey. Special thanks to the reviews and comments provided by Jojo Moolayil.

—Tushar Sharma

# Foreword

The availability of affordable compute power enabled by Moore's law has been enabling rapid advances in Machine Learning solutions and driving adoption across diverse segments of the industry. The ability to learn complex models underlying the real-world processes from observed (training) data through systemic, easy-to-apply Machine Learning solution stacks has been of tremendous attraction to businesses to harness meaningful business value. The appeal and opportunities of Machine Learning have resulted in the availability of many resources—books, tutorials, online training, and courses for solution developers, analysts, engineers, and scientists to learn the algorithms and implement platforms and methodologies. It is not uncommon for someone just starting out to get overwhelmed by the abundance of the material. In addition, not following a structured workflow might not yield consistent and relevant results with Machine Learning solutions.

Key requirements for building robust Machine Learning applications and getting consistent, actionable results involve investing significant time and effort in understanding the objectives and key value of the project, establishing robust data pipelines, analyzing and visualizing data, and feature engineering, selection, and modeling. The iterative nature of these projects involves several Select → Apply → Validate → Tune cycles before coming up with a suitable Machine Learning-based model. A final and important step is to integrate the solution (Machine Learning model) into existing (or new) organization systems or business processes to sustain actionable and relevant results. Hence, the broad requirements of the ingredients for a robust Machine Learning solution require a development platform that is suited not just for interactive modeling of Machine Learning, but also excels in data ingestion, processing, visualization, systems integration, and strong ecosystem support for runtime deployment and maintenance. Python is an excellent choice of language because it fits the need of the hour with its multi-purpose capabilities, ease of implementation and integration, active developer community, and ever-growing Machine Learning ecosystem, leading to its adoption for Machine Learning growing rapidly.

The authors of this book have leveraged their hands-on experience with solving real-world problems using Python and its Machine Learning ecosystem to help the readers gain the solid knowledge needed to apply essential concepts, methodologies, tools, and techniques for solving their own real-world problems and use-cases. *Practical Machine Learning with Python* aims to cater to readers with varying skill levels ranging from beginners to experts and enable them in structuring and building practical Machine Learning solutions.

—Ram R. Varra, Senior Principal Engineer, Intel

# Introduction

Data is the new oil and Machine Learning is a powerful concept and framework for making the best out of it. In this age of automation and intelligent systems, it is hardly a surprise that Machine Learning and Data Science are some of the top buzz words. The tremendous interest and renewed investments in the field of Data Science across industries, enterprises, and domains are clear indicators of its enormous potential. Intelligent systems and data-driven organizations are becoming a reality and the advancements in tools and techniques is only helping it expand further. With data being of paramount importance, there has never been a higher demand for Machine Learning and Data Science practitioners than there is now. Indeed, the world is facing a shortage of data scientists. It's been coined "The sexiest job in the 21<sup>st</sup> Century" which makes it all the more worthwhile to try to build some valuable expertise in this domain.

*Practical Machine Learning with Python* is a problem solver's guide to building real-world intelligent systems. It follows a comprehensive three-tiered approach packed with concepts, methodologies, hands-on examples, and code. This book helps its readers master the essential skills needed to recognize and solve complex problems with Machine Learning and Deep Learning by following a data-driven mindset. Using real-world case studies that leverage the popular Python Machine Learning ecosystem, this book is your perfect companion for learning the art and science of Machine Learning to become a successful practitioner. The concepts, techniques, tools, frameworks, and methodologies used in this book will teach you how to think, design, build, and execute Machine Learning systems and projects successfully.

This book will get you started on the ways to leverage the Python Machine Learning ecosystem with its diverse set of frameworks and libraries. The three-tiered approach of this book starts by focusing on building a strong foundation around the basics of Machine Learning and relevant tools and frameworks, the next part emphasizes the core processes around building Machine Learning pipelines, and the final part leverages this knowledge on solving some real-world case studies from diverse domains, including retail, transportation, movies, music, computer vision, art, and finance. We also cover a wide range of Machine Learning models, including regression, classification, forecasting, rule-mining, and clustering. This book also touches on cutting edge methodologies and research from the field of Deep Learning, including concepts like transfer learning and case studies relevant to computer vision, including image classification and neural style transfer. Each chapter consists of detailed concepts with complete hands-on examples, code, and detailed discussions. The main intent of this book is to give a wide range of readers—including IT professionals, analysts, developers, data scientists, engineers, and graduate students—a structured approach to gaining essential skills pertaining to Machine Learning and enough knowledge about leveraging state-of-the-art Machine Learning techniques and frameworks so that they can start solving their own real-world problems. This book is application-focused, so it's not a replacement for gaining deep conceptual and theoretical knowledge about Machine Learning algorithms, methods, and their internal implementations. We strongly recommend you supplement the practical knowledge gained through this book with some standard books on data mining, statistical analysis, and theoretical aspects of Machine Learning algorithms and methods to gain deeper insights into the world of Machine Learning.

**PART I**



# **Understanding Machine Learning**

## CHAPTER 1



# Machine Learning Basics

The idea of making intelligent, sentient, and self-aware machines is not something that suddenly came into existence in the last few years. In fact a lot of lore from Greek mythology talks about intelligent machines and inventions having self-awareness and intelligence of their own. The origins and the evolution of the computer have been really revolutionary over a period of several centuries, starting from the basic Abacus and its descendant the slide rule in the 17th Century to the first general purpose computer designed by Charles Babbage in the 1800s. In fact, once computers started evolving with the invention of the Analytical Engine by Babbage and the first computer program, which was written by Ada Lovelace in 1842, people started wondering and contemplating that could there be a time when computers or machines truly become intelligent and start thinking for themselves. In fact, the renowned computer scientist, Alan Turing, was highly influential in the development of theoretical computer science, algorithms, and formal language and addressed concepts like artificial intelligence and Machine Learning as early as the 1950s. This brief insight into the evolution of making machines learn is just to give you an idea of something that has been out there since centuries but has recently started gaining a lot of attention and focus.

With faster computers, better processing, better computation power, and more storage, we have been living in what I like to call, the “age of information” or the “age of data”. Day in and day out, we deal with managing *Big Data* and building intelligent systems by using concepts and methodologies from *Data Science*, *Artificial Intelligence*, *Data Mining*, and *Machine Learning*. Of course, most of you must have heard many of the terms I just mentioned and come across sayings like “*data is the new oil*”. The main challenge that businesses and organizations have embarked on in the last decade is to use approaches to try to make sense of all the data that they have and use valuable information and insights from it in order to make better decisions. Indeed with great advancements in technology, including availability of cheap and massive computing, hardware (including GPUs) and storage, we have seen a thriving ecosystem built around domains like Artificial Intelligence, Machine Learning, and most recently Deep Learning. Researchers, developers, data scientists, and engineers are working continuously round the clock to research and build tools, frameworks, algorithms, techniques, and methodologies to build intelligent models and systems that can predict events, automate tasks, perform complex analyses, detect anomalies, self-heal failures, and even understand and respond to human inputs.

This chapter follows a structured approach to cover various concepts, methodologies, and ideas associated with Machine Learning. The core idea is to give you enough background on why we need Machine Learning, the fundamental building blocks of Machine Learning, and what Machine Learning offers us presently. This will enable you to learn about how best you can leverage Machine Learning to get the maximum from your data. Since this is a book on practical Machine Learning, while we will be focused on specific use cases, problems, and real-world case studies in subsequent chapters, it is extremely important to understand formal definitions, concepts, and foundations with regard to learning algorithms, data management, model building, evaluation, and deployment. Hence, we cover all these aspects, including industry standards related to data mining and Machine Learning workflows, so that it gives you a foundational framework that can be applied to approach and tackle any of the real-world problems we solve



in subsequent chapters. Besides this, we also cover the different inter-disciplinary fields associated with Machine Learning, which are in fact related fields all under the umbrella of *artificial intelligence*.

This book is more focused on applied or practical Machine Learning, hence the major focus in most of the chapters will be the application of Machine Learning techniques and algorithms to solve real-world problems. Hence some level of proficiency in basic mathematics, statistics, and Machine Learning would be beneficial. However since this book takes into account the varying levels of expertise for various readers, this foundational chapter along with other chapters in Part I and II will get you up to speed on the key aspects of Machine Learning and building Machine Learning pipelines. If you are already familiar with the basic concepts relevant to Machine Learning and its significance, you can quickly skim through this chapter and head over to Chapter 2, “The Python Machine Learning Ecosystem,” where we discuss the benefits of Python for building Machine Learning systems and the major tools and frameworks typically used to solve Machine Learning problems.

---

This book heavily emphasizes learning by doing with a lot of code snippets, examples, and multiple case studies. We leverage Python 3 and depict all our examples with relevant code files (.py) and jupyter notebooks (.ipynb) for a more interactive experience. We encourage you to refer to the GitHub repository for this book at <https://github.com/dipanjanS/practical-machine-learning-with-python>, where we will be sharing necessary code and datasets pertaining to each chapter. You can leverage this repository to try all the examples by yourself as you go through the book and adopt them in solving your own real-world problems. Bonus content relevant to Machine Learning and Deep Learning will also be shared in the future, so keep watching that space!

---

## The Need for Machine Learning

Human beings are perhaps the most advanced and intelligent lifeform on this planet at the moment. We can think, reason, build, evaluate, and solve complex problems. The human brain is still something we ourselves haven't figured out completely and hence artificial intelligence is still something that's not surpassed human intelligence in several aspects. Thus you might get a pressing question in mind as to why do we really need Machine Learning? What is the need to go out of our way to spend time and effort to make machines learn and be intelligent? The answer can be summed up in a simple sentence, “To make data-driven decisions at scale”. We will dive into details to explain this sentence in the following sections.

## Making Data-Driven Decisions

Getting key information or insights from data is the key reason businesses and organizations invest heavily in a good workforce as well as newer paradigms and domains like Machine Learning and artificial intelligence. The idea of data-driven decisions is not new. Fields like operations research, statistics, and management information systems have existed for decades and attempt to bring efficiency to any business or organization by using data and analytics to make data-driven decisions. The art and science of leveraging your data to get actionable insights and make better decisions is known as making data-driven decisions. Of course, this is easier said than done because rarely can we directly use raw data to make any insightful decisions. Another important aspect of this problem is that often we use the power of reasoning or intuition to try to make decisions based on what we have learned over a period of time and on the job. Our brain is an extremely powerful device that helps us do so. Consider problems like understanding what your fellow colleagues or friends are speaking, recognizing people in images, deciding whether to approve or reject a business transaction, and so on. While we can solve these problems almost involuntarily, can you explain someone the process of how you solved each of these problems? Maybe to some extent, but after a while,

it would be like, “Hey! My brain did most of the thinking for me!” This is exactly why it is difficult to make machines learn to solve these problems like regular computational programs like computing loan interest or tax rebates. Solutions to problems that cannot be programmed inherently need a different approach where we use the data itself to drive decisions instead of using programmable logic, rules, or code to make these decisions. We discuss this further in future sections.

## Efficiency and Scale

While getting insights and making decisions driven by data are of paramount importance, it also needs to be done with efficiency and at scale. The key idea of using techniques from Machine Learning or artificial intelligence is to automate processes or tasks by learning specific patterns from the data. We all want computers or machines to tell us when a stock might rise or fall, whether an image is of a computer or a television, whether our product placement and offers are the best, determine shopping price trends, detect failures or outages before they occur, and the list just goes on! While human intelligence and expertise is something that we definitely can't do without, we need to solve real-world problems at huge scale with efficiency.

### A REAL-WORLD PROBLEM AT SCALE

Consider the following real-world problem. You are the manager of a world-class infrastructure team for the DSS Company that provides Data Science services in the form of cloud based infrastructure and analytical platforms for other businesses and consumers. Being a provider of services and infrastructure, you want your infrastructure to be top-notch and robust to failures and outages. Considering you are starting out of St. Louis in a small office, you have a good grasp over monitoring all your network devices including routers, switches, firewalls, and load balancers regularly with your team of 10 experienced employees. Soon you make a breakthrough with providing cloud based Deep Learning services and GPUs for development and earn huge profits. However, now you keep getting more and more customers. The time has come for expanding your base to offices in San Francisco, New York, and Boston. You have a huge connected infrastructure now with hundreds of network devices in each building! How will you manage your infrastructure at scale now? Do you hire more manpower for each office or do you try to leverage Machine Learning to deal with tasks like outage prediction, auto-recovery, and device monitoring? Think about this for some time from both an engineer as well as a manager's point of view.

## Traditional Programming Paradigm

Computers, while being extremely sophisticated and complex devices, are just another version of our well known idiot box, the television! “How can that be?” is a very valid question at this point. Let's consider a television or even one of the so-called smart TVs, which are available these days. In theory as well as in practice, the TV will do whatever you program it to do. It will show you the channels you want to see, record the shows you want to view later on, and play the applications you want to play! The computer has been doing the exact same thing but in a different way. Traditional programming paradigms basically involve the user or programmer to write a set of instructions or operations using code that makes the computer perform specific computations on data to give the desired results. Figure 1-1 depicts a typical workflow for traditional programming paradigms.

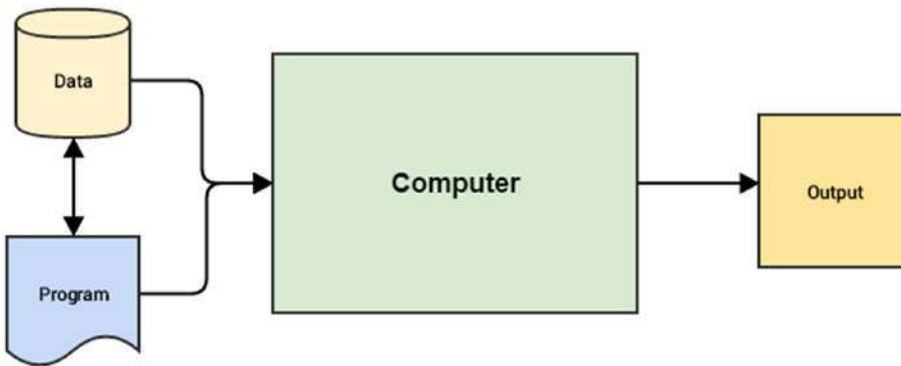

**Figure 1-1.** *Traditional programming paradigm*

From Figure 1-1, you can get the idea that the core inputs that are given to the computer are data and one or more programs that are basically code written with the help of a programming language, such as high-level languages like Java, Python, or low-level like C or even Assembly. Programs enable computers to work on data, perform computations, and generate output. A task that can be performed really well with traditional programming paradigms is computing your annual tax.

Now, let's think about the real-world infrastructure problem we discussed in the previous section for DSS Company. Do you think a traditional programming approach might be able to solve this problem? Well, it could to some extent. We might be able to tap in to the device data and event streams and logs and access various device attributes like usage levels, signal strength, incoming and outgoing connections, memory and processor usage levels, error logs and events, and so on. We could then use the domain knowledge of our network and infrastructure experts in our teams and set up some event monitoring systems based on specific decisions and rules based on these data attributes. This would give us what we could call as a rule-based reactive analytical solution where we can monitor devices, observe if any specific anomalies or outages occur, and then take necessary action to quickly resolve any potential issues. We might also have to hire some support and operations staff to continuously monitor and resolve issues as needed. However, there is still a pressing problem of trying to prevent as many outages or issues as possible before they actually take place. Can Machine Learning help us in some way?

## Why Machine Learning?

We will now address the question that started this discussion of why we need Machine Learning. Considering what you have learned so far, while the traditional programming paradigm is quite good and human intelligence and domain expertise is definitely an important factor in making data-driven decisions, we need Machine Learning to make faster and better decisions. The Machine Learning paradigm tries to take into account data and expected outputs or results if any and uses the computer to build the program, which is also known as a model. This program or model can then be used in the future to make necessary decisions and give expected outputs from new inputs. Figure 1-2 shows how the Machine Learning paradigm is similar yet different from traditional programming paradigms.

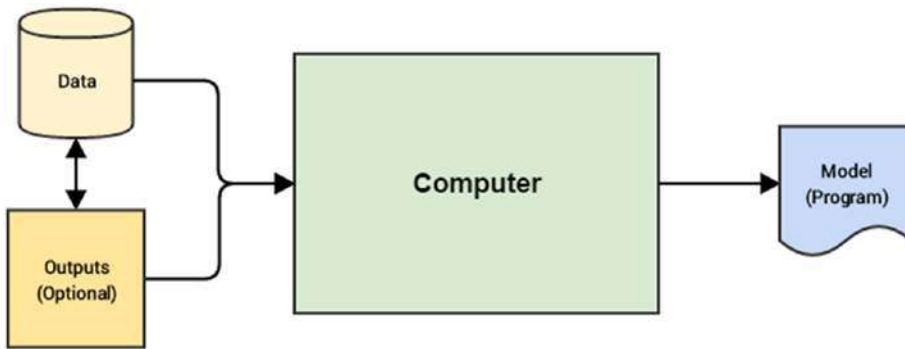

**Figure 1-2.** Machine Learning paradigm

Figure 1-2 reinforces the fact that in the Machine Learning paradigm, the machine, in this context the computer, tries to use input data and expected outputs to try to learn inherent patterns in the data that would ultimately help in building a model analogous to a computer program, which would help in making data-driven decisions in the future (predict or tell us the output) for new input data points by using the learned knowledge from previous data points (its knowledge or experience). You might start to see the benefit in this. We would not need hand-coded rules, complex flowcharts, case and if-then conditions, and other criteria that are typically used to build any decision making system or a decision support system. The basic idea is to use Machine Learning to make insightful decisions.

This will be clearer once we discuss our real-world problem of managing infrastructure for DSS Company. In the traditional programming approach, we talked about hiring new staff, setting up rule-based monitoring systems, and so on. If we were to use a Machine Learning paradigm shift here, we could go about solving the problem using the following steps.

- Leverage device data and logs and make sure we have enough historical data in some data store (database, logs, or flat files)
- Decide key data attributes that could be useful for building a model. This could be device usage, logs, memory, processor, connections, line strength, links, and so on.
- Observe and capture device attributes and their behavior over various time periods that would include normal device behavior and anomalous device behavior or outages. These outcomes would be your outputs and device data would be your inputs
- Feed these input and output pairs to any specific Machine Learning algorithm in your computer and build a model that learns inherent device patterns and observes the corresponding output or outcome
- Deploy this model such that for newer values of device attributes it can predict if a specific device is behaving normally or it might cause a potential outage

Thus once you are able to build a Machine Learning model, you can easily deploy it and build an intelligent system around it such that you can not only monitor devices reactively but you would be able to proactively identify potential problems and even fix them before any issues crop up. Imagine building self-heal or auto-heal systems coupled with round the clock device monitoring. The possibilities are indeed endless and you will not have to keep on hiring new staff every time you expand your office or buy new infrastructure.

Of course, the workflow discussed earlier with the series of steps needed for building a Machine Learning model is much more complex than how it has been portrayed, but again this is just to emphasize and make you think more conceptually rather than technically of how the paradigm has shifted in case

of Machine Learning processes and you need to change your thinking too from the traditional based approaches toward being more data-driven. The beauty of Machine Learning is that it is never domain constrained and you can use techniques to solve problems spanning multiple domains, businesses, and industries. Also, as depicted in Figure 1-2, you always do not need output data points to build a model; sometimes input data is sufficient (or rather output data might not be present) for techniques more suited toward unsupervised learning (which we will discuss in depth later on in this chapter). A simple example is trying to determine customer shopping patterns by looking at the grocery items they typically buy together in a store based on past transactional data. In the next section, we take a deeper dive toward understanding Machine Learning.

## Understanding Machine Learning

By now, you have seen how a typical real-world problem suitable to solve using Machine Learning might look like. Besides this, you have also got a good grasp over the basics of traditional programming and Machine Learning paradigms. In this section, we discuss Machine Learning in more detail. To be more specific, we will look at Machine Learning from a conceptual as well as a domain-specific standpoint. Machine Learning came into prominence perhaps in the 1990s when researchers and scientists started giving it more prominence as a sub-field of Artificial Intelligence (AI) such that techniques borrow concepts from AI, probability, and statistics, which perform far better compared to using fixed rule-based models requiring a lot of manual time and effort. Of course, as we have pointed out earlier, Machine Learning didn't just come out of nowhere in the 1990s. It is a multi-disciplinary field that has gradually evolved over time and is still evolving as we speak.

A brief mention of history of evolution would be really helpful to get an idea of the various concepts and techniques that have been involved in the development of Machine Learning and AI. You could say that it started off in the late 1700s and the early 1800s when the first works of research were published which basically talked about the Bayes' Theorem. In fact Thomas Bayes' major work, "An Essay Towards Solving a Problem in the Doctrine of Chances," was published in 1763. Besides this, a lot of research and discovery was done during this time in the field of probability and mathematics. This paved the way for more ground breaking research and inventions in the 20th Century, which included Markov Chains by Andrey Markov in the early 1900s, proposition of a learning system by Alan Turing, and the invention of the very famous perceptron by Frank Rosenblatt in the 1950s. Many of you might know that neural networks had several highs and lows since the 1950s and they finally came back to prominence in the 1980s with the discovery of backpropagation (thanks to Rumelhart, Hinton, and Williams!) and several other inventions, including Hopfield networks, neocognition, convolutional and recurrent neural networks, and Q-learning. Of course, rapid strides of evolution started taking place in Machine Learning too since the 1990s with the discovery of random forests, support vector machines, long short-term memory networks (LSTMs), and development and release of frameworks in both machine and Deep Learning including torch, theano, tensorflow, scikit-learn, and so on. We also saw the rise of intelligent systems including IBM Watson, DeepFace, and AlphaGo. Indeed the journey has been quite a roller coaster ride and there's still miles to go in this journey. Take a moment and reflect on this evolutionary journey and let's talk about the purpose of this journey. Why and when should we really make machines learn?

## Why Make Machines Learn?

We have discussed a fair bit about why we need Machine Learning in a previous section when we address the issue of trying to leverage data to make data-driven decisions at scale using learning algorithms without focusing too much on manual efforts and fixed rule-based systems. In this section, we discuss in more detail why and when should we make machines learn. There are several real-world tasks and problems that humans, businesses, and organizations try to solve day in and day out for our benefit. There are several scenarios when it might be beneficial to make machines learn and some of them are mentioned as follows.

- Lack of sufficient human expertise in a domain (e.g., simulating navigations in unknown territories or even spatial planets).
- Scenarios and behavior can keep changing over time (e.g., availability of infrastructure in an organization, network connectivity, and so on).
- Humans have sufficient expertise in the domain but it is extremely difficult to formally explain or translate this expertise into computational tasks (e.g., speech recognition, translation, scene recognition, cognitive tasks, and so on).
- Addressing domain specific problems at scale with huge volumes of data with too many complex conditions and constraints.

The previously mentioned scenarios are just several examples where making machines learn would be more effective than investing time, effort, and money in trying to build sub-par intelligent systems that might be limited in scope, coverage, performance, and intelligence. We as humans and domain experts already have enough knowledge about the world and our respective domains, which can be objective, subjective, and sometimes even intuitive. With the availability of large volumes of historical data, we can leverage the Machine Learning paradigm to make machines perform specific tasks by gaining enough experience by observing patterns in data over a period of time and then use this experience in solving tasks in the future with minimal manual intervention. The core idea remains to make machines solve tasks that can be easily defined intuitively and almost involuntarily but extremely hard to define formally.

## Formal Definition

We are now ready to define Machine Learning formally. You may have come across multiple definitions of Machine Learning by now which include, techniques to make machines intelligent, automation on steroids, automating the task of automation itself, the sexiest job of the 21st century, making computers learn by themselves and countless others! While all of them are good quotes and true to certain extents, the best way to define Machine Learning would be to start from the basics of Machine Learning as defined by renowned professor Tom Mitchell in 1997.

The idea of Machine Learning is that there will be some learning algorithm that will help the machine learn from data. Professor Mitchell defined it as follows.

*“A computer program is said to learn from experience  $E$  with respect to some class of tasks  $T$  and performance measure  $P$ , if its performance at tasks in  $T$ , as measured by  $P$ , improves with experience  $E$ .”*

While this definition might seem daunting at first, I ask you go read through it a couple of times slowly focusing on the three parameters— $T$ ,  $P$ , and  $E$ —which are the main components of any learning algorithm, as depicted in Figure 1-3.

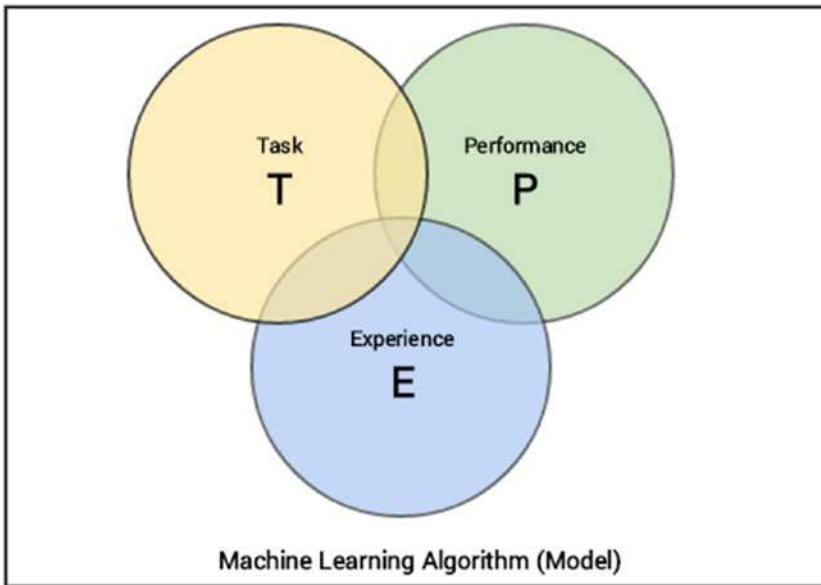

**Figure 1-3.** *Defining the components of a learning algorithm*

We can simplify the definition as follows. Machine Learning is a field that consists of learning algorithms that:

- Improve their performance  $P$
- At executing some task  $T$
- Over time with experience  $E$

While we discuss at length each of these entities in the following sections, we will not spend time in formally or mathematically defining each of these entities since the scope of the book is more toward applied or practical Machine Learning. If you consider our real-world problem from earlier, one of the tasks  $T$  could be predicting outages for our infrastructure; experience  $E$  would be what our Machine Learning model would gain over time by observing patterns from various device data attributes; and the performance of the model  $P$  could be measured in various ways like how accurately the model predicts outages.

## Defining the Task, $T$

We had discussed briefly in the previous section about the task,  $T$ , which can be defined in a two-fold approach. From a problem standpoint, the task,  $T$ , is basically the real-world problem to be solved at hand, which could be anything from finding the best marketing or product mix to predicting infrastructure failures. In the Machine Learning world, it is best if you can define the task as concretely as possible such that you talk about what the exact problem is which you are planning to solve and how you could define or formulate the problem into a specific Machine Learning task.

Machine Learning based tasks are difficult to solve by conventional and traditional programming approaches. A task,  $T$ , can usually be defined as a Machine Learning task based on the process or workflow that the system should follow to operate on data points or samples. Typically a data sample or point will consist of multiple data attributes (also called features in Machine Learning lingo) just like the various device parameters we mentioned in our problem for DSS Company earlier. A typical data point can be

denoted by a vector (Python list) such that each element in the vector is for a specific data feature or attribute. We discuss more about features and data points in detail in a future section as well as in Chapter 4, “Feature Engineering and Selection”.

Coming back to the typical tasks that could be classified as Machine Learning tasks, the following list describes some popular tasks.

- **Classification or categorization:** This typically encompasses the list of problems or tasks where the machine has to take in data points or samples and assign a specific class or category to each sample. A simple example would be classifying animal images into dogs, cats, and zebras.
- **Regression:** These types of tasks usually involve performing a prediction such that a real numerical value is the output instead of a class or category for an input data point. The best way to understand a regression task would be to take the case of a real-world problem of predicting housing prices considering the plot area, number of floors, bathrooms, bedrooms, and kitchen as input attributes for each data point.
- **Anomaly detection:** These tasks involve the machine going over event logs, transaction logs, and other data points such that it can find anomalous or unusual patterns or events that are different from the normal behavior. Examples for this include trying to find denial of service attacks from logs, indications of fraud, and so on.
- **Structured annotation:** This usually involves performing some analysis on input data points and adding structured metadata as annotations to the original data that depict extra information and relationships among the data elements. Simple examples would be annotating text with their parts of speech, named entities, grammar, and sentiment. Annotations can also be done for images like assigning specific categories to image pixels, annotate specific areas of images based on their type, location, and so on.
- **Translation:** Automated machine translation tasks are typically of the nature such that if you have input data samples belonging to a specific language, you translate it into output having another desired language. Natural language based translation is definitely a huge area dealing with a lot of text data.
- **Clustering or grouping:** Clusters or groups are usually formed from input data samples by making the machine learn or observe inherent latent patterns, relationships and similarities among the input data points themselves. Usually there is a lack of pre-labeled or pre-annotated data for these tasks hence they form a part of unsupervised Machine Learning (which we will discuss later on). Examples would be grouping similar products, events and entities.
- **Transcriptions:** These tasks usually entail various representations of data that are usually continuous and unstructured and converting them into more structured and discrete data elements. Examples include speech to text, optical character recognition, images to text, and so on.

This should give you a good idea of typical tasks that are often solved using Machine Learning, but this list is definitely not an exhaustive one as the limits of tasks are indeed endless and more are being discovered with extensive research over time.



## Defining the Experience, E

At this point, you know that any learning algorithm typically needs data to learn over time and perform a specific task, which we named as  $T$ . The process of consuming a dataset that consists of data samples or data points such that a learning algorithm or model learns inherent patterns is defined as the experience,  $E$  which is gained by the learning algorithm. Any experience that the algorithm gains is from data samples or data points and this can be at any point of time. You can feed it data samples in one go using historical data or even supply fresh data samples whenever they are acquired.

Thus, the idea of a model or algorithm gaining experience usually occurs as an iterative process, also known as training the model. You could think of the model to be an entity just like a human being which gains knowledge or experience through data points by observing and learning more and more about various attributes, relationships and patterns present in the data. Of course, there are various forms and ways of learning and gaining experience including supervised, unsupervised, and reinforcement learning but we will discuss learning methods in a future section. For now, take a step back and remember the analogy we drew that when a machine truly learns, it is based on data which is fed to it from time to time thus allowing it to gain experience and knowledge about the task to be solved, such that it can use this experience,  $E$ , to predict or solve the same task,  $T$ , in the future for previously unseen data points.

## Defining the Performance, P

Let's say we have a Machine Learning algorithm that is supposed to perform a task,  $T$ , and is gaining experience,  $E$ , with data points over a period of time. But how do we know if it's performing well or behaving the way it is supposed to behave? This is where the performance,  $P$ , of the model comes into the picture. The performance,  $P$ , is usually a quantitative measure or metric that's used to see how well the algorithm or model is performing the task,  $T$ , with experience,  $E$ . While performance metrics are usually standard metrics that have been established after years of research and development, each metric is usually computed specific to the task,  $T$ , which we are trying to solve at any given point of time.

Typical performance measures include accuracy, precision, recall, F1 score, sensitivity, specificity, error rate, misclassification rate, and many more. Performance measures are usually evaluated on training data samples (used by the algorithm to gain experience,  $E$ ) as well as data samples which it has not seen or learned from before, which are usually known as validation and test data samples. The idea behind this is to generalize the algorithm so that it doesn't become too biased only on the training data points and performs well in the future on newer data points. More on training, validation, and test data will be discussed when we talk about model building and validation.

While solving any Machine Learning problem, most of the times, the choice of performance measure,  $P$ , is either accuracy, F1 score, precision, and recall. While this is true in most scenarios, you should always remember that sometimes it is difficult to choose performance measures that will accurately be able to give us an idea of how well the algorithm is performing based on the actual behavior or outcome which is expected from it. A simple example would be that sometimes we would want to penalize misclassification or false positives more than correct hits or predictions. In such a scenario, we might need to use a modified cost function or priors such that we give a scope to sacrifice hit rate or overall accuracy for more accurate predictions with lesser false positives. A real-world example would be an intelligent system that predicts if we should give a loan to a customer. It's better to build the system in such a way that it is more cautious against giving a loan than denying one. The simple reason is because one big mistake of giving a loan to a potential defaulter can lead to huge losses as compared to denying several smaller loans to potential customers. To conclude, you need to take into account all parameters and attributes involved in task,  $T$ , such that you can decide on the right performance measures,  $P$ , for your system.

## A Multi-Disciplinary Field

We have formally introduced and defined Machine Learning in the previous section, which should give you a good idea about the main components involved with any learning algorithm. Let's now shift our perspective to Machine Learning as a domain and field. You might already know that Machine Learning is mostly considered to be a sub-field of artificial intelligence and even computer science from some perspectives. Machine Learning has concepts that have been derived and borrowed from multiple fields over a period of time since its inception, making it a true multi-disciplinary or inter-disciplinary field. Figure 1-4 should give you a good idea with regard to the major fields that overlap with Machine Learning based on concepts, methodologies, ideas, and techniques. An important point to remember here is that this is definitely not an exhaustive list of domains or fields but pretty much depicts the major fields associated in tandem with Machine Learning.

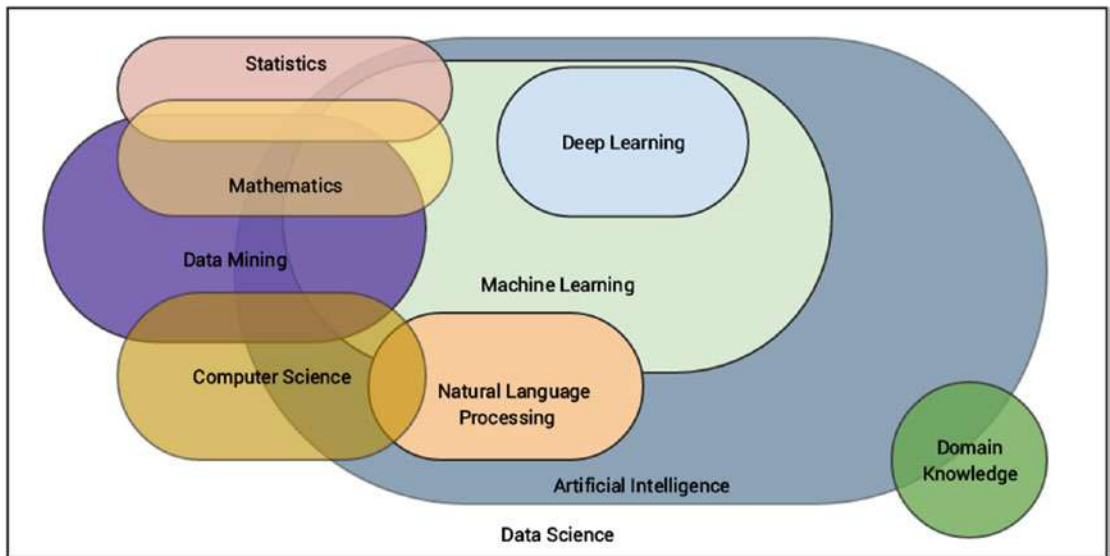

**Figure 1-4.** *Machine Learning: a true multi-disciplinary field*

The major domains or fields associated with Machine Learning include the following, as depicted in Figure 1-4. We will discuss each of these fields in upcoming sections.

- Artificial intelligence
- Natural language processing
- Data mining
- Mathematics
- Statistics
- Computer science
- Deep Learning
- Data Science

You could say that *Data Science* is like a broad inter-disciplinary field spanning across all the other fields which are sub-fields inside it. Of course this is just a simple generalization and doesn't strictly indicate that it is inclusive of all other other fields as a superset, but rather borrows important concepts and methodologies from them. The basic idea of Data Science is once again processes, methodologies, and techniques to extract information from data and domain knowledge. This is a big part of what we discuss in an upcoming section when we talk about Data Science in further details.

Coming back to Machine Learning, ideas of pattern recognition and basic *data mining* methodologies like *knowledge discovery of databases* (KDD) came into existence when relational databases were very prominent. These areas focus more on the ability and technique to mine for information from large datasets, such that you can get patterns, knowledge, and insights of interest. Of course, KDD is a whole process by itself that includes data acquisition, storage, warehousing, processing, and analysis. Machine Learning borrows concepts that are more concerned with the analysis phase, although you do need to go through the other steps to reach to the final stage. *Data mining* is again a interdisciplinary or multi-disciplinary field and borrows concepts from computer science, mathematics, and statistics. The consequence of this is the fact that computational statistics form an important part of most Machine Learning algorithms and techniques.

*Artificial intelligence* (AI) is the superset consisting of Machine Learning as one of its specialized areas. The basic idea of AI is the study and development of intelligence as exhibited by machines based on their perception of their environment, input parameters and attributes and their response such that they can perform desired tasks based on expectations. AI itself is a truly massive field which is itself inter-disciplinary. It draws on concepts from mathematics, statistics, computer science, cognitive sciences, linguistics, neuroscience, and many more. Machine Learning is more concerned with algorithms and techniques that can be used to understand data, build representations, and perform tasks such as predictions. Another major sub-field under AI related to Machine Learning is *natural language processing* (NLP) which borrows concepts heavily from computational linguistics and computer science. *Text Analytics* is a prominent field today among analysts and data scientists to extract, process and understand natural human language. Combine NLP with AI and Machine Learning and you get chatbots, machine translators, and virtual personal assistants, which are indeed the future of innovation and technology!

Coming to *Deep Learning*, it is a subfield of Machine Learning itself which deals more with techniques related to representational learning such that it improves with more and more data by gaining more experience. It follows a layered and hierarchical approach such that it tries to represent the given input attributes and its current surroundings, using a nested layered hierarchy of concept representations such that, each complex layer is built from another layer of simpler concepts. Neural networks are something which is heavily utilized by Deep Learning and we will look into Deep Learning in a bit more detail in a future section and solve some real-world problems later on in this book.

*Computer science* is pretty much the foundation for most of these domains dealing with study, development, engineering, and programming of computers. Hence we won't be expanding too much on this but you should definitely remember the importance of computer science for Machine Learning to exist and be easily applied to solve real-world problems. This should give you a good idea about the broad landscape of the multi-disciplinary field of Machine Learning and how it is connected across multiple related and overlapping fields. We will discuss some of these fields in more detail in upcoming sections and cover some basic concepts in each of these fields wherever necessary.

Let's look at some core fundamentals of Computer Science in the following section.

## Computer Science

The field of computer science (CS) can be defined as the study of the science of understanding computers. This involves study, research, development, engineering, and experimentation of areas dealing with understanding, designing, building, and using computers. This also involves extensive design and development of algorithms and programs that can be used to make the computer perform computations and tasks as desired. There are mainly two major areas or fields under computer science, as follows.

- Theoretical computer science
- Applied or practical computer science

The two major areas under computer science span across multiple fields and domains wherein each field forms a part or a sub-field of computer science. The main essence of computer science includes formal languages, automata and theory of computation, algorithms, data structures, computer design and architecture, programming languages, and software engineering principles.

## Theoretical Computer Science

*Theoretical computer science* is the study of theory and logic that tries to explain the principles and processes behind computation. This involves understanding the theory of computation which talks about how computation can be used efficiently to solve problems. Theory of computation includes the study of formal languages, automata, and understanding complexities involved in computations and algorithms. Information and coding theory is another major field under theoretical CS that has given us domains like signal processing, cryptography, and data compression. Principles of programming languages and their analysis is another important aspect that talks about features, design, analysis, and implementations of various programming languages and how compilers and interpreters work in understanding these languages. Last but never the least, data structures and algorithms are the two fundamental pillars of theoretical CS used extensively in computational programs and functions.

## Practical Computer Science

*Practical computer science* also known as applied computer science is more about tools, methodologies, and processes that deal with applying concepts and principles from computer science in the real world to solve practical day-to-day problems. This includes emerging sub-fields like artificial intelligence, Machine Learning, computer vision, Deep Learning, natural language processing, data mining, and robotics and they try to solve complex real-world problems based on multiple constraints and parameters and try to emulate tasks that require considerable human intelligence and experience. Besides these, we also have well-established fields, including computer architecture, operating systems, digital logic and design, distributed computing, computer networks, security, databases, and software engineering.

## Important Concepts

These are several concepts from computer science that you should know and remember since they would be useful as foundational concepts to understand the other chapters, concepts, and examples better. It's not an exhaustive list but should pretty much cover enough to get started.

## Algorithms

An *algorithm* can be described as a sequence of steps, operations, computations, or functions that can be executed to carry out a specific task. They are basically methods to describe and represent a computer program formally through a series of operations, which are often described using plain natural language, mathematical symbols, and diagrams. Typically flowcharts, pseudocode, and natural language are used extensively to represent algorithms. An algorithm can be as simple as adding two numbers and as complex as computing the inverse of a matrix.

## Programming Languages

A *programming language* is a language that has its own set of symbols, words, tokens, and operators having their own significance and meaning. Thus syntax and semantics combine to form a formal language in itself. This language can be used to write computer programs, which are basically real-world implementations of algorithms that can be used to specify specific instructions to the computer such that it carries our necessary computation and operations. Programming languages can be low level like C and Assembly or high level languages like Java and Python.

## Code

This is basically source code that forms the foundation of computer programs. Code is written using programming languages and consists of a collection of computer statements and instructions to make the computer perform specific desired tasks. Code helps convert algorithms into programs using programming languages. We will be using Python to implement most of our real-world Machine Learning solutions.

## Data Structures

*Data structures* are specialized structures that are used to manage data. Basically they are real-world implementations for abstract data type specifications that can be used to store, retrieve, manage, and operate on data efficiently. There is a whole suite of data structures like arrays, lists, tuples, records, structures, unions, classes, and many more. We will be using Python data structures like lists, arrays, dataframes, and dictionaries extensively to operate on real-world data!

## Data Science

The field of *Data Science* is a very diverse, inter-disciplinary field which encompasses multiple fields that we depicted in Figure 1-4. Data Science basically deals with principles, methodologies, processes, tools, and techniques to gather knowledge or information from data (structured as well as unstructured). Data Science is more of a compilation of processes, techniques, and methodologies to foster a data-driven decision based culture. In fact Drew Conway's "Data Science Venn Diagram," depicted in Figure 1-5, shows the core components and essence of Data Science, which in fact went viral and became insanely popular!

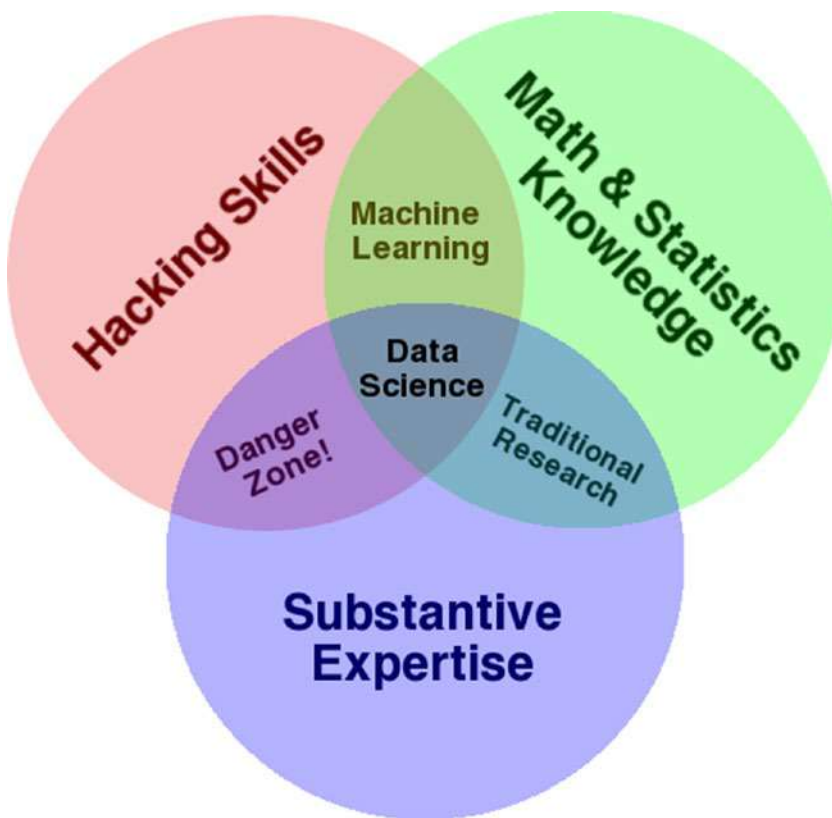

**Figure 1-5.** Drew Conway's Data Science Venn diagram

Figure 1-5 is quite intuitive and easy to interpret. Basically there are three major components and Data Science sits at the intersection of them. *Math and statistics knowledge* is all about applying various computational and quantitative math and statistical based techniques to extract insights from data. *Hacking skills* basically indicate the capability of handling, processing, manipulating and wrangling data into easy to understand and analyzable formats. *Substantive expertise* is basically the actual real-world domain expertise which is extremely important when you are solving a problem because you need to know about various factors, attributes, constraints, and knowledge related to the domain besides your expertise in data and algorithms.

Thus Drew rightly points out that Machine Learning is a combination of expertise on data hacking skills, math, and statistical learning methods and for Data Science, you need some level of domain expertise and knowledge along with Machine Learning. You can check out Drew's personal insights in his article at <http://drewconway.com/zia/2013/3/26/the-data-science-venn-diagram>, where talks all about the Data Science Venn diagram. Besides this, we also have Brendan Tierney, who talks about the true nature of Data Science being a multi-disciplinary field with his own depiction, as shown in Figure 1-6.

# Data Science Is Multidisciplinary

By Brendan Tierney, 2012

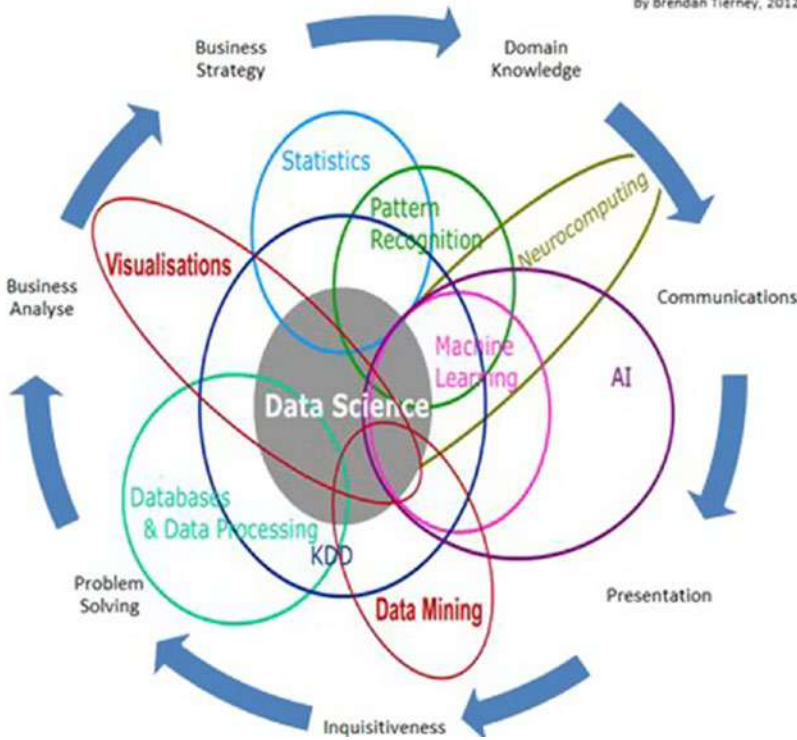

**Figure 1-6.** Brendan Tierney's depiction of Data Science as a true multi-disciplinary field

If you observe his depiction closely, you will see a lot of the domains mentioned here are what we just talked about in the previous sections and matches a substantial part of Figure 1-4. You can clearly see Data Science being the center of attention and drawing parts from all the other fields and Machine Learning as a sub-field.

## Mathematics

The field of mathematics deals with numbers, logic, and formal systems. The best definition of mathematics was coined by Aristotle as “The science of quantity”. The scope of mathematics as a scientific field is huge spanning across areas including algebra, trigonometry, calculus, geometry, and number theory just to name a few major fields. Linear algebra and probability are two major sub-fields under mathematics that are used extensively in Machine Learning and we will be covering a few important concepts from them in this section. Our major focus will always be on practical Machine Learning, and applied mathematics is an important aspect for the same. Linear algebra deals with mathematical objects and structures like vectors, matrices, lines, planes, hyperplanes, and vector spaces. The theory of probability is a mathematical field and framework used for studying and quantifying events of chance and uncertainty and deriving theorems and axioms from the same. These laws and axioms help us in reasoning, understanding, and quantifying uncertainty and its effects in any real-world system or scenario, which helps us in building our Machine Learning models by leveraging this framework.

## Important Concepts

In this section, we discuss some key terms and concepts from applied mathematics, namely linear algebra and probability theory. These concepts are widely used across Machine Learning and form some of the foundational structures and principles across Machine Learning algorithms, models, and processes.

### Scalar

A *scalar* usually denotes a single number as opposed to a collection of numbers. A simple example might be  $x = 5$  or  $x \in R$ , where  $x$  is the scalar element pointing to a single number or a real-valued single number.

### Vector

A *vector* is defined as a structure that holds an array of numbers which are arranged in order. This basically means the order or sequence of numbers in the collection is important. Vectors can be mathematically denoted as  $x = [x_1, x_2, \dots, x_n]$ , which basically tells us that  $x$  is a one-dimensional vector having  $n$  elements in the array. Each element can be referred to using an array index determining its position in the vector. The following snippet shows us how we can represent simple vectors in Python.

```
In [1]: x = [1, 2, 3, 4, 5]
...: x
Out[1]: [1, 2, 3, 4, 5]
In [2]: import numpy as np
...: x = np.array([1, 2, 3, 4, 5])
...:
...: print(x)
...: print(type(x))
[1 2 3 4 5]
<class 'numpy.ndarray'>
```

Thus you can see that Python lists as well as numpy based arrays can be used to represent vectors. Each row in a dataset can act as a one-dimensional vector of  $n$  attributes, which can serve as inputs to learning algorithms.

### Matrix

A *matrix* is a two-dimensional structure that basically holds numbers. It's also often referred to as a 2D array. Each element can be referred to using a row and column index as compared to a single vector index in case

of vectors. Mathematically, you can depict a matrix as  $M = \begin{bmatrix} m_{11} & m_{12} & m_{13} \\ m_{21} & m_{22} & m_{23} \\ m_{31} & m_{32} & m_{33} \end{bmatrix}$  such that  $M$  is a 3 x 3 matrix

having three rows and three columns and each element is denoted by  $m_{rc}$  such that  $r$  denotes the row index and  $c$  denotes the column index. Matrices can be easily represented as list of lists in Python and we can leverage the numpy array structure as depicted in the following snippet.

```
In [3]: m = np.array([[1, 5, 2],
...:                  [4, 7, 4],
...:                  [2, 0, 9]])
```



```
In [4]: # view matrix
...: print(m)
[[1 5 2]
 [4 7 4]
 [2 0 9]]
```

```
In [5]: # view dimensions
...: print(m.shape)
(3, 3)
```

Thus you can see how we can easily leverage numpy arrays to represent matrices. You can think of a dataset with rows and columns as a matrix such that the data features or attributes are represented by columns and each row denotes a data sample. We will be using the same analogy later on in our analyses. Of course, you can perform matrix operations like add, subtract, products, inverse, transpose, determinants, and many more. The following snippet shows some popular matrix operations.

```
In [9]: # matrix transpose
...: print('Matrix Transpose:\n', m.transpose(), '\n')
...:
...: # matrix determinant
...: print ('Matrix Determinant:', np.linalg.det(m), '\n')
...:
...: # matrix inverse
...: m_inv = np.linalg.inv(m)
...: print ('Matrix inverse:\n', m_inv, '\n')
...:
...: # identity matrix (result of matrix x matrix_inverse)
...: iden_m = np.dot(m, m_inv)
...: iden_m = np.round(np.abs(iden_m), 0)
...: print ('Product of matrix and its inverse:\n', iden_m)
...:
```

Matrix Transpose:

```
[[1 4 2]
 [5 7 0]
 [2 4 9]]
```

Matrix Determinant: -105.0

Matrix inverse:

```
[[ -0.6      0.42857143 -0.05714286]
 [ 0.26666667 -0.04761905 -0.03809524]
 [ 0.13333333 -0.0952381  0.12380952]]
```

Product of matrix and its inverse:

```
[[ 1.  0.  0.]
 [ 0.  1.  0.]
 [ 0.  0.  1.]]
```

This should give you a good idea to get started with matrices and their basic operations. More on this is covered in Chapter 2, “The Python Machine Learning Ecosystem”.

## Tensor

You can think of a *tensor* as a generic array. Tensors are basically arrays with a variable number of axes. An element in a three-dimensional tensor  $T$  can be denoted by  $T_{x,y,z}$  where  $x, y, z$  denote the three axes for specifying element  $T$ .

## Norm

The *norm* is a measure that is used to compute the size of a vector often also defined as the measure of distance from the origin to the point denoted by the vector. Mathematically, the  $p$ th norm of a vector is denoted as follows.

$$L^p = \|x_p\| = \left( \sum_i |x_i|^p \right)^{\frac{1}{p}}$$

Such that  $p \geq 1$  and  $p \in R$ . Popular norms in Machine Learning include the  $L^1$  norm used extensively in Lasso regression models and the  $L^2$  norm, also known as the Euclidean norm, used in ridge regression models.

## Eigen Decomposition

This is basically a matrix decomposition process such that we decompose or break down a matrix into a set of eigen vectors and eigen values. The eigen decomposition of a matrix can be mathematically denoted by  $M = V \text{diag}(\lambda) V^{-1}$  such that the matrix  $M$  has a total of  $n$  linearly independent eigen vectors represented as  $\{v^{(1)}, v^{(2)}, \dots, v^{(n)}\}$  and their corresponding eigen values can be represented as  $\{\lambda_1, \lambda_2, \dots, \lambda_n\}$ . The matrix  $V$  consists of one eigen vector per column of the matrix i.e.,  $V = [v^{(1)}, v^{(2)}, \dots, v^{(n)}]$  and the vector  $\lambda$  consists of all the eigen values together i.e.,  $\lambda = [\lambda_1, \lambda_2, \dots, \lambda_n]$ .

An eigen vector of the matrix is defined as a non-zero vector such that on multiplying the matrix by the eigen vector, the result only changes the scale of the eigen vector itself, i.e., the result is a scalar multiplied by the eigen vector. This scalar is known as the eigen value corresponding to the eigen vector. Mathematically this can be denoted by  $Mv = \lambda v$  where  $M$  is our matrix,  $v$  is the eigen vector and  $\lambda$  is the corresponding eigen value. The following Python snippet depicts how to extract eigen values and eigen vectors from a matrix.

```
In [4]: # eigendecomposition
...: m = np.array([[1, 5, 2],
...:               [4, 7, 4],
...:               [2, 0, 9]])
...:
...: eigen_vals, eigen_vecs = np.linalg.eig(m)
...:
...: print('Eigen Values:', eigen_vals, '\n')
...: print('Eigen Vectors:\n', eigen_vecs)
...:
Eigen Values: [ -1.32455532  11.32455532   7.          ]
```

```
Eigen Vectors:
[[-0.91761521  0.46120352 -0.46829291]
 [ 0.35550789  0.79362022 -0.74926865]
 [ 0.17775394  0.39681011  0.46829291]]
```

## Singular Value Decomposition

The process of *singular value decomposition*, also known as SVD, is another matrix decomposition or factorization process such that we are able to break down a matrix to obtain singular vectors and singular values. Any real matrix will always be decomposed by SVD even if eigen decomposition may not be applicable in some cases. Mathematically, SVD can be defined as follows. Considering a matrix  $M$  having dimensions  $m \times n$  such that  $m$  denotes total rows and  $n$  denotes total columns, the SVD of the matrix can be represented with the following equation.

$$M_{m \times n} = U_{m \times m} S_{m \times n} V_{n \times n}^T$$

This gives us the following main components of the decomposition equation.

- $U_{m \times m}$  is an  $m \times m$  unitary matrix where each column represents a left singular vector
- $S_{m \times n}$  is an  $m \times n$  matrix with positive numbers on the diagonal, which can also be represented as a vector of the singular values
- $V_{n \times n}^T$  is an  $n \times n$  unitary matrix where each row represents a right singular vector

In some representations, the rows and columns might be interchanged but the end result should be the same, i.e.,  $U$  and  $V$  are always orthogonal. The following snippet shows a simple SVD decomposition in Python.

```
In [7]: # SVD
...: m = np.array([[1, 5, 2],
...:               [4, 7, 4],
...:               [2, 0, 9]])
...:
...: U, S, VT = np.linalg.svd(m)
...:
...: print('Getting SVD outputs:-\n')
...: print('U:\n', U, '\n')
...: print('S:\n', S, '\n')
...: print('VT:\n', VT, '\n')
...:
```

Getting SVD outputs:-

```
U:
[[ 0.3831556 -0.39279153  0.83600634]
 [ 0.68811254 -0.48239977 -0.54202545]
 [ 0.61619228  0.78294653  0.0854506  ]]
```

```
S:
[ 12.10668383  6.91783499  1.25370079]
```

```
VT:
[[ 0.36079164  0.55610321  0.74871798]
 [-0.10935467 -0.7720271  0.62611158]
 [-0.92621323  0.30777163  0.21772844]]
```

SVD as a technique and the singular values in particular are very useful in summarization based algorithms and various other methods like dimensionality reduction.

## Random Variable

Used frequently in probability and uncertainty measurement, a *random variable* is basically a variable that can take on various values at random. These variables can be of discrete or continuous type in general.

## Probability Distribution

A *probability distribution* is a distribution or arrangement that depicts the likelihood of a random variable or variables to take on each of its probable states. There are usually two main types of distributions based on the variable being discrete or continuous.

## Probability Mass Function

A *probability mass function*, also known as PMF, is a probability distribution over discrete random variables. Popular examples include the Poisson and binomial distributions.

## Probability Density Function

A *probability density function*, also known as PDF, is a probability distribution over continuous random variables. Popular examples include the normal, uniform, and student's T distributions.

## Marginal Probability

The *marginal probability* rule is used when we already have the probability distribution for a set of random variables and we want to compute the probability distribution for a subset of these random variables. For discrete random variables, we can define marginal probability as follows.

$$P(x) = \sum_y P(x, y)$$

For continuous random variables, we can define it using the integration operation as follows.

$$p(x) = \int p(x, y) dy$$

## Conditional Probability

The *conditional probability* rule is used when we want to determine the probability that an event is going to take place, such that another event has already taken place. This is mathematically represented as follows.

$$P(x | y) = \frac{P(x, y)}{P(y)}$$

This tells us the conditional probability of  $x$ , given that  $y$  has already taken place.

## Bayes Theorem

This is another rule or theorem which is useful when we know the probability of an event of interest  $P(A)$ , the conditional probability for another event based on our event of interest  $P(B | A)$  and we want to determine the conditional probability of our event of interest given the other event has taken place  $P(A | B)$ . This can be defined mathematically using the following expression.

$$P(A | B) = \frac{P(B | A)P(A)}{P(B)}$$

such that  $A$  and  $B$  are events and  $P(B) = \sum_x P(B | A)P(A)$ .

## Statistics

The field of statistics can be defined as a specialized branch of mathematics that consists of frameworks and methodologies to collect, organize, analyze, interpret, and present data. Generally this falls more under applied mathematics and borrows concepts from linear algebra, distributions, probability theory, and inferential methodologies. There are two major areas under statistics that are mentioned as follows.

- Descriptive statistics
- Inferential statistics

The core component of any statistical process is data. Hence typically data collection is done first, which could be in global terms, often called a population or a more restricted subset due to various constraints often known as a sample. Samples are usually collected manually, from surveys, experiments, data stores, and observational studies. From this data, various analyses are carried out using statistical methods.

*Descriptive statistics* is used to understand basic characteristics of the data using various aggregation and summarization measures to describe and understand the data better. These could be standard measures like mean, median, mode, skewness, kurtosis, standard deviation, variance, and so on. You can refer to any standard book on statistics to deep dive into these measures if you're interested. The following snippet depicts how to compute some essential descriptive statistical measures.

```
In [74]: # descriptive statistics
...: import scipy as sp
...: import numpy as np
...:
...: # get data
...: nums = np.random.randint(1,20, size=(1,15))[0]
...: print('Data: ', nums)
...:
...: # get descriptive stats
...: print ('Mean:', sp.mean(nums))
...: print ('Median:', sp.median(nums))
...: print ('Mode:', sp.stats.mode(nums))
...: print ('Standard Deviation:', sp.std(nums))
...: print ('Variance:', sp.var(nums))
...: print ('Skew:', sp.stats.skew(nums))
...: print ('Kurtosis:', sp.stats.kurtosis(nums))
...:
```

```
Data: [ 2 19  8 10 17 13 18  9 19 16  4 14 16 15  5]
Mean: 12.3333333333
Median: 14.0
Mode: ModeResult(mode=array([16]), count=array([2]))
Standard Deviation: 5.44875113112
Variance: 29.6888888889
Skew: -0.49820055879944575
Kurtosis: -1.0714842769550714
```

Libraries and frameworks like `pandas`, `scipy`, and `numpy` in general help us compute descriptive statistics and summarize data easily in Python. We cover these frameworks as well as basic data analysis and visualization in Chapters 2 and 3.

*Inferential statistics* are used when we want to test hypothesis, draw inferences, and conclusions about various characteristics of our data sample or population. Frameworks and techniques like hypothesis testing, correlation, and regression analysis, forecasting, and predictions are typically used for any form of inferential statistics. We look at this in much detail in subsequent chapters when we cover predictive analytics as well as time series based forecasting.

## Data Mining

The field of data mining involves processes, methodologies, tools and techniques to discover and extract patterns, knowledge, insights and valuable information from non-trivial datasets. Datasets are defined as non-trivial when they are substantially huge usually available from databases and data warehouses. Once again, data mining itself is a multi-disciplinary field, incorporating concepts and techniques from mathematics, statistics, computer science, databases, Machine Learning and Data Science. The term is a misnomer in general since the “mining” refers to the mining of actual insights or information from the data and not data itself! In the whole process of KDD or Knowledge Discovery in Databases, data mining is the step where all the analysis takes place.

In general, both KDD as well as data mining are closely linked with Machine Learning since they are all concerned with analyzing data to extract useful patterns and insights. Hence methodologies, concepts, techniques, and processes are shared among them. The standard process for data mining followed in the industry is known as the CRISP-DM model, which we discuss in more detail in an upcoming section in this chapter.

## Artificial Intelligence

The field of artificial Intelligence encompasses multiple sub-fields including Machine Learning, natural language processing, data mining, and so on. It can be defined as the art, science and engineering of making intelligent agents, machines and programs. The field aims to provide solutions for one simple yet extremely tough objective, “Can machines think, reason, and act like human beings?” AI in fact existed as early as the 1300s when people started asking such questions and conducting research and development on building tools that could work on concepts instead of numbers like a calculator does. Progress in AI took place in a steady pace with discoveries and inventions by Alan Turing, McCulloch, and Pitts Artificial Neurons. AI was revived once again after a slowdown till the 1980s with success of expert systems, the resurgence of neural networks thanks to Hopfield, Rumelhart, McClelland, Hinton, and many more. Faster and better computation thanks to Moore’s Law led to fields like data mining, Machine Learning and even Deep Learning come into prominence to solve complex problems that would otherwise have been impossible to solve using traditional approaches. Figure 1-7 shows some of the major facets under the broad umbrella of AI.

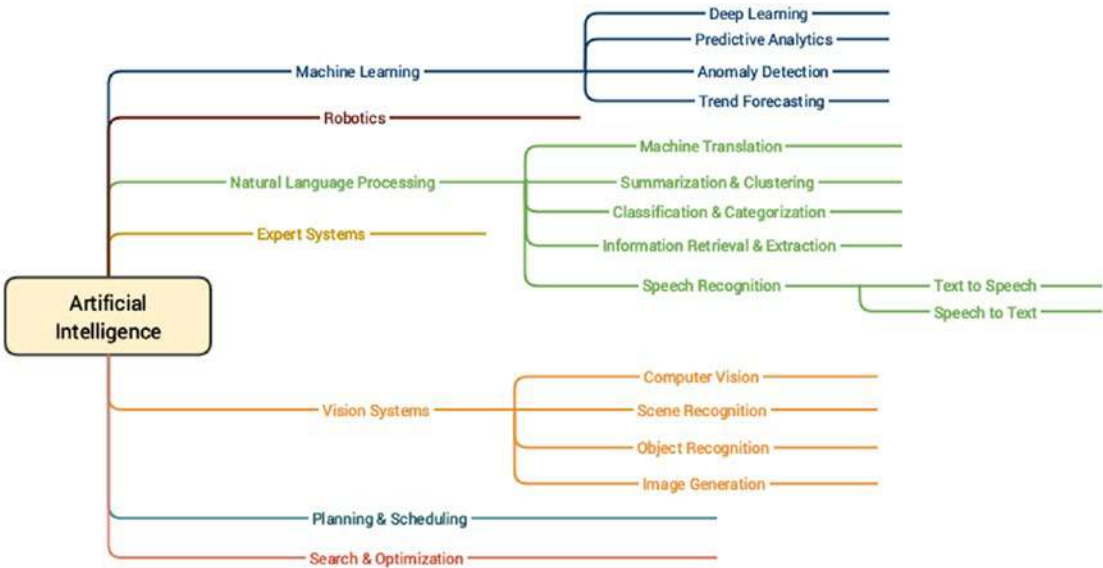

**Figure 1-7.** Diverse major facets under the AI umbrella

Some of the main objectives of AI include emulation of cognitive functions also known as cognitive learning, semantics, and knowledge representation, learning, reasoning, problem solving, planning, and natural language processing. AI borrows tools, concepts, and techniques from statistical learning, applied mathematics, optimization methods, logic, probability theory, Machine Learning, data mining, pattern recognition, and linguistics. AI is still evolving over time and a lot of innovation is being done in this field including some of the latest discoveries and inventions like self-driving cars, chatbots, drones, and intelligent robots.

## Natural Language Processing

The field of *Natural Language Processing* (NLP) is a multi-disciplinary field combining concepts from computational linguistics, computer science and artificial intelligence. NLP involves the ability to make machines process, understand, and interact with natural human languages. The major objective of applications or systems built using NLP is to enable interactions between machines and natural languages that have evolved over time. Major challenges in this aspect include knowledge and semantics representation, natural language understanding, generation, and processing. Some of the major applications of NLP are mentioned as follows.

- Machine translation
- Speech recognition
- Question answering systems
- Context recognition and resolution
- Text summarization
- Text categorization

- Information extraction
- Sentiment and emotion analysis
- Topic segmentation

Using techniques from NLP and text analytics, you can work on text data to process, annotate, classify, cluster, summarize, extract semantics, determine sentiment, and much more! The following example snippet depicts some basic NLP operations on textual data where we annotate a document (text sentence) with various components like parts of speech, phrase level tags, and so on based on its constituent grammar. You can refer to page 159 of *Text Analytics with Python* (Apress; Dipanjan Sarkar, 2016) for more details on constituency parsing.

```
from nltk.parse.stanford import StanfordParser

sentence = 'The quick brown fox jumps over the lazy dog'

# create parser object
scp = StanfordParser(path_to_jar='E:/stanford/stanford-parser-full-2015-04-20/stanford-
parser.jar',
                    path_to_models_jar='E:/stanford/stanford-parser-full-2015-04-20/stanford-
parser-3.5.2-models.jar')

# get parse tree
result = list(scp.raw_parse(sentence))
tree = result[0]

In [98]: # print the constituency parse tree
...: print(tree)
(ROOT
  (NP
    (NP (DT The) (JJ quick) (JJ brown) (NN fox))
    (NP
      (NP (NNS jumps))
      (PP (IN over) (NP (DT the) (JJ lazy) (NN dog))))))

In [99]: # visualize constituency parse tree
...: tree.draw()
```



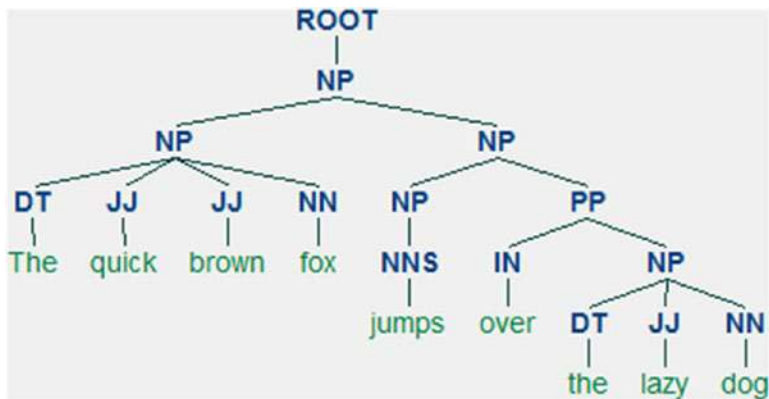

**Figure 1-8.** Constituency parse tree for our sample sentence

Thus you can clearly see that Figure 1-8 depicts the constituency grammar based parse tree for our sample sentence, which consists of multiple noun phrases (NP). Each phrase has several words that are also annotated with their own parts of speech (POS) tags. We cover more on processing and analyzing textual data for various steps in the Machine Learning pipeline as well as practical use cases in subsequent chapters.

## Deep Learning

The field of Deep Learning, as depicted earlier, is a sub-field of Machine Learning that has recently come into much prominence. Its main objective is to get Machine Learning research closer to its true goal of “making machines intelligent”. Deep Learning is often termed as a rebranded fancy term for neural networks. This is true to some extent but there is definitely more to Deep Learning than just basic neural networks. Deep Learning based algorithms involves the use of concepts from representation learning where various representations of the data are learned in different layers that also aid in automated feature extraction from the data. In simple terms, a Deep Learning based approach tries to build machine intelligence by representing data as a layered hierarchy of concepts, where each layer of concepts is built from other simpler layers. This layered architecture itself is one of the core components of any Deep Learning algorithm.

In any basic supervised Machine Learning technique, we basically try to learn a mapping between our data samples and our output and then try to predict output for newer data samples. Representational learning tries to understand the representations in the data itself besides learning mapping from inputs to outputs. This makes Deep Learning algorithms extremely powerful as compared to regular techniques, which require significant expertise in areas like feature extraction and engineering. Deep Learning is also extremely effective with regard to its performance as well as scalability with more and more data as compared to older Machine Learning algorithms. This is depicted in Figure 1-9 based on a slide from Andrew Ng’s talk at the Extract Data Conference.

## Why deep learning

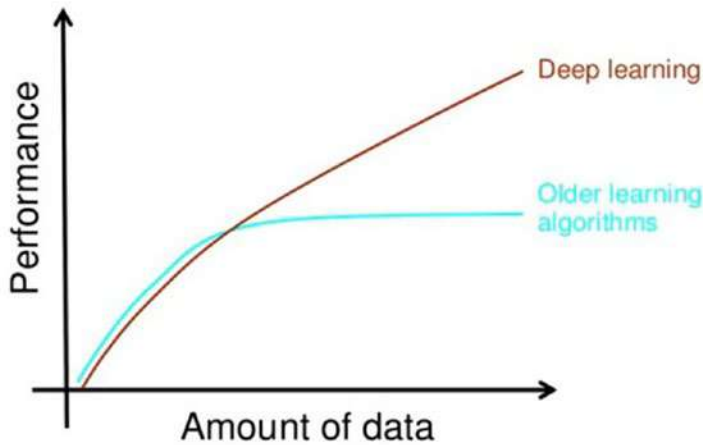

### How do data science techniques scale with amount of data?

*Figure 1-9. Performance comparison of Deep Learning and traditional Machine Learning by Andrew Ng*

Indeed, as rightly pointed out by Andrew Ng, there have been several noticeable trends and characteristics related to Deep Learning that we have noticed over the past decade. They are summarized as follows.

- Deep Learning algorithms are based on distributed representational learning and they start performing better with more data over time.
- Deep Learning could be said to be a rebranding of neural networks, but there is a lot into it compared to traditional neural networks.
- Better software frameworks like tensorflow, theano, caffe, mxnet, and keras, coupled with superior hardware have made it possible to build extremely complex, multi-layered Deep Learning models with huge sizes.
- Deep Learning has multiple advantages related to automated feature extraction as well as performing supervised learning operations, which have helped data scientists and engineers solve increasingly complex problems over time.

The following points describe the salient features of most Deep Learning algorithms, some of which we will be using in this book.

- Hierarchical layered representation of concepts. These concepts are also called features in Machine Learning terminology (data attributes).
- Distributed representational learning of the data happens through a multi-layered architecture (unsupervised learning).
- More complex and high-level features and concepts are derived from simpler, low-level features.

- A “deep” neural network usually is considered to have at least more than one hidden layer besides the input and output layers. Usually it consists of a minimum of three to four hidden layers.
- Deep architectures have a multi-layered architecture where each layer consists of multiple non-linear processing units. Each layer’s input is the previous layer in the architecture. The first layer is usually the input and the last layer is the output.
- Can perform automated feature extraction, classification, anomaly detection, and many other Machine Learning tasks.

This should give you a good foundational grasp of the concepts pertaining to Deep Learning. Suppose we had a real-world problem of object recognition from images. Figure 1-10 will give us a good idea of how typical Machine Learning and Deep Learning pipelines differ (Source: Yann LeCun).

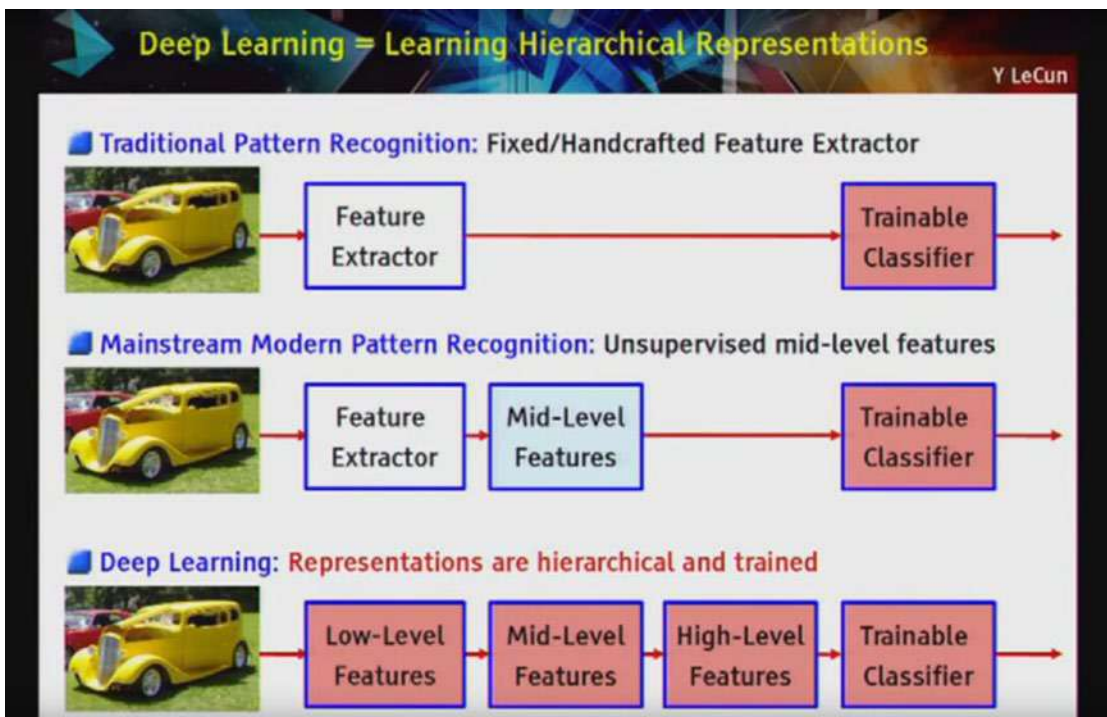

Figure 1-10. Comparing various learning pipelines by Yann LeCun

You can clearly see how Deep Learning methods involve a hierarchical layer representation of features and concept from the raw data as compared to other Machine Learning methods. We conclude this section with a brief coverage of some essential concepts pertaining to Deep Learning.

## Important Concepts

In this section, we discuss some key terms and concepts from Deep Learning algorithms and architecture. This should be useful in the future when you are building your own Deep Learning models.

## Artificial Neural Networks

An Artificial Neural Network (ANN) is a computational model and architecture that simulates biological neurons and the way they function in our brain. Typically, an ANN has layers of interconnected nodes. The nodes and their inter-connections are analogous to the network of neurons in our brain. A typical ANN has an input layer, an output layer, and at least one hidden layer between the input and output with inter-connections, as depicted in Figure 1-11

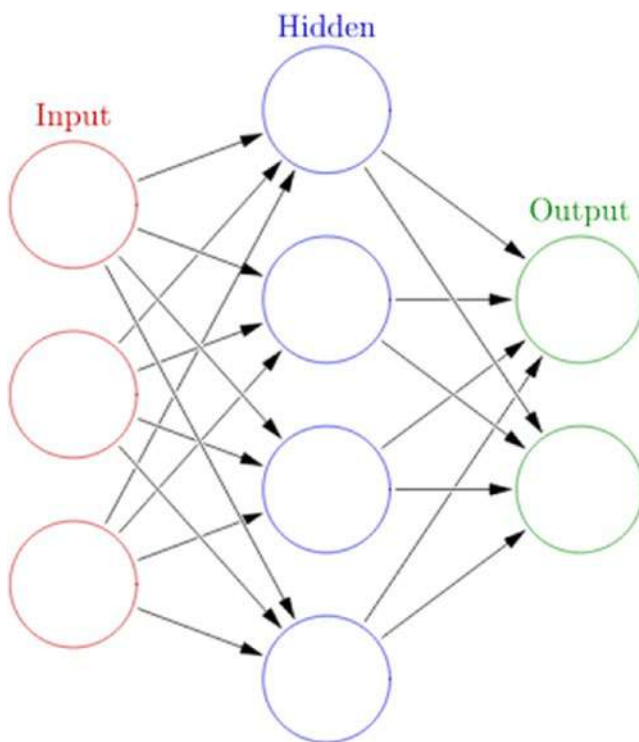

**Figure 1-11.** A typical artificial neural network

Any basic ANN will always have multiple layers of nodes, specific connection patterns and links between the layers, connection weights and activation functions for the nodes/neurons that convert weighted inputs to outputs. The process of learning for the network typically involves a cost function and the objective is to optimize the cost function (typically minimize the cost). The weights keep getting updated in the process of learning.

## Backpropagation

The backpropagation algorithm is a popular technique to train ANNs and it led to a resurgence in the popularity of neural networks in the 1980s. The algorithm typically has two main stages—propagation and weight updates. They are described briefly as follows.

1. Propagation
  - a. The input data sample vectors are propagated forward through the neural network to generate the output values from the output layer.
  - b. Compare the generated output vector with the actual/desired output vector for that input data vector.
  - c. Compute difference in error at the output units.
  - d. Backpropagate error values to generate deltas at each node/neuron.
  
2. Weight Update
  - a. Compute weight gradients by multiplying the output delta (error) and input activation.
  - b. Use learning rate to determine percentage of the gradient to be subtracted from original weight and update the weight of the nodes.

These two stages are repeated multiple times with multiple iterations/epochs until we get satisfactory results. Typically backpropagation is used along with optimization algorithms or functions like stochastic gradient descent.

## Multilayer Perceptrons

A multilayer perceptron, also known as MLP, is a fully connected, feed-forward artificial neural network with at least three layers (input, output, and at least one hidden layer) where each layer is fully connected to the adjacent layer. Each neuron usually is a non-linear functional processing unit. Backpropagation is typically used to train MLPs and even deep neural nets are MLPs when they have multiple hidden layers. Typically used for supervised Machine Learning tasks like classification.

## Convolutional Neural Networks

A convolutional neural network, also known as convnet or CNN, is a variant of the artificial neural network, which specializes in emulating functionality and behavior of our visual cortex. CNNs typically consist of the following three components.

- *Multiple convolutional layers*, which consist of multiple filters that are convolved across the height and width of the input data (e.g., image raw pixels) by basically computing a dot product to give a two-dimensional activation map. On stacking all the maps across all the filters, we end up getting the final output from a convolutional layer.

- *Pooling layers*, which are basically layers that perform non-linear down sampling to reduce the input size and number of parameters from the convolutional layer output to generalize the model more, prevent overfitting and reduce computation time. Filters go through the heights and width of the input and reduce it by taking an aggregate like sum, average, or max. Typical pooling components are average or max pooling.
- *Fully connected MLPs* to perform tasks such as image classification and object recognition.

A typical CNN architecture with all the components is depicted as follows in Figure 1-12, which is a LeNet CNN model (Source: deeplearning.net)

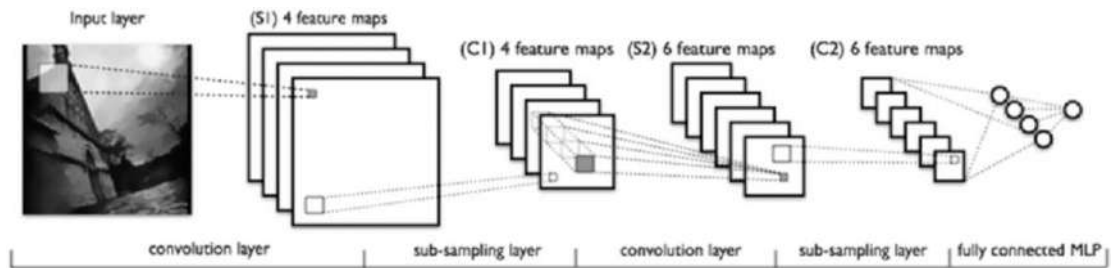

**Figure 1-12.** LeNet CNN model (Source: deeplearning.net)

## Recurrent Neural Networks

A recurrent neural network, also known as RNN, is a special type of an artificial neural network that allows persisting information based on past knowledge by using a special type of looped architecture. They are used a lot in areas related to data with sequences like predicting the next word of a sentence. These looped networks are called recurrent because they perform the same operations and computation for each and every element in a sequence of input data. RNNs have memory that helps in capturing information from past sequences. Figure 1-13 (Source: Colah's blog at <http://colah.github.io/posts/2015-08-Understanding-LSTMs/>) shows the typical structure of a RNN and how it works by unrolling the network based on input sequence length to be fed at any point in time.

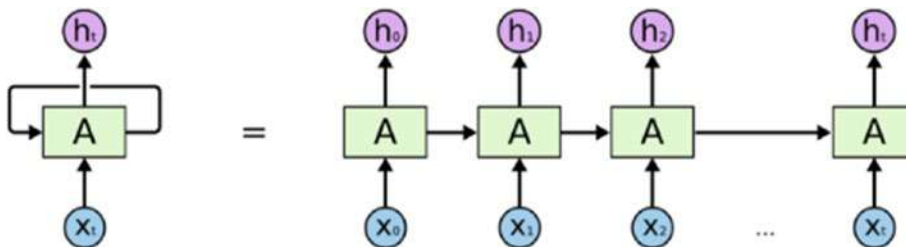

**An unrolled recurrent neural network.**

**Figure 1-13.** A recurrent neural network (Source: Colah's Blog)

Figure 1-13 clearly depicts how the unrolled network will accept sequences of length  $t$  in each pass of the input data and operate on the same.

## Long Short-Term Memory Networks

RNNs are good in working on sequence based data but as the sequences start increasing, they start losing historical context over time in the sequence and hence outputs are not always what is desired. This is where Long Short-Term Memory Networks, popularly known as LSTMs, come into the picture! Introduced by Hochreiter & Schmidhuber in 1997, LSTMs can remember information from really long sequence based data and prevent issues like the vanishing gradient problem, which typically occurs in ANNs trained with backpropagation. LSTMs usually consist of three or four gates, including input, output, and a special forget gate. Figure 1-14 shows a high-level pictorial representation of a single LSTM cell.

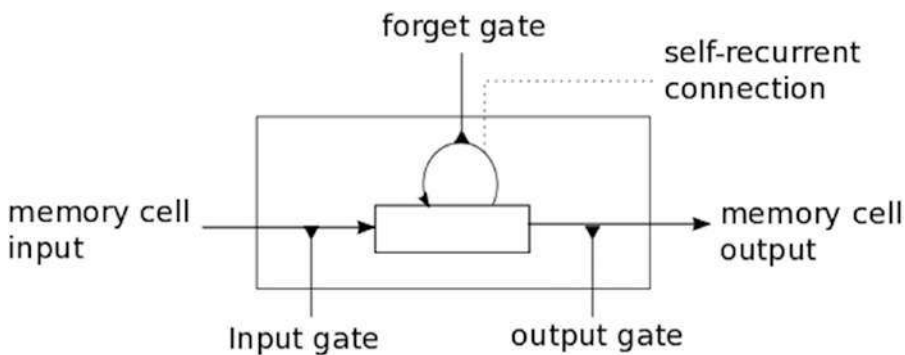

**Figure 1-14.** An LSTM cell (Source: *deeplearning.net*)

The input gate usually can allow or deny incoming signals or inputs to alter the memory cell state. The output gate usually propagates the value to other neurons as needed. The forget gate controls the memory cell's self-recurrent connection to remember or forget previous states as necessary. Multiple LSTM cells are usually stacked in any Deep Learning network to solve real-world problems like sequence prediction.

## Autoencoders

An autoencoder is a specialized Artificial Neural Network that is primarily used for performing unsupervised Machine Learning tasks. Its main objective is to learn data representations, approximations, and encodings. Autoencoders can be used for building generative models, performing dimensionality reduction, and detecting anomalies.

## Machine Learning Methods

Machine Learning has multiple algorithms, techniques, and methodologies that can be used to build models to solve real-world problems using data. This section tries to classify these Machine Learning methods under some broad categories to give some sense to the overall landscape of Machine Learning methods that are ultimately used to perform specific Machine Learning tasks we discussed in a previous section. Typically the same Machine Learning methods can be classified in multiple ways under multiple umbrellas. Following are some of the major broad areas of Machine Learning methods.

1. Methods based on the amount of human supervision in the learning process
  - a. Supervised learning
  - b. Unsupervised learning
  - c. Semi-supervised learning
  - d. Reinforcement learning
2. Methods based on the ability to learn from incremental data samples
  - a. Batch learning
  - b. Online learning
3. Methods based on their approach to generalization from data samples
  - a. Instance based learning
  - b. Model based learning

We briefly cover the various types of learning methods in the following sections to build a good foundation with regard to Machine Learning methods and the type of tasks they usually solve. This should give you enough knowledge to start understanding which methods should be applied in what scenarios when we tackle various real-world use cases and problems in the subsequent chapters of the book.

---

■ Discussing mathematical details and internals of each and every Machine Learning algorithm would be out of the current scope and intent of the book, since the focus is more on solving real-world problems by applying Machine Learning and not on theoretical Machine Learning. Hence you are encouraged to refer to standard Machine Learning references like *Pattern Recognition and Machine Learning*, Christopher Bishop, 2006, and *The Elements of Statistical Learning*, Robert Tibshirani et al., 2001, for more theoretical and mathematical details on the internals of Machine Learning algorithms and methods.

---

## Supervised Learning

Supervised learning methods or algorithms include learning algorithms that take in data samples (known as training data) and associated outputs (known as labels or responses) with each data sample during the model training process. The main objective is to learn a mapping or association between input data samples  $x$  and their corresponding outputs  $y$  based on multiple training data instances. This learned knowledge can then be used in the future to predict an output  $y'$  for any new input data sample  $x'$  which was previously unknown or unseen during the model training process. These methods are termed as supervised because the model learns on data samples where the desired output responses/labels are already known beforehand in the training phase.

Supervised learning basically tries to model the relationship between the inputs and their corresponding outputs from the training data so that we would be able to predict output responses for new data inputs based on the knowledge it gained earlier with regard to relationships and mappings between the inputs and their target outputs. This is precisely why supervised learning methods are extensively used in predictive analytics where the main objective is to predict some response for some input data that's typically fed into a trained supervised ML model. Supervised learning methods are of two major classes based on the type of ML tasks they aim to solve.



- Classification
- Regression

Let’s look at these two Machine Learning tasks and observe the subset of supervised learning methods that are best suited for tackling these tasks.

## Classification

The classification based tasks are a sub-field under supervised Machine Learning, where the key objective is to predict output labels or responses that are categorical in nature for input data based on what the model has learned in the training phase. Output labels here are also known as classes or class labels as these are categorical in nature meaning they are unordered and discrete values. Thus, each output response belongs to a specific discrete class or category.

Suppose we take a real-world example of predicting the weather. Let’s keep it simple and say we are trying to predict if the weather is sunny or rainy based on multiple input data samples consisting of attributes or features like humidity, temperature, pressure, and precipitation. Since the prediction can be either sunny or rainy, there are a total of two distinct classes in total; hence this problem can also be termed as a binary classification problem. Figure 1-15 depicts the binary weather classification task of predicting weather as either sunny or rainy based on training the supervised model on input data samples having feature vectors, (precipitation, humidity, pressure, and temperature) for each data sample/observation and their corresponding class labels as either sunny or rainy.

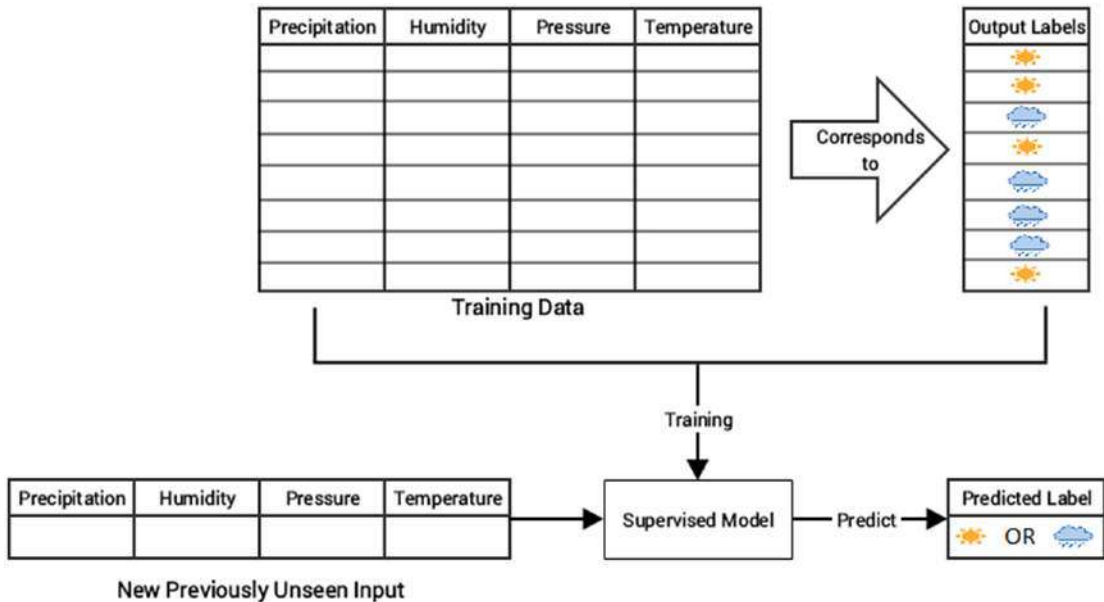

**Figure 1-15.** Supervised learning: binary classification for weather prediction

A task where the total number of distinct classes is more than two becomes a multi-class classification problem where each prediction response can be any one of the probable classes from this set. A simple example would be trying to predict numeric digits from scanned handwritten images. In this case it becomes a 10-class classification problem because the output class label for any image can be any digit from 0 - 9. In

both the cases, the output class is a scalar value pointing to one specific class. Multi-label classification tasks are such that based on any input data sample, the output response is usually a vector having one or more than one output class label. A simple real-world problem would be trying to predict the category of a news article that could have multiple output classes like news, finance, politics, and so on.

Popular classification algorithms include logistic regression, support vector machines, neural networks, ensembles like random forests and gradient boosting, K-nearest neighbors, decision trees, and many more.

## Regression

Machine Learning tasks where the main objective is value estimation can be termed as *regression* tasks. Regression based methods are trained on input data samples having output responses that are continuous numeric values unlike classification, where we have discrete categories or classes. Regression models make use of input data attributes or features (also called explanatory or independent variables) and their corresponding continuous numeric output values (also called as response, dependent, or outcome variable) to learn specific relationships and associations between the inputs and their corresponding outputs. With this knowledge, it can predict output responses for new, unseen data instances similar to classification but with continuous numeric outputs.

One of the most common real-world examples of regression is prediction of house prices. You can build a simple regression model to predict house prices based on data pertaining to land plot areas in square feet. Figure 1-16 shows two possible regression models based on different methods to predict house prices based on plot area.

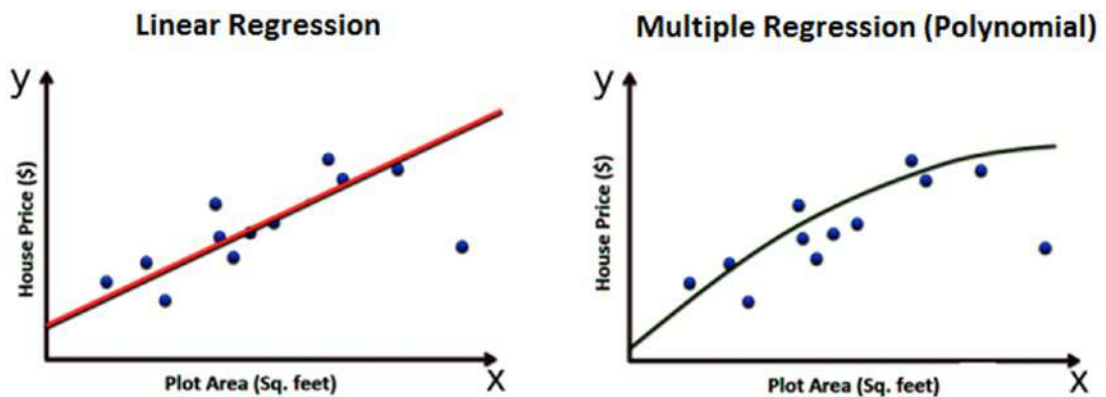

**Figure 1-16.** Supervised learning: regression models for house price prediction

The basic idea here is that we try to determine if there is any relationship or association between the data feature plot area and the outcome variable, which is the house price and is what we want to predict. Thus once we learn this trend or relationship depicted in Figure 1-16, we can predict house prices in the future for any given plot of land. If you have noticed the figure closely, we depicted two types of models on purpose to show that there can be multiple ways to build a model on your training data. The main objective is to minimize errors during training and validating the model so that it generalized well, does not overfit or get biased only to the training data and performs well in future predictions.

*Simple linear regression* models try to model relationships on data with one feature or explanatory variable  $x$  and a single response variable  $y$  where the objective is to predict  $y$ . Methods like ordinary least squares (OLS) are typically used to get the best linear fit during model training.

*Multiple regression* is also known as multivariable regression. These methods try to model data where we have one response output variable  $y$  in each observation but multiple explanatory variables in the form of a vector  $X$  instead of a single explanatory variable. The idea is to predict  $y$  based on the different features present in  $X$ . A real-world example would be extending our house prediction model to build a more sophisticated model where we predict the house price based on multiple features instead of just plot area in each data sample. The features could be represented in a vector as plot area, number of bedrooms, number of bathrooms, total floors, furnished, or unfurnished. Based on all these attributes, the model tries to learn the relationship between each feature vector and its corresponding house price so that it can predict them in the future.

*Polynomial regression* is a special case of multiple regression where the response variable  $y$  is modeled as an  $n$ th degree polynomial of the input feature  $x$ . Basically it is multiple regression, where each feature in the input feature vector is a multiple of  $x$ . The model on the right in Figure 1-16 to predict house prices is a polynomial model of degree 2.

*Non-linear regression* methods try to model relationships between input features and outputs based on a combination of non-linear functions applied on the input features and necessary model parameters.

*Lasso regression* is a special form of regression that performs normal regression and generalizes the model well by performing regularization as well as feature or variable selection. Lasso stands for least absolute shrinkage and selection operator. The L1 norm is typically used as the regularization term in lasso regression.

*Ridge regression* is another special form of regression that performs normal regression and generalizes the model by performing regularization to prevent overfitting the model. Typically the L2 norm is used as the regularization term in ridge regression.

*Generalized linear models* are generic frameworks that can be used to model data predicting different types of output responses, including continuous, discrete, and ordinal data. Algorithms like logistic regression are used for categorical data and ordered probit regression for ordinal data.

## Unsupervised Learning

Supervised learning methods usually require some training data where the outcomes which we are trying to predict are already available in the form of discrete labels or continuous values. However, often we do not have the liberty or advantage of having pre-labeled training data and we still want to extract useful insights or patterns from our data. In this scenario, unsupervised learning methods are extremely powerful. These methods are called unsupervised because the model or algorithm tries to learn inherent latent structures, patterns and relationships from given data without any help or supervision like providing annotations in the form of labeled outputs or outcomes.

Unsupervised learning is more concerned with trying to extract meaningful insights or information from data rather than trying to predict some outcome based on previously available supervised training data. There is more uncertainty in the results of unsupervised learning but you can also gain a lot of information from these models that was previously unavailable to view just by looking at the raw data. Often unsupervised learning could be one of the tasks involved in building a huge intelligence system. For example, we could use unsupervised learning to get possible outcome labels for tweet sentiments by using the knowledge of the English vocabulary and then train a supervised model on similar data points and their outcomes which we obtained previously through unsupervised learning. There is no hard and fast rule with regard to using just one specific technique. You can always combine multiple methods as long as they are relevant in solving the problem. Unsupervised learning methods can be categorized under the following broad areas of ML tasks relevant to unsupervised learning.

- Clustering
- Dimensionality reduction
- Anomaly detection
- Association rule-mining

We explore these tasks briefly in the following sections to get a good feel of how unsupervised learning methods are used in the real world.

## Clustering

Clustering methods are Machine Learning methods that try to find patterns of similarity and relationships among data samples in our dataset and then cluster these samples into various groups, such that each group or cluster of data samples has some similarity, based on the inherent attributes or features. These methods are completely unsupervised because they try to cluster data by looking at the data features without any prior training, supervision, or knowledge about data attributes, associations, and relationships.

Consider a real-world problem of running multiple servers in a data center and trying to analyze logs for typical issues or errors. Our main task is to determine the various kinds of log messages that usually occur frequently each week. In simple words, we want to group log messages into various clusters based on some inherent characteristics. A simple approach would be to extract features from the log messages, which would be in textual format and apply clustering on the same and group similar log messages together based on similarity in content. Figure 1-17 shows how clustering would solve this problem. Basically we have raw log messages to start with. Our clustering system would employ feature extraction to extract features from text like word occurrences, phrase occurrences, and so on. Finally, a clustering algorithm like K-means or hierarchical clustering would be employed to group or cluster messages based on similarity of their inherent features.

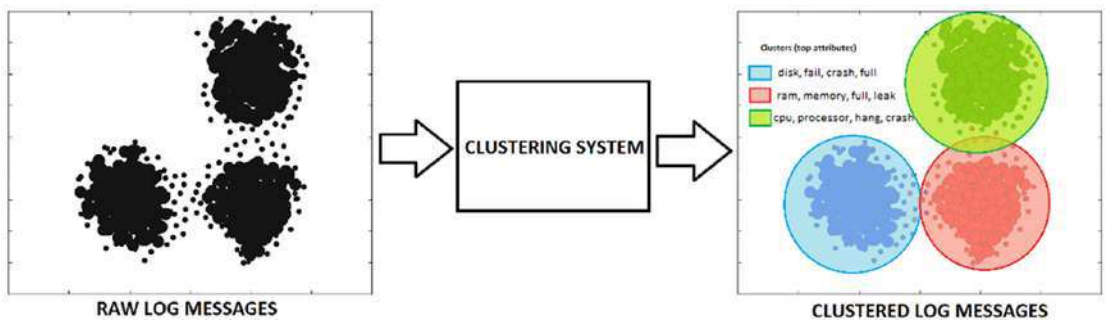

**Figure 1-17.** *Unsupervised learning: clustering log messages*

It is quite clear from Figure 1-17 that our systems have three distinct clusters of log messages where the first cluster depicts disk issues, the second cluster is about memory issues, and the third cluster is about processor issues. Top feature words that helped in distinguishing the clusters and grouping similar data samples (logs) together are also depicted in the figure. Of course, sometimes some features might be present across multiple data samples hence there can be slight overlap of clusters too since this is unsupervised learning. However, the main objective is always to create clusters such that elements of each cluster are near each other and far apart from elements of other clusters.

There are various types of clustering methods that can be classified under the following major approaches.

- Centroid based methods such as K-means and K-medoids
- Hierarchical clustering methods such as agglomerative and divisive (Ward's, affinity propagation)
- Distribution based clustering methods such as Gaussian mixture models
- Density based methods such as dbscan and optics.

Besides this, we have several methods that recently came into the clustering landscape, like `birch` and `clarans`.

## Dimensionality Reduction

Once we start extracting attributes or features from raw data samples, sometimes our feature space gets bloated up with a humongous number of features. This poses multiple challenges including analyzing and visualizing data with thousands or millions of features, which makes the feature space extremely complex posing problems with regard to training models, memory, and space constraints. In fact this is referred to as the “curse of dimensionality”. Unsupervised methods can also be used in these scenarios, where we reduce the number of features or attributes for each data sample. These methods reduce the number of feature variables by extracting or selecting a set of principal or representative features. There are multiple popular algorithms available for dimensionality reduction like Principal Component Analysis (PCA), nearest neighbors, and discriminant analysis. Figure 1-18 shows the output of a typical feature reduction process applied to a Swiss Roll 3D structure having three dimensions to obtain a two-dimensional feature space for each data sample using PCA.

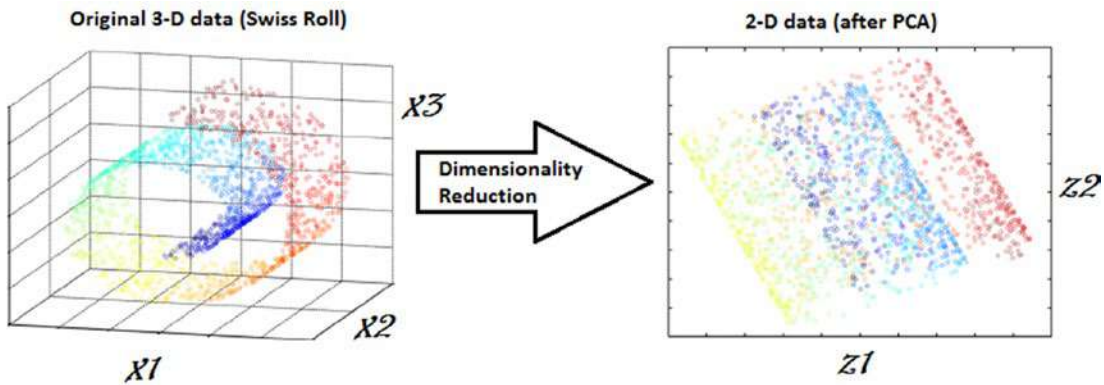

**Figure 1-18.** Unsupervised learning: dimensionality reduction

From Figure 1-18, it is quite clear that each data sample originally had three features or dimensions, namely  $D(x_1, x_2, x_3)$  and after applying PCA, we reduce each data sample from our dataset into two dimensions, namely  $D'(z_1, z_2)$ . Dimensionality reduction techniques can be classified in two major approaches as follows.

- **Feature Selection methods:** Specific features are selected for each data sample from the original list of features and other features are discarded. No new features are generated in this process.
- **Feature Extraction methods:** We engineer or extract new features from the original list of features in the data. Thus the reduced subset of features will contain newly generated features that were not part of the original feature set. PCA falls under this category.

## Anomaly Detection

The process of anomaly detection is also termed as outlier detection, where we are interested in finding out occurrences of rare events or observations that typically do not occur normally based on historical data samples. Sometimes anomalies occur infrequently and are thus rare events, and in other instances, anomalies might not be rare but might occur in very short bursts over time, thus have specific patterns. Unsupervised learning methods can be used for anomaly detection such that we train the algorithm on the training dataset having normal, non-anomalous data samples. Once it learns the necessary data representations, patterns, and relations among attributes in normal samples, for any new data sample, it would be able to identify it as anomalous or a normal data point by using its learned knowledge. Figure 1-19 depicts some typical anomaly detection based scenarios where you could apply supervised methods like one-class SVM and unsupervised methods like clustering, K-nearest neighbors, auto-encoders, and so on to detect anomalies based on data and its features.

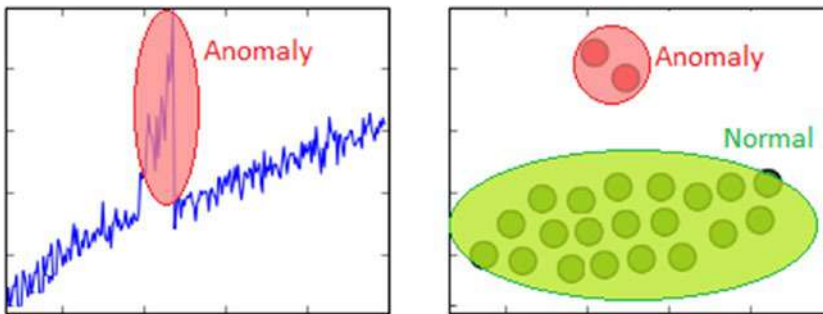
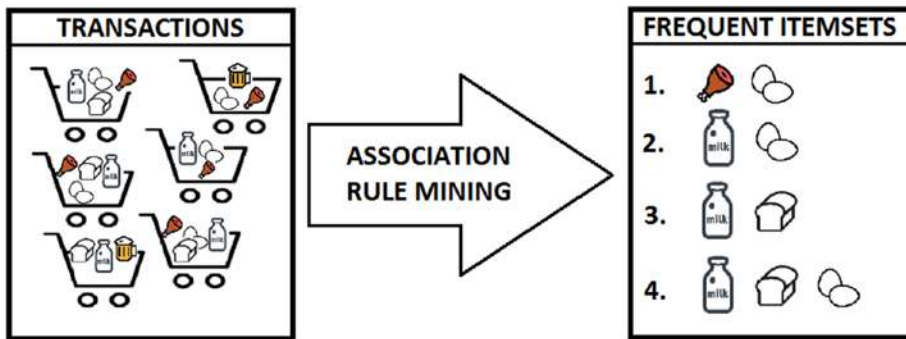

**Figure 1-19.** Unsupervised learning: anomaly detection

Anomaly detection based methods are extremely popular in real-world scenarios like detection of security attacks or breaches, credit card fraud, manufacturing anomalies, network issues, and many more.

## Association Rule-Mining

Typically association rule-mining is a data mining method used to examine and analyze large transactional datasets to find patterns and rules of interest. These patterns represent interesting relationships and associations, among various items across transactions. Association rule-mining is also often termed as *market basket analysis*, which is used to analyze customer shopping patterns. Association rules help in detecting and predicting transactional patterns based on the knowledge it gains from training transactions. Using this technique, we can answer questions like what items do people tend to buy together, thereby indicating frequent item sets. We can also associate or correlate products and items, i.e., insights like people who buy beer also tend to buy chicken wings at a pub. Figure 1-20 shows how a typical association rule-mining method should work ideally on a transactional dataset.



**Figure 1-20.** Unsupervised learning: association rule-mining

From Figure 1-20, you can clearly see that based on different customer transactions over a period of time, we have obtained the items that are closely associated and customers tend to buy them together. Some of these frequent item sets are depicted like  $\{meat, eggs\}$ ,  $\{milk, eggs\}$  and so on. The criterion of determining good quality association rules or frequent item sets is usually done using metrics like support, confidence, and lift.

This is an unsupervised method, because we have no idea what the frequent item sets are or which items are more strongly associated with which items beforehand. Only after applying algorithms like the apriori algorithm or FP-growth, can we detect and predict products or items associated closely with each other and find conditional probabilistic dependencies. We cover association rule-mining in further details in Chapter 8.

## Semi-Supervised Learning

The semi-supervised learning methods typically fall between supervised and unsupervised learning methods. These methods usually use a lot of training data that's unlabeled (forming the unsupervised learning component) and a small amount of pre-labeled and annotated data (forming the supervised learning component). Multiple techniques are available in the form of generative methods, graph based methods, and heuristic based methods.

A simple approach would be building a supervised model based on labeled data, which is limited, and then applying the same to large amounts of unlabeled data to get more labeled samples, train the model on them and repeat the process. Another approach would be to use unsupervised algorithms to cluster similar data samples, use human-in-the-loop efforts to manually annotate or label these groups, and then use a combination of this information in the future. This approach is used in many image tagging systems. Covering semi-supervised methods would be out of the present scope of this book.

## Reinforcement Learning

The reinforcement learning methods are a bit different from conventional supervised or unsupervised methods. In this context, we have an agent that we want to train over a period of time to interact with a specific environment and improve its performance over a period of time with regard to the type of actions it performs on the environment. Typically the agent starts with a set of strategies or policies for interacting with the environment. On observing the environment, it takes a particular action based on a rule or policy and by observing the current state of the environment. Based on the action, the agent gets a reward, which could be beneficial or detrimental in the form of a penalty. It updates its current policies and strategies if needed and

this iterative process continues till it learns enough about its environment to get the desired rewards. The main steps of a reinforcement learning method are mentioned as follows.

1. Prepare agent with set of initial policies and strategy
2. Observe environment and current state
3. Select optimal policy and perform action
4. Get corresponding reward (or penalty)
5. Update policies if needed
6. Repeat Steps 2 - 5 iteratively until agent learns the most optimal policies

Consider a real-world problem of trying to make a robot or a machine learn to play chess. In this case the agent would be the robot and the environment and states would be the chessboard and the positions of the chess pieces. A suitable reinforcement learning methodology is depicted in Figure 1-21.

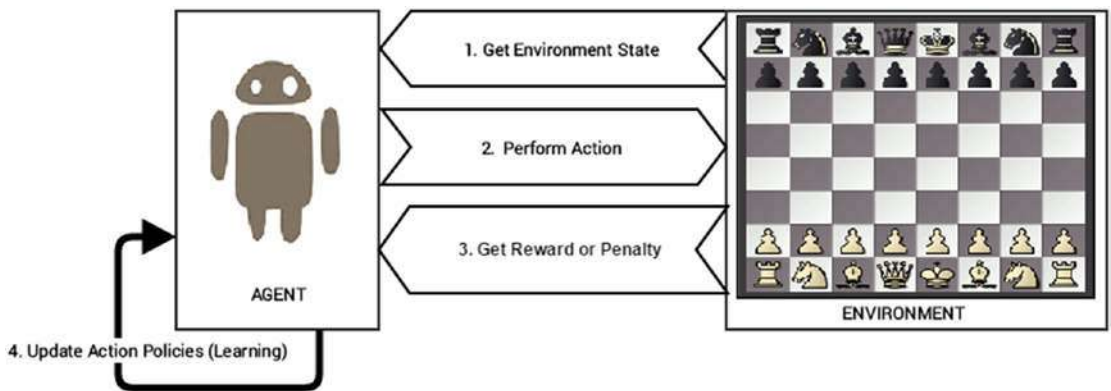

**Figure 1-21.** Reinforcement learning: training a robot to play chess

The main steps involved for making the robot learn to play chess is pictorially depicted in Figure 1-21. This is based on the steps discussed earlier for any reinforcement learning method. In fact, Google's DeepMind built the AlphaGo AI with components of reinforcement learning to train the system to play the game of Go.

## Batch Learning

Batch learning methods are also popularly known as offline learning methods. These are Machine Learning methods that are used in end-to-end Machine Learning systems where the model is trained using all the available training data in one go. Once training is done and the model completes the process of learning, on getting a satisfactory performance, it is deployed into production where it predicts outputs for new data samples. However, the model doesn't keep learning over a period of time continuously with the new data. Once the training is complete the model stops learning. Thus, since the model trains with data in one single batch and it is usually a one-time procedure, this is known as *batch* or *offline learning*.



We can always train the model on new data but then we would have to add new data samples along with the older historical training data and again re-build the model using this new batch of data. If most of the model building workflow has already been implemented, retraining a model would not involve a lot of effort; however, with the data size getting bigger with each new data sample, the retraining process will start consuming more processor, memory, and disk resources over a period of time. These are some points to be considered when you are building models that would be running from systems having limited capacity.

## Online Learning

Online learning methods work in a different way as compared to batch learning methods. The training data is usually fed in multiple incremental batches to the algorithm. These data batches are also known as mini-batches in ML terminology. However, the training process does not end there unlike batch learning methods. It keeps on learning over a period of time based on new data samples which are sent to it for prediction. Basically it predicts and learns in the process with new data on the fly without have to re-run the whole model on previous data samples.

There are several advantages to online learning—it is suitable in real-world scenarios where the model might need to keep learning and re-training on new data samples as they arrive. Problems like device failure or anomaly prediction and stock market forecasting are two relevant scenarios. Besides this, since the data is fed to the model in incremental mini-batches, you can build these models on commodity hardware without worrying about memory or disk constraints since unlike batch learning methods, you do not need to load the full dataset in memory before training the model. Besides this, once the model trains on datasets, you can remove them since we do not need the same data again as the model learns incrementally and remembers what it has learned in the past.

One of the major caveats in online learning methods is the fact that bad data samples can affect the model performance adversely. All ML methods work on the principle of “Garbage In Garbage Out”. Hence if you supply bad data samples to a well-trained model, it can start learning relationships and patterns that have no real significance and this ends up affecting the overall model performance. Since online learning methods keep learning based on new data samples, you should ensure proper checks are in place to notify you in case suddenly the model performance drops. Also suitable model parameters like learning rate should be selected with care to ensure the model doesn’t overfit or get biased based on specific data samples.

## Instance Based Learning

There are various ways to build Machine Learning models using methods that try to generalize based on input data. Instance based learning involves ML systems and methods that use the raw data points themselves to figure out outcomes for newer, previously unseen data samples instead of building an explicit model on training data and then testing it out.

A simple example would be a K-nearest neighbor algorithm. Assuming  $k = 3$ , we have our initial training data. The ML method knows the representation of the data from the features, including its dimensions, position of each data point, and so on. For any new data point, it will use a similarity measure (like cosine or Euclidean distance) and find the three nearest input data points to this new data point. Once that is decided, we simply take a majority of the outcomes for those three training points and predict or assign it as the outcome label/response for this new data point. Thus, instance based learning works by looking at the input data points and using a similarity metric to generalize and predict for new data points.

## Model Based Learning

The model based learning methods are a more traditional ML approach toward generalizing based on training data. Typically an iterative process takes place where the input data is used to extract features and models are built based on various model parameters (known as *hyperparameters*). These hyperparameters are optimized based on various model validation techniques to select the model that generalizes best on the training data and some amount of validation and test data (split from the initial dataset). Finally, the best model is used to make predictions or decisions as and when needed.

## The CRISP-DM Process Model

The CRISP-DM model stands for Cross Industry Standard Process for Data Mining. More popularly known by the acronym itself, CRISP-DM is a tried, tested, and robust industry standard process model followed for data mining and analytics projects. CRISP-DM clearly depicts necessary steps, processes, and workflows for executing any project right from formalizing business requirements to testing and deploying a solution to transform data into insights. Data Science, Data Mining, and Machine Learning are all about trying to run multiple iterative processes to extract insights and information from data. Hence we can say that analyzing data is truly both an art as well as a science, because it is not always about running algorithms without reason; a lot of the major effort involves in understanding the business, the actual value of the efforts being invested, and proper methods to articulate end results and insights.

The CRISP-DM model tells us that for building an end-to-end solution for any analytics project or system, there are a total of six major steps or phases, some of them being iterative. Just like we have a software development lifecycle with several major phases or steps for a software development project, we have a data mining or analysis lifecycle in this scenario. Figure 1-22 depicts the data mining lifecycle with the CRISP-DM model.

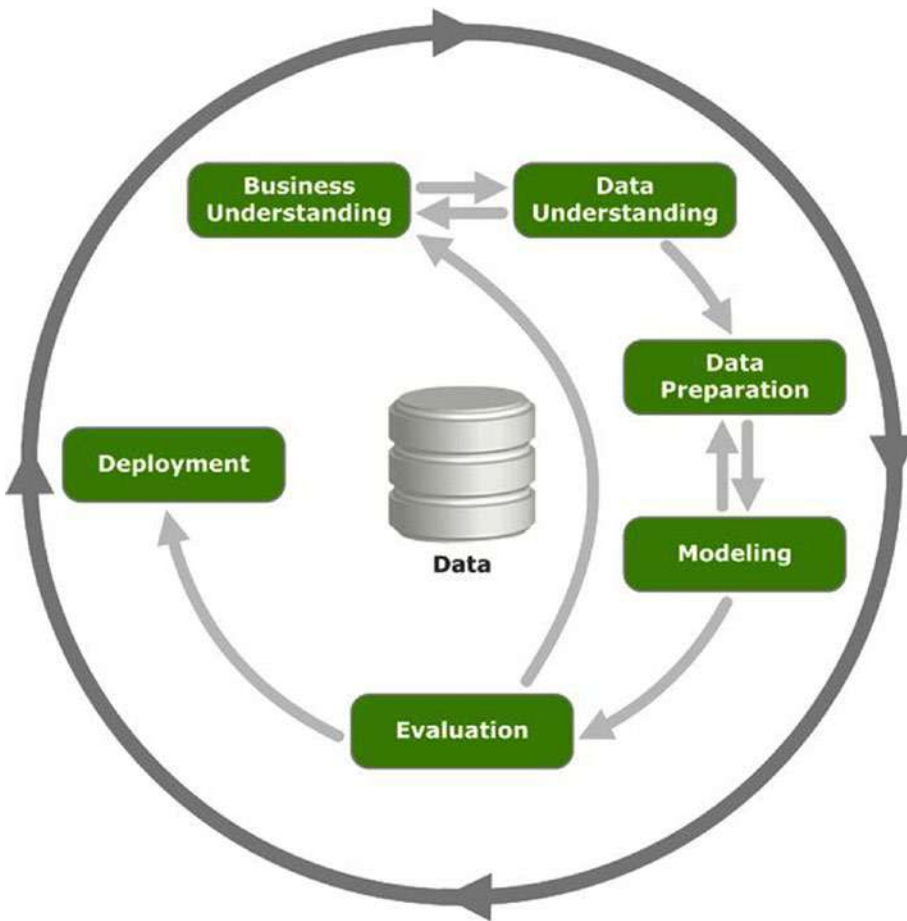

**Figure 1-22.** *The CRISP-DM model depicting the data mining lifecycle*

Figure 1-22 clearly shows there are a total of six major phases in the data mining lifecycle and the direction to proceed is depicted with arrows. This model is not a rigid imposition but rather a framework to ensure you are on the right track when going through the lifecycle of any analytics project. In some scenarios like anomaly detection or trend analysis, you might be more interested in data understanding, exploration, and visualization rather than intensive modeling. Each of the six phases is described in detail as follows.

## Business Understanding

This is the initial phase before kick starting any project in full flow. However this is one of the most important phases in the lifecycle! The main objective here starts with understanding the business context and requirements for the problem to be solved at hand. Definition of business requirements is crucial to convert the business problem into a data mining or analytics problem and to set expectations and success criteria for both the customer as well as the solution task force. The final deliverable from this phase would be a detailed plan with the major milestones of the project and expected timelines along with success criteria, assumptions, constraints, caveats, and challenges.

## Define Business Problem

The first task in this phase would be to start by understanding the business objective of the problem to be solved and build a formal definition of the problem. The following points are crucial toward clearly articulating and defining the business problem.

- Get business context of the problem to be solved, assess the problem with the help of domain, and subject matter experts (SMEs).
- Describe main pain points or target areas for business objective to be solved.
- Understand the solutions that are currently in place, what is lacking, and what needs to be improved.
- Define the business objective along with proper deliverables and success criteria based on inputs from business, data scientists, analysts, and SMEs.

## Assess and Analyze Scenarios

Once the business problem is defined clearly, the main tasks involved would be to analyze and assess the current scenario with regard to the business problem definition. This includes looking at what is currently available and making a note of various items required ranging from resources, personnel, to data. Besides this, proper assessment of risks and contingency plans need to be discussed. The main steps involved in the assessment stage here are mentioned as follows.

- Assess and analyze what is currently available to solve the problem from various perspectives including data, personnel, resource time, and risks.
- Build out a brief report of key resources needed (both hardware and software) and personnel involved. In case of any shortcomings, make sure to call them out as necessary.
- Discuss business objective requirements one by one and then identify and record possible assumptions and constraints for each requirement with the help of SMEs.
- Verify assumptions and constraints based on data available (a lot of this might be answered only after detailed analysis, hence it depends on the problem to be solved and the data available).
- Document and report possible risks involved in the project including timelines, resources, personnel, data, and financial based concerns. Build contingency plans for each possible scenario.
- Discuss success criteria and try to document a comparative return on investment or cost versus valuation analysis if needed. This just needs to be a rough benchmark to make sure the project aligns with the company or business vision.

## Define Data Mining Problem

This could be defined as the pre-analysis phase, which starts once the success criteria and the business problem is defined and all the risks, assumptions and constraints have been documented. This phase involves having detailed technical discussions with your analysts, data scientists, and developers and keeping the business stakeholders in sync. The following are the key tasks that are to be undertaken in this phase.

- Discuss and document possible Machine Learning and data mining methods suitable for the solution by assessing possible tools, algorithms, and techniques.
- Develop high-level designs for end-to-end solution architecture.
- Record notes on what the end output from the solution will be and how will it integrate with existing business components.
- Record success evaluation criteria from a Data Science standpoint. A simple example could be making sure that predictions are at least 80% accurate.

## Project Plan

This is the final stage under the business understanding phase. A project plan is generally created consisting of the entire major six phases in the CRISP-DM model, estimated timelines, allocated resources and personnel, and possible risks and contingency plans. Care is taken to ensure concrete high-level deliverables and success criteria are defined for each phase and iterative phases like modeling are highlighted with annotations like feedback based on SMEs might need models to be rebuilt and retuned before deployment.

You should be ready for the next step once you have the following points covered.

- Definition of business objectives for the problem
- Success criteria for business and data mining efforts
- Budget allocation and resource planning
- Clear, well-defined Machine Learning and data mining methodologies to be followed, including high-level workflows from exploration to deployment
- Detailed project plan with all six phases of the CRISP-DM model defined with estimated timelines and risks

## Data Understanding

The second phase in the CRISP-DM process involves taking a deep dive into the data available and understanding it in further detail before starting the process of analysis. This involves collecting the data, describing the various attributes, performing some exploratory analysis of the data, and keeping tabs on data quality. This phase should not be neglected because bad data or insufficient knowledge about available data can have cascading adverse effects in the later stages in this process.

## Data Collection

This task is undertaken to extract, curate, and collect all the necessary data needed for your business objective. Usually this involves making use of the organizations historical data warehouses, data marts, data lakes and so on. An assessment is done based on the existing data available in the organization and if there is any need for additional data. This can be obtained from the web, i.e., open data sources or it can be obtained from other channels like surveys, purchases, experiments and simulations. Detailed documents should keep

track of all datasets which would be used for analysis and additional data sources if any are necessary. This document can be combined with the subsequent stages of this phase.

## Data Description

Data description involves carrying out initial analysis on the data to understand more about the data, its source, volume, attributes, and relationships. Once these details are documented, any shortcomings if noted should be informed to relevant personnel. The following factors are crucial to building a proper data description document.

- Data sources (SQL, NoSQL, Big Data), record of origin (ROO), record of reference (ROR)
- Data volume (size, number of records, total databases, tables)
- Data attributes and their description (variables, data types)
- Relationship and mapping schemes (understand attribute representations)
- Basic descriptive statistics (mean, median, variance)
- Focus on which attributes are important for the business

## Exploratory Data Analysis

Exploratory data analysis, also known as EDA, is one of the first major analysis stages in the lifecycle. Here, the main objective is to explore and understand the data in detail. You can make use of descriptive statistics, plots, charts, and visualizations to look at the various data attributes, find associations and correlations and make a note of data quality problems if any. Following are some of the major tasks in this stage.

- Explore, describe, and visualize data attributes
- Select data and attributes subsets that seem most important for the problem
- Extensive analysis to find correlations and associations and test hypotheses
- Note missing data points if any

## Data Quality Analysis

Data quality analysis is the final stage in the data understanding phase where we analyze the quality of data in our datasets and document potential errors, shortcomings, and issues that need to be resolved before analyzing the data further or starting modeling efforts. The main focus on data quality analysis involves the following.

- Missing values
- Inconsistent values
- Wrong information due to data errors (manual/automated)
- Wrong metadata information

## Data Preparation

The third phase in the CRISP-DM process takes place after gaining enough knowledge on the business problem and relevant dataset. Data preparation is mainly a set of tasks that are performed to clean, wrangle, curate, and prepare the data before running any analytical or Machine Learning methods and building models. We will briefly discuss some of the major tasks under the data preparation phase in this section. An important point to remember here is that data preparation usually is the most time consuming phase in the data mining lifecycle and often takes 60% to 70% time in the overall project. However this phase should be taken very seriously because, like we have discussed multiple times before, bad data will lead to bad models and poor performance and results.

## Data Integration

The process of data integration is mainly done when we have multiple datasets that we might want to integrate or merge. This can be done in two ways. Appending several datasets by combining them, which is typically done for datasets having the same attributes. Merging several datasets together having different attributes or columns, by using common fields like keys.

## Data Wrangling

The process of data wrangling or data munging involves data processing, cleaning, normalization, and formatting. Data in its raw form is rarely consumable by Machine Learning methods to build models. Hence we need to process the data based on its form, clean underlying errors and inconsistencies, and format it into more consumable formats for ML algorithms. Following are the main tasks relevant to data wrangling.

- Handling missing values (remove rows, impute missing values)
- Handling data inconsistencies (delete rows, attributes, fix inconsistencies)
- Fixing incorrect metadata and annotations
- Handling ambiguous attribute values
- Curating and formatting data into necessary formats (CSV, Json, relational)

## Attribute Generation and Selection

Data is comprised of observations or samples (rows) and attributes or features (columns). The process of attribute generation is also known as feature extraction and engineering in Machine Learning terminology. Attribute generation is basically creating new attributes or variables from existing attributes based on some rules, logic, or hypothesis. A simple example would be creating a new numeric variable called age based on two date-time fields—`current_date` and `birth_date`—for a dataset of employees in an organization. There are several techniques with regard to attribute generation that we discuss in future chapters.

Attribute selection is basically selecting a subset of features or attributes from the dataset based on parameters like attribute importance, quality, relevancy, assumptions, and constraints. Sometimes even Machine Learning methods are used to select relevant attributes based on the data. This is popularly known as feature selection in Machine Learning terminology.

## Modeling

The fourth phase in the CRISP-DM process is the core phase in the process where most of the analysis takes place with regard to using clean, formatted data and its attributes to build models to solve business problems. This is an iterative process, as depicted in Figure 1-22 earlier, along with model evaluation and all the preceding steps leading up to modeling. The basic idea is to build multiple models iteratively trying to get to the best model that satisfies our success criteria, data mining objectives, and business objectives. We briefly talk about some of the major stages relevant to modeling in this section.

## Selecting Modeling Techniques

In this stage, we pick up a list of relevant Machine Learning and data mining tools, frameworks, techniques, and algorithms listed in the “Business Understanding” phase. Techniques that are proven to be robust and useful in solving the problem are usually selected based on inputs and insights from data analysts and data scientists. These are mainly decided by the current data available, business goals, data mining goals, algorithm requirements, and constraints.

## Model Building

The process of model building is also known as training the model using data and features from our dataset. A combination of data (features) and Machine Learning algorithms together give us a model that tries to generalize on the training data and give necessary results in the form of insights and/or predictions. Generally various algorithms are used to try out multiple modeling approaches on the same data to solve the same problem to get the best model that performs and gives outputs that are the closest to the business success criteria. Key things to keep track here are the models created, model parameters being used, and their results.

## Model Evaluation and Tuning

In this stage, we evaluate each model based on several metrics like model accuracy, precision, recall, F1 score, and so on. We also tune the model parameters based on techniques like grid search and cross validation to get to the model that gives us the best results. Tuned models are also matched with the data mining goals to see if we are able to get the desired results as well as performance. Model tuning is also termed as hyperparameter optimization in the Machine Learning world.

## Model Assessment

Once we have models that are providing desirable and relevant results, a detailed assessment of the model is performed based on the following parameters.

- Model performance is in line with defined success criteria
- Reproducible and consistent results from models
- Scalability, robustness, and ease of deployment
- Future extensibility of the model
- Model evaluation gives satisfactory results



## Evaluation

The fifth phase in the CRISP-DM process takes place once we have the final models from the modeling phase that satisfy necessary success criteria with respect to our data mining goals and have the desired performance and results with regard to model evaluation metrics like accuracy. The evaluation phase involves carrying out a detailed assessment and review of the final models and the results which are obtained from them. Some of the main points that are evaluated in this section are as follows.

- Ranking final models based on the quality of results and their relevancy based on alignment with business objectives
- Any assumptions or constraints that were invalidated by the models
- Cost of deployment of the entire Machine Learning pipeline from data extraction and processing to modeling and predictions
- Any pain points in the whole process? What should be recommended? What should be avoided?
- Data sufficiency report based on results
- Final suggestions, feedback, and recommendations from solutions team and SMEs

Based on the report formed from these points, after a discussion, the team can decide whether they want to proceed to the next phase of model deployment or a full reiteration is needed, starting from business and data understanding to modeling.

## Deployment

The final phase in the CRISP-DM process is all about deploying your selected models to production and making sure the transition from development to production is seamless. Usually most organizations follow a standard path-to-production methodology. A proper plan for deployment is built based on resources required, servers, hardware, software, and so on. Models are validated, saved, and deployed on necessary systems and servers. A plan is also put in place for regular monitoring and maintenance of models to continuously evaluate their performance, check for results and their validity, and retire, replace, and update models as and when needed.

## Building Machine Intelligence

The objective of Machine Learning, data mining, or artificial intelligence is to make our lives easier, automate tasks, and take better decisions. Building machine intelligence involves everything we have learned until now starting from Machine Learning concepts to actually implementing and building models and using them in the real world. Machine intelligence can be built using non-traditional computing approaches like Machine Learning. In this section, we establish full-fledged end-to-end Machine Learning pipelines based on the CRISP-DM model, which will help us solve real-world problems by building machine intelligence using a structured process.

## Machine Learning Pipelines

The best way to solve a real-world Machine Learning or analytics problem is to use a Machine Learning pipeline starting from getting your data to transforming it into information and insights using Machine

Learning algorithms and techniques. This is more of a technical or solution based pipeline and it assumes that several aspects of the CRISP-DM model are already covered, including the following points.

- Business and data understanding
- ML/DM technique selection
- Risk, assumptions, and constraints assessment

A Machine Learning pipeline will mainly consist of elements related to data retrieval and extraction, preparation, modeling, evaluation, and deployment. Figure 1-23 shows a high-level overview of a standard Machine Learning pipeline with the major phases highlighted in their blocks.

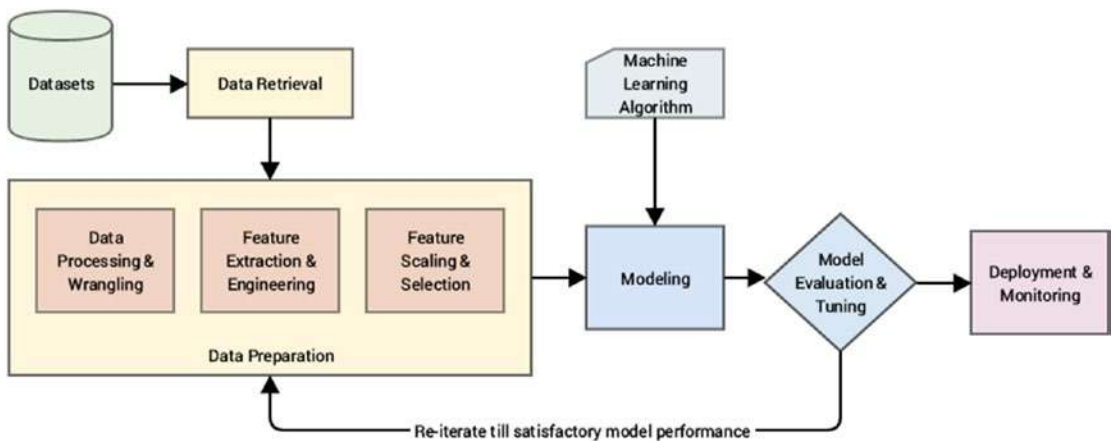

**Figure 1-23.** A standard Machine Learning pipeline

From Figure 1-23, it is evident that there are several major phases in the Machine Learning pipeline and they are quite similar to the CRISP-DM process model, which is why we talked about it in detail earlier. The major steps in the pipeline are briefly mentioned here.

- **Data retrieval:** This is mainly data collection, extraction, and acquisition from various data sources and data stores. We cover data retrieval mechanisms in detail in Chapter 3, “Processing, Wrangling, and Visualizing Data”.
- **Data preparation:** In this step, we pre-process the data, clean it, wrangle it, and manipulate it as needed. Initial exploratory data analysis is also carried out. Next steps involved extracting, engineering, and selecting features/attributes from the data.
  - **Data processing and wrangling:** Mainly concerned with data processing, cleaning, munging, wrangling and performing initial descriptive and exploratory data analysis. We cover this in further details with hands-on examples in Chapter 3, “Processing, Wrangling, and Visualizing Data”.
  - **Feature extraction and engineering:** Here, we extract important features or attributes from the raw data and even create or engineer new features from existing features. Details on various feature engineering techniques are covered in Chapter 4, “Feature Engineering and Selection”.

- Feature scaling and selection:** Data features often need to be normalized and scaled to prevent Machine Learning algorithms from getting biased. Besides this, often we need to select a subset of all available features based on feature importance and quality. This process is known as feature selection. Chapter 4, “Feature Engineering and Selection,” covers these aspects.
- Modeling:** In the process of modeling, we usually feed the data features to a Machine Learning method or algorithm and train the model, typically to optimize a specific cost function in most cases with the objective of reducing errors and generalizing the representations learned from the data. Chapter 5, “Building, Tuning, and Deploying Models,” covers the art and science behind building Machine Learning models.
- Model evaluation and tuning:** Built models are evaluated and tested on validation datasets and, based on metrics like accuracy, F1 score, and others, the model performance is evaluated. Models have various parameters that are tuned in a process called hyperparameter optimization to get models with the best and optimal results. Chapter 5, “Building, Tuning, and Deploying Models,” covers these aspects.
- Deployment and monitoring:** Selected models are deployed in production and are constantly monitored based on their predictions and results. Details on model deployment are covered in Chapter 5, “Building, Tuning and Deploying Models.”

## Supervised Machine Learning Pipeline

By now we know that supervised Machine Learning methods are all about working with supervised labeled data to train models and then predict outcomes for new data samples. Some processes like feature engineering, scaling, and selection should always remain constant so that the same features are used for training the model and the same features are extracted from new data samples to feed the model in the prediction phase. Based on our earlier generic Machine Learning pipeline, Figure 1-24 shows a standard supervised Machine Learning pipeline.

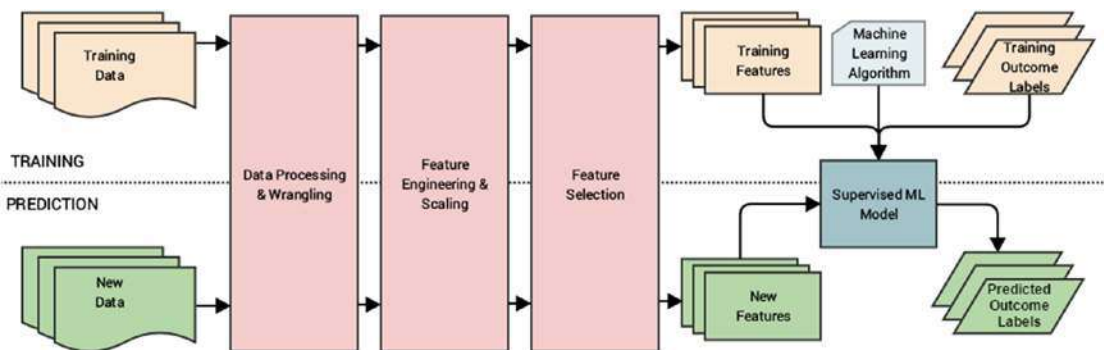

**Figure 1-24.** Supervised Machine Learning pipeline

You can clearly see the two phases of model training and prediction highlighted in Figure 1-24. Also, based on what we had mentioned earlier, the same sequence of data processing, wrangling, feature engineering, scaling, and selection is used for both data used in training the model and future data samples for which the model predicts outcomes. This is a very important point that you must remember whenever you are building any supervised model. Besides this, as depicted, the model is a combination of a Machine

Learning (supervised) algorithm and training data features and corresponding labels. This model will take features from new data samples and output predicted labels in the prediction phase.

## Unsupervised Machine Learning Pipeline

Unsupervised Machine Learning is all about extracting patterns, relationships, associations, and clusters from data. The processes related to feature engineering, scaling and selection are similar to supervised learning. However there is no concept of pre-labeled data here. Hence the unsupervised Machine Learning pipeline would be slightly different in contrast to the supervised pipeline. Figure 1-25 depicts a standard unsupervised Machine Learning pipeline.

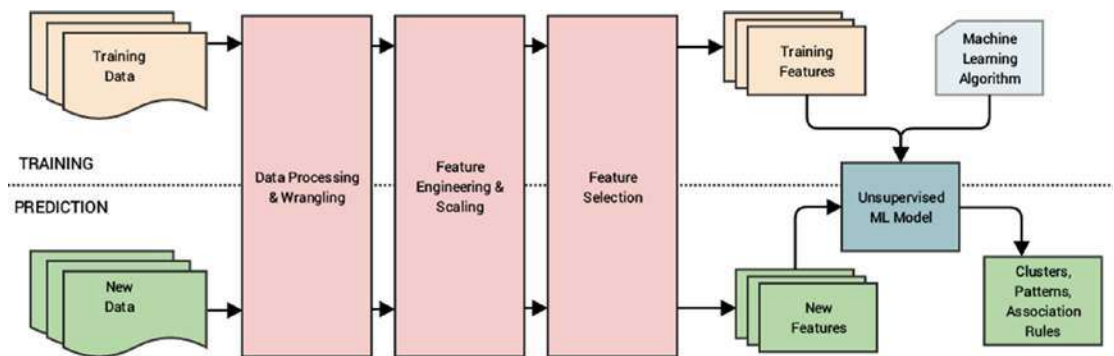

**Figure 1-25.** *Unsupervised Machine Learning pipeline*

Figure 1-25 clearly depicts that no supervised labeled data is used for training the model. With the absence of labels, we just have training data that goes through the same data preparation phase as in the supervised learning pipeline and we build our unsupervised model with an unsupervised Machine Learning algorithm and training features. In the prediction phase, we extract features from new data samples and pass them through the model which gives relevant results according to the type of Machine Learning task we are trying to perform, which can be clustering, pattern detection, association rules, or dimensionality reduction.

## Real-World Case Study: Predicting Student Grant Recommendations

Let's take a step back from what we have learned so far! The main objective here was to gain a solid grasp over the entire Machine Learning landscape, understand crucial concepts, build on the basic foundations, and understand how to execute Machine Learning projects with the help of Machine Learning pipelines with the CRISP-DM process model being the source of all inspiration. Let's put all this together to take a very basic real-world case study by building a supervised Machine Learning pipeline on a toy dataset. Our major objective is as follows. Given that you have several students with multiple attributes like grades, performance, and scores, can you build a model based on past historical data to predict the chance of the student getting a recommendation grant for a research project?

This will be a quick walkthrough with the main intent of depicting how to build and deploy a real-world Machine Learning pipeline and perform predictions. This will also give you a good hands-on experience to get started with Machine Learning. Do not worry too much if you don't understand the details of each and every line of code; the subsequent chapters cover all the tools, techniques, and frameworks used here in

detail. We will be using Python 3.5 in this book; you can refer to Chapter 2, “The Python Machine Learning Ecosystem” to understand more about Python and the various tools and frameworks used in Machine Learning. You can follow along with the code snippets in this section or open the Predicting Student Recommendation Machine Learning Pipeline.ipynb jupyter notebook by running **jupyter notebook** in the command line/terminal in the same directory as this notebook. You can then run the relevant code snippets in the notebook from your browser. Chapter 2 covers jupyter notebooks in detail.

## Objective

You have historical student performance data and their grant recommendation outcomes in the form of a comma separated value file named `student_records.csv`. Each data sample consists of the following attributes.

- Name (the student name)
- OverallGrade (overall grade obtained)
- Obedient (whether they were diligent during their course of stay)
- ResearchScore (marks obtained in their research work)
- ProjectScore (marks obtained in the project)
- Recommend (whether they got the grant recommendation)

Your main objective is to build a predictive model based on this data such that you can predict for any future student whether they will be recommended for the grant based on their performance attributes.

## Data Retrieval

Here, we will leverage the pandas framework to retrieve the data from the CSV file. The following snippet shows us how to retrieve the data and view it.

```
In [1]: import pandas as pd
...: # turn off warning messages
...: pd.options.mode.chained_assignment = None # default='warn'
...:
...: # get data
...: df = pd.read_csv('student_records.csv')
...: df
```

Out[1]:

	Name	OverallGrade	Obedient	ResearchScore	ProjectScore	Recommend
0	Henry	A	Y	90	85	Yes
1	John	C	N	85	51	Yes
2	David	F	N	10	17	No
3	Holmes	B	Y	75	71	No
4	Marvin	E	N	20	30	No
5	Simon	A	Y	92	79	Yes
6	Robert	B	Y	60	59	No
7	Trent	C	Y	75	33	No

**Figure 1-26.** Raw data depicting student records and their recommendations

Now that we can see data samples showing records for each student and their corresponding recommendation outcomes in Figure 1-26, we will perform necessary tasks relevant to data preparation.

## Data Preparation

Based on the dataset we saw earlier, we do not have any data errors or missing values, hence we will mainly focus on feature engineering and scaling in this section.

## Feature Extraction and Engineering

Let's start by extracting the existing features from the dataset and the outcomes in separate variables. The following snippet shows this process. See Figures 1-27 and 1-28.

```
In [2]: # get features and corresponding outcomes
...: feature_names = ['OverallGrade', 'Obedient', 'ResearchScore',
...:                  'ProjectScore']
...: training_features = df[feature_names]
...:
...: outcome_name = ['Recommend']
...: outcome_labels = df[outcome_name]

In [3]: # view features
...: training_features
```

Out[3]:

	<b>OverallGrade</b>	<b>Obedient</b>	<b>ResearchScore</b>	<b>ProjectScore</b>
<b>0</b>	A	Y	90	85
<b>1</b>	C	N	85	51
<b>2</b>	F	N	10	17
<b>3</b>	B	Y	75	71
<b>4</b>	E	N	20	30
<b>5</b>	A	Y	92	79
<b>6</b>	B	Y	60	59
<b>7</b>	C	Y	75	33

Figure 1-27. Dataset features

In [4]: # view outcome labels  
 ...: outcome\_labels

Out[4]:

	<b>Recommend</b>
<b>0</b>	Yes
<b>1</b>	Yes
<b>2</b>	No
<b>3</b>	No
<b>4</b>	No
<b>5</b>	Yes
<b>6</b>	No
<b>7</b>	No

Figure 1-28. Dataset recommendation outcome labels for each student

Now that we have extracted our initial available features from the data and their corresponding outcome labels, let's separate out our available features based on their type (numerical and categorical). Types of feature variables are covered in more detail in Chapter 3, "Processing, Wrangling, and Visualizing Data".

```
In [5]: # list down features based on type
...: numeric_feature_names = ['ResearchScore', 'ProjectScore']
...: categorical_feature_names = ['OverallGrade', 'Obedient']
```

We will now use a standard scalar from `scikit-learn` to scale or normalize our two numeric score-based attributes using the following code.

```
In [6]: from sklearn.preprocessing import StandardScaler
...: ss = StandardScaler()
...:
...: # fit scaler on numeric features
...: ss.fit(training_features[numeric_feature_names])
...:
...: # scale numeric features now
...: training_features[numeric_feature_names] =
...:     ss.transform(training_features[numeric_feature_names])
...:
...: # view updated featureset
...: training_features
```

Out[6]:

	<b>OverallGrade</b>	<b>Obedient</b>	<b>ResearchScore</b>	<b>ProjectScore</b>
<b>0</b>	A	Y	0.899583	1.376650
<b>1</b>	C	N	0.730648	-0.091777
<b>2</b>	F	N	-1.803390	-1.560203
<b>3</b>	B	Y	0.392776	0.772004
<b>4</b>	E	N	-1.465519	-0.998746
<b>5</b>	A	Y	0.967158	1.117516
<b>6</b>	B	Y	-0.114032	0.253735
<b>7</b>	C	Y	0.392776	-0.869179

**Figure 1-29.** Feature set with scaled numeric attributes



Now that we have successfully scaled our numeric features (see Figure 1-29), let's handle our categorical features and carry out the necessary feature engineering needed based on the following code.

```
In [7]: training_features = pd.get_dummies(training_features,
...:                                     columns=categorical_feature_names)
...: # view newly engineering features
...: training_features
```

Out[7]:

	ResearchScore	ProjectScore	OverallGrade_A	OverallGrade_B	OverallGrade_C	OverallGrade_E	OverallGrade_F	Obedient_N	Obedient_Y
0	0.899583	1.376650	1	0	0	0	0	0	1
1	0.730648	-0.091777	0	0	1	0	0	1	0
2	-1.803390	-1.560203	0	0	0	0	1	1	0
3	0.392776	0.772004	0	1	0	0	0	0	1
4	-1.465519	-0.998746	0	0	0	1	0	1	0
5	0.967158	1.117516	1	0	0	0	0	0	1
6	-0.114032	0.253735	0	1	0	0	0	0	1
7	0.392776	-0.869179	0	0	1	0	0	0	1

**Figure 1-30.** Feature set with engineered categorical variables

```
In [8]: # get list of new categorical features
...: categorical_engineered_features = list(set(training_features.columns) -
...:                                       set(numeric_feature_names))
```

Figure 1-30 shows us the updated feature set with the newly engineered categorical variables. This process is also known as one hot encoding.

## Modeling

We will now build a simple classification (supervised) model based on our feature set by using the logistic regression algorithm. The following code depicts how to build the supervised model.

```
In [9]: from sklearn.linear_model import LogisticRegression
...: import numpy as np
...:
...: # fit the model
...: lr = LogisticRegression()
...: model = lr.fit(training_features,
...:               np.array(outcome_labels['Recommend']))
...: # view model parameters
...: model
Out[9]: LogisticRegression(C=1.0, class_weight=None, dual=False,
...:                       fit_intercept=True, intercept_scaling=1, max_iter=100,
...:                       multi_class='ovr', n_jobs=1, penalty='l2',
...:                       random_state=None, solver='liblinear', tol=0.0001,
...:                       verbose=0, warm_start=False)
```

Thus, we now have our supervised learning model based on the logistic regression model with L2 regularization, as you can see from the parameters in the previous output.

## Model Evaluation

Typically model evaluation is done based on some holdout or validation dataset that is different from the training dataset to prevent overfitting or biasing the model. Since this is an example on a toy dataset, let's evaluate the performance of our model on the training data using the following snippet.

```
In [10]: # simple evaluation on training data
...: pred_labels = model.predict(training_features)
...: actual_labels = np.array(outcome_labels['Recommend'])
...:
...: # evaluate model performance
...: from sklearn.metrics import accuracy_score
...: from sklearn.metrics import classification_report
...:
...: print('Accuracy:', float(accuracy_score(actual_labels,
...:     pred_labels))*100, '%')
...: print('Classification Stats:')
...: print(classification_report(actual_labels, pred_labels))
```

Accuracy: 100.0 %

Classification Stats:

	precision	recall	f1-score	support
No	1.00	1.00	1.00	5
Yes	1.00	1.00	1.00	3
avg / total	1.00	1.00	1.00	8

Thus you can see the various metrics that we had mentioned earlier, like accuracy, precision, recall, and F1 score depicting the model performance. We talk about these metrics in detail in Chapter 5, “Building, Tuning, and Deploying Models”.

## Model Deployment

We built our first supervised learning model, and to deploy this model typically in a system or server, we need to persist the model. We also need to save the scalar object we used to scale the numerical features since we use it to transform the numeric features of new data samples. The following snippet depicts a way to store the model and scalar objects.

```
In [11]: from sklearn.externals import joblib
...: import os
...: # save models to be deployed on your server
...: if not os.path.exists('Model'):
...:     os.mkdir('Model')
...: if not os.path.exists('Scaler'):
...:     os.mkdir('Scaler')
...:
...: joblib.dump(model, r'Model/model.pickle')
...: joblib.dump(ss, r'Scaler/scaler.pickle')
```

These files can be easily deployed on a server with necessary code to reload the model and predict new data samples, which we will see in the upcoming sections.

## Prediction in Action

We are now ready to start predicting with our newly built and deployed model! To start predictions, we need to load our model and scaler objects into memory. The following code helps us do this.

```
In [12]: # load model and scaler objects
...: model = joblib.load(r'Model/model.pickle')
...: scaler = joblib.load(r'Scaler/scaler.pickle')
```

We have some sample new student records (for two students) for which we want our model to predict if they will get the grant recommendation. Let's retrieve and view this data using the following code.

```
In [13]: ## data retrieval
...: new_data = pd.DataFrame([{'Name': 'Nathan', 'OverallGrade': 'F',
...:                          'Obedient': 'N', 'ResearchScore': 30, 'ProjectScore': 20},
...:                          {'Name': 'Thomas', 'OverallGrade': 'A',
...:                          'Obedient': 'Y', 'ResearchScore': 78, 'ProjectScore': 80}])
...: new_data = new_data[['Name', 'OverallGrade', 'Obedient',
...:                      'ResearchScore', 'ProjectScore']]
...: new_data
```

Out[13]:

	Name	OverallGrade	Obedient	ResearchScore	ProjectScore
0	Nathan	F	N	30	20
1	Thomas	A	Y	78	80

**Figure 1-31.** New student records

We will now carry out the tasks relevant to data preparation—feature extraction, engineering, and scaling—in the following code snippet.

```
In [14]: ## data preparation
...: prediction_features = new_data[feature_names]
...:
...: # scaling
...: prediction_features[numeric_feature_names] =
...:     scaler.transform(prediction_features[numeric_feature_names])
...:
...: # engineering categorical variables
...: prediction_features = pd.get_dummies(prediction_features,
...:                                     columns=categorical_feature_names)
...:
...: # view feature set
...: prediction_features
```

Out[14]:

	ResearchScore	ProjectScore	OverallGrade_A	OverallGrade_F	Obedient_N	Obedient_Y
0	-1.127647	-1.430636	0	1	1	0
1	0.494137	1.160705	1	0	0	1

**Figure 1-32.** Updated feature set for new students

We now have the relevant features for the new students! However you can see that some of the categorical features are missing based on some grades like B, C, and E. This is because none of these students obtained those grades but we still need those attributes because the model was trained on all attributes including these. The following snippet helps us identify and add the missing categorical features. We add the value for each of those features as 0 for each student since they did not obtain those grades.

```
In [15]: # add missing categorical feature columns
...: current_categorical_engineered_features =
...:     set(prediction_features.columns) - set(numeric_feature_names)
...: missing_features = set(categorical_engineered_features) -
...:     current_categorical_engineered_features
...: for feature in missing_features:
...:     # add zeros since feature is absent in these data samples
...:     prediction_features[feature] = [0] * len(prediction_features)
...:
...: # view final feature set
...: prediction_features
```

Out[15]:

	ResearchScore	ProjectScore	OverallGrade_A	OverallGrade_F	Obedient_N	Obedient_Y	OverallGrade_C	OverallGrade_B	OverallGrade_E
0	-1.127647	-1.430636	0	1	1	0	0	0	0
1	0.494137	1.160705	1	0	0	1	0	0	0

**Figure 1-33.** Final feature set for new students

We have our complete feature set ready for both the new students. Let's put our model to the test and get the predictions with regard to grant recommendations!

```
In [16]: ## predict using model
...: predictions = model.predict(prediction_features)
...:
...: ## display results
...: new_data['Recommend'] = predictions
...: new_data
```

Out[16]:

	Name	OverallGrade	Obedient	ResearchScore	ProjectScore	Recommend
0	Nathan	F	N	30	20	No
1	Thomas	A	Y	78	80	Yes

**Figure 1-34.** New student records with model predictions for grant recommendations

We can clearly see from Figure 1-34 that our model has predicted grant recommendation labels for both the new students. Thomas clearly being diligent, having a straight A average and decent scores, is most likely to get the grant recommendation as compared to Nathan. Thus you can see that our model has learned how to predict grant recommendation outcomes based on past historical student data. This should whet your appetite on getting started with Machine Learning. We are about to deep dive into more complex real-world problems in the upcoming chapters!

## Challenges in Machine Learning

Machine Learning is a rapidly evolving, fast-paced, and exciting field with a lot of prospect, opportunity, and scope. However it comes with its own set of challenges, due to the complex nature of Machine Learning methods, its dependency on data, and not being one of the more traditional computing paradigms. The following points cover some of the main challenges in Machine Learning.

- Data quality issues lead to problems, especially with regard to data processing and feature extraction.
- Data acquisition, extraction, and retrieval is an extremely tedious and time consuming process.
- Lack of good quality and sufficient training data in many scenarios.
- Formulating business problems clearly with well-defined goals and objectives.
- Feature extraction and engineering, especially hand-crafting features, is one of the most difficult yet important tasks in Machine Learning. Deep Learning seems to have gained some advantage in this area recently.
- Overfitting or underfitting models can lead to the model learning poor representations and relationships from the training data leading to detrimental performance.
- The curse of dimensionality: too many features can be a real hindrance.
- Complex models can be difficult to deploy in the real world.

This is not an exhaustive list of challenges faced in Machine Learning today, but it is definitely a list of the top problems data scientists or analysts usually face in Machine Learning projects and tasks. We will cover dealing with these issues in detail when we discuss more about the various stages in the Machine Learning pipeline as well as solve real-world problems in subsequent chapters.

## Real-World Applications of Machine Learning

Machine Learning is widely being applied and used in the real world today to solve complex problems that would otherwise have been impossible to solve based on traditional approaches and rule-based systems. The following list depicts some of the real-world applications of Machine Learning.

- Product recommendations in online shopping platforms
- Sentiment and emotion analysis
- Anomaly detection
- Fraud detection and prevention
- Content recommendation (news, music, movies, and so on)
- Weather forecasting
- Stock market forecasting
- Market basket analysis
- Customer segmentation
- Object and scene recognition in images and video
- Speech recognition
- Churn analytics
- Click through predictions
- Failure/defect detection and prevention
- E-mail spam filtering

## Summary

The intent of this chapter was to get you familiarized with the foundations of Machine Learning before taking a deep dive into Machine Learning pipelines and solving real-world problems. The need for Machine Learning in today's world is introduced in the chapter with a focus on making data-driven decisions at scale. We also talked about the various programming paradigms and how Machine Learning has disrupted the traditional programming paradigm. Next up, we explored the Machine Learning landscape starting from the formal definition to the various domains and fields associated with Machine Learning. Basic foundational concepts were covered in areas like mathematics, statistics, computer science, Data Science, data mining, artificial intelligence, natural language processing, and Deep Learning since all of them tie back to Machine Learning and we will also be using tools, techniques, methodologies, and processes from these fields in future chapters. Concepts relevant to the various Machine Learning methods have also been covered including supervised, unsupervised, semi-supervised, and reinforcement learning. Other classifications of Machine Learning methods were depicted, like batch versus online based learning methods and online versus instance based learning methods. A detailed depiction of the CRISP-DM process model was explained to give an overview of the industry standard process for data mining projects. Analogies were drawn from this model to build Machine Learning pipelines, where we focus on both supervised and unsupervised learning pipelines.

We brought everything covered in this chapter together in solving a small real-world problem of predicting grant recommendations for students and building a sample Machine Learning pipeline from scratch. This should definitely get you ready for the next chapters, where you will be exploring each of the stages in a Machine Learning pipeline in further details and cover ground on the Python Machine Learning ecosystem. Last but not the least, challenges, and real-world applications of Machine Learning will give you a good idea on the vast scope of Machine Learning and make you aware of the caveats and pitfalls associated with Machine Learning problems.

## CHAPTER 2



# The Python Machine Learning Ecosystem

In the first chapter we explored the absolute basics of Machine Learning and looked at some of the algorithms that we can use. Machine Learning is a very popular and relevant topic in the world of technology today. Hence we have a very diverse and varied support for Machine Learning in terms of programming languages and frameworks. There are Machine Learning libraries for almost all popular languages including C++, R, Julia, Scala, Python, etc. In this chapter we try to justify why Python is an apt language for Machine Learning. Once we have argued our selection logically, we give you a brief introduction to the Python Machine Learning (ML) ecosystem. This Python ML ecosystem is a collection of libraries that enable the developers to extract and transform data, perform data wrangling operations, apply existing robust Machine Learning algorithms and also develop custom algorithms easily. These libraries include `numpy`, `scipy`, `pandas`, `scikit-learn`, `statsmodels`, `tensorflow`, `keras`, and so on. We cover several of these libraries in a nutshell so that the user will have some familiarity with the basics of each of these libraries. These will be used extensively in the later chapters of the book. An important thing to keep in mind here is that the purpose of this chapter is to acquaint you with the diverse set of frameworks and libraries in the Python ML ecosystem to get an idea of what can be leveraged to solve Machine Learning problems. We enrich the content with useful links that you can refer to for extensive documentation and tutorials. We assume some basic proficiency with Python and programming in general. All the code snippets and examples used in this chapter is available in the GitHub repository for this book at <https://github.com/dipanjanS/practical-machine-learning-with-python> under the directory/folder for Chapter 2. You can refer to the Python file named `python_ml_ecosystem.py` for all the examples used in this chapter and try the examples as you read this chapter or you can even refer to the jupyter notebook named The Python Machine Learning Ecosystem. `ipynb` for a more interactive experience.

## Python: An Introduction

Python was created by Guido van Rossum at Stichting Mathematisch Centrum (CWI, see <https://www.cwi.nl/>) in the Netherlands. The first version of Python was released in 1991. Guido wrote Python as a successor of the language called ABC. In the following years Python has developed into an extensively used high level language and a general programming language. Python is an interpreted language, which means that the source code of a Python program is converted into *bytecode*, which is then executed by the Python virtual machine. Python is

different from major compiled languages like C and C++ as Python code is not required to be *built* and *linked* like code for these languages. This distinction makes for two important points:

- **Python code is fast to develop:** As the code is not required to be compiled and built, Python code can be much readily changed and executed. This makes for a fast development cycle.
- **Python code is not as fast in execution:** Since the code is not directly compiled and executed and an additional layer of the Python virtual machine is responsible for execution, Python code runs a little slow as compared to conventional languages like C, C++, etc.

## Strengths

Python has steadily risen in the charts of widely used programming languages and according to several surveys and research; it is the fifth most important language in the world. Recently several surveys depicted Python to be the most popular language for Machine Learning and Data Science! We will compile a brief list of advantages that Python offers that probably explains its popularity.

1. **Easy to learn:** Python is a relatively easy-to-learn language. Its syntax is simple for a beginner to learn and understand. When compared with languages like C or Java, there is minimal boilerplate code required in executing a Python program.
2. **Supports multiple programming paradigms:** Python is a multi-paradigm, multi-purpose programming language. It supports object oriented programming, structured programming, functional programming, and even aspect oriented programming. This versatility allows it to be used by a multitude of programmers.
3. **Extensible:** Extensibility of Python is one of its most important characteristics. Python has a huge number of modules easily available which can be readily installed and used. These modules cover every aspect of programming from data access to implementation of popular algorithms. This easy-to-extend feature ensures that a Python developer is more productive as a large array of problems can be solved by available libraries.
4. **Active open source community:** Python is open source and supported by a large developer community. This makes it robust and adaptive. The bugs encountered are easily fixed by the Python community. Being open source, developers can tinker with the Python source code if their requirements call for it.

## Pitfalls

Although Python is a very popular programming language, it comes with its own share of pitfalls. One of the most important limitations it suffers is in terms of execution speed. Being an interpreted language, it is slow when compared to compiled languages. This limitation can be a bit restrictive in scenarios where extremely high performance code is required. This is a major area of improvement for future implementations of Python and every subsequent Python version addresses it. Although we have to admit it can never be as fast as a compiled language, we are convinced that it makes up for this deficiency by being super-efficient and effective in other departments.



## Setting Up a Python Environment

The starting step for our journey into the world of Data Science is the setup of our Python environment. We usually have two options for setting up our environment:

- Install Python and the necessary libraries individually
- Use a pre-packaged Python distribution that comes with necessary libraries, i.e. Anaconda

Anaconda is a packaged compilation of Python along with a whole suite of a variety of libraries, including core libraries which are widely used in Data Science. Developed by Anaconda, formerly known as Continuum Analytics, it is often the go-to setup for data scientists. Travis Oliphant, primary contributor to both the `numpy` and `scipy` libraries, is Anaconda's president and one of the co-founders. The Anaconda distribution is BSD licensed and hence it allows us to use it for commercial and redistribution purposes. A major advantage of this distribution is that we don't require an elaborate setup and it works well on all flavors of operating systems and platforms, especially Windows, which can often cause problems with installing specific Python packages. Thus, we can get started with our Data Science journey with just one download and install. The Anaconda distribution is widely used across industry Data Science environments and it also comes with a wonderful IDE, Spyder (Scientific Python Development Environment), besides other useful utilities like jupyter notebooks, the IPython console, and the excellent package management tool, `conda`. Recently they have also talked extensively about Jupyterlab, the next generation UI for Project Jupyter. We recommend using the Anaconda distribution and also checking out <https://www.anaconda.com/what-is-anaconda/> to learn more about Anaconda.

## Set Up Anaconda Python Environment

The first step in setting up your environment with the required Anaconda distribution is downloading the required installation package from <https://www.anaconda.com/download/>, which is the provider of the Anaconda distribution. The important point to note here is that we will be using Python 3.5 and the corresponding Anaconda distribution. Python 3.5.2 was released on June 2016 compared to 3.6, which released on December 2016. We have opted for 3.5 as we want to ensure that none of the libraries that we will be using in this book have any compatibility issues. Hence, as Python 3.5 has been around for a long time we avoid any such compatibility issues by opting for it. However, you are free to use Python 3.6 and the code used in this book is expected to work without major issues. We chose to leave out Python 2.7 since support for Python 2 will be ending in 2020 and from the Python community vision, it is clear that Python 3 is the future and we recommend you use *it*.

Download the Anaconda3-4.2.0-Windows-x86\_64 package (the one with Python 3.5) from <https://repo.continuum.io/archive/>. A screenshot of the target page is shown in Figure 2-1. We have chosen the Windows OS specifically because sometimes, few Python packages or libraries cause issues with installing or running and hence we wanted to make sure we cover those details. If you are using any other OS like Linux or MacOSX, download the correct version for your OS and install it.

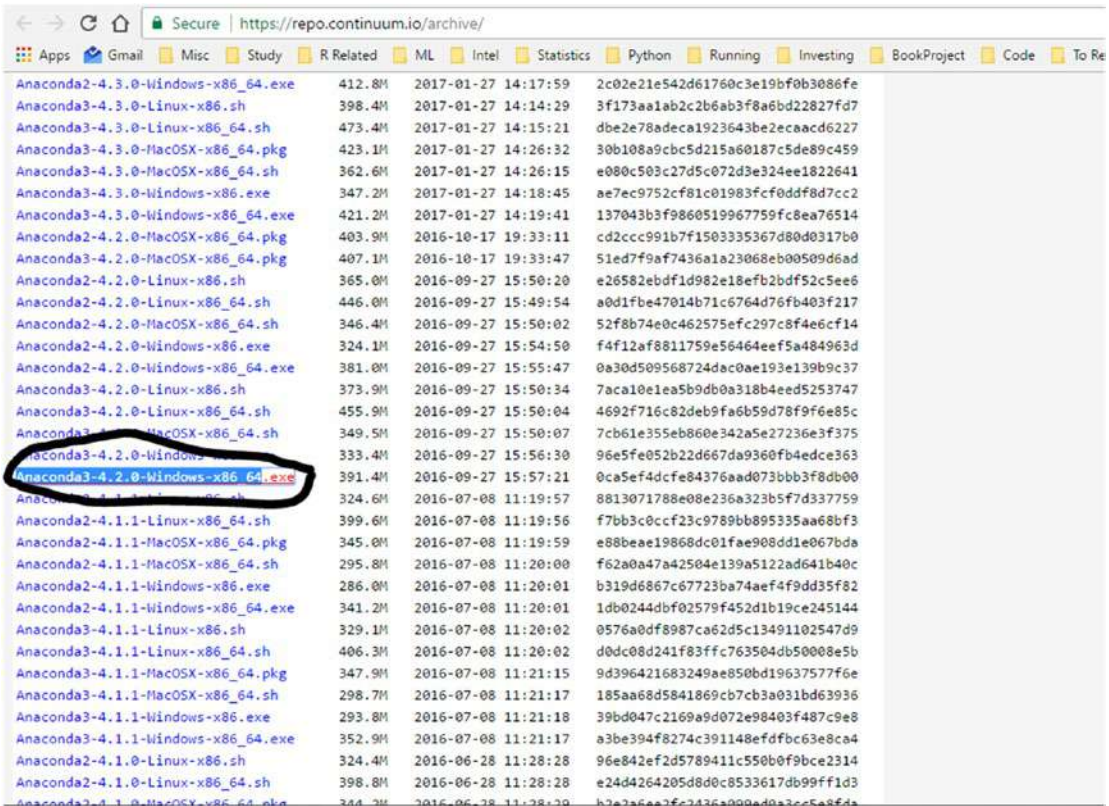

Figure 2-1. Downloading the Anaconda package

Installing the downloaded file is as simple as double-clicking the file and letting the installer take care of the entire process. To check if the installation was successful, just open a command prompt or terminal and start up Python. You should be greeted with the message shown in Figure 2-2 identifying the Python and the Anaconda version. We also recommend that you use the iPython shell (the command is `ipython`) instead of the regular Python shell, because you get a lot of features including inline plots, autocomplete, and so on.

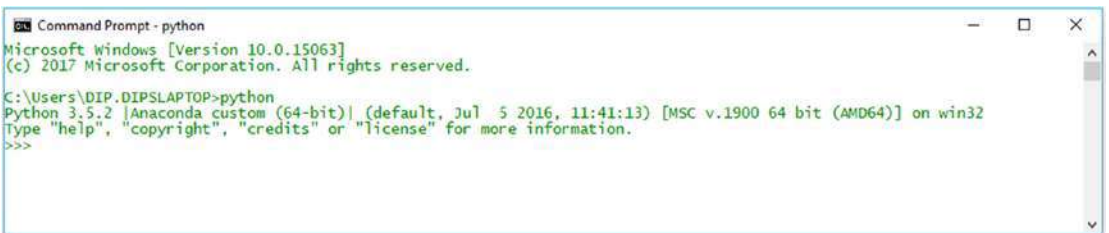

Figure 2-2. Verifying installation with the Python shell

This should complete the process of setting up your Python environment for Data Science and Machine Learning.

## Installing Libraries

We will not be covering the basics of Python, as we assume you are already acquainted with basic Python syntax. Feel free to check out any standard course or book on Python programming to pick up on the basics. We will cover one very basic but very important aspect of installing additional libraries. In Python the preferred way to install additional libraries is using the `pip` installer. The basic syntax to install a package from Python Package Index (PyPI) using `pip` is as follows.

```
pip install required_package
```

This will install the `required_package` if it is present in PyPI. We can also use other sources other than PyPI to install packages but that generally would not be required. The Anaconda distribution is already supplemented with a plethora of additional libraries, hence it is very unlikely that we will need additional packages from other sources.

Another way to install packages, limited to Anaconda, is to use the `conda install` command. This will install the packages from the Anaconda package channels and usually we recommend using this, especially on Windows.

## Why Python for Data Science?

According to a 2017 survey by StackOverflow (<https://insights.stackoverflow.com/survey/2017>), Python is world's 5th most used language. It is one of the top three languages used by data scientists and one of the most "wanted" language among StackOverflow users. In fact, in a recent poll by KDnuggets in 2017, Python got the maximum number of votes for being the leading platform for Analytics, Data Science, and Machine Learning based on the choice of users (<http://www.kdnuggets.com/2017/08/python-overtakes-r-leader-analytics-data-science.html>). Python has a lot of advantages that makes it a language of choice when it comes to the practices of Data Science. We will now try to illustrate these advantages and argue our case for "Why Python is a language of choice for Data scientists?"

## Powerful Set of Packages

Python is known for its extensive and powerful set of packages. In fact one of the philosophies shared by Python is *batteries included*, which means that Python has a rich and powerful set of packages ready to be used in a wide variety of domains and use cases. This philosophy is extended into the packages required for Data Science and Machine Learning. Packages like `numpy`, `scipy`, `pandas`, `scikit-learn`, etc., which are tailor-made for solving a variety of real-world Data Science problems, and are immensely powerful. This makes Python a go-to language for solving Data Science related problems.

## Easy and Rapid Prototyping

Python's simplicity is another important aspect when we want to discuss its suitability for Data Science. Python syntax is easy to understand as well as idiomatic, which makes comprehending existing code a relatively simple task. This allows the developer to easily modify existing implementations and develop his own ones. This feature is especially useful for developing new algorithms which may be experimental or yet to be supported by any external library. Based on what we discussed earlier, Python development is independent of time consuming *build* and *link* processes. Using the REPL shell, IDEs, and notebooks, you can rapidly build and iterate over multiple research and development cycles and all the changes can be readily made and tested.

## Easy to Collaborate

Data science solutions are rarely a one man job. Often a lot of collaboration is required in a Data Science team to develop a great analytical solution. Luckily Python provides tools that make it extremely easy to collaborate for a diverse team. One of the most liked features, which empowers this collaboration, are jupyter notebooks. Notebooks are a novel concept that allow data scientists to share the code, data, and insightful results in a single place. This makes for an easily reproducible research tool. We consider this to be a very important feature and will devote an entire section to cover the advantages offered by the use of notebooks.

## One-Stop Solution

In the first chapter we explored how Data Science as a field is interconnected to various domains. A typical project will have an iterative lifecycle that will involve data extraction, data manipulation, data analysis, feature engineering, modeling, evaluation, solution development, deployment, and continued updating of the solution. Python as a multi-purpose programming language is extremely diverse and it allows developers to address all these assorted operations from a common platform. Using Python libraries you can consume data from a multitude of sources, apply different data wrangling operations to that data, apply Machine Learning algorithms on the processed data, and deploy the developed solution. This makes Python extremely useful as no interface is required, i.e. you don't need to port any part of the whole pipeline to some different programming language. Also enterprise level Data Science projects often require interfacing with different programming languages, which is also achievable by using Python. For example, suppose some enterprise uses a custom made Java library for some esoteric data manipulation, then you can use Jython implementation of Python to use that Java library without writing custom code for the interfacing layer.

## Large and Active Community Support

The Python developer community is very active and humongous in number. This large community ensures that the core Python language and packages remain efficient and bug free. A developer can seek support about a Python issue using a variety of platforms like the Python mailing list, stack overflow, blogs, and usenet groups. This large support ecosystem is also one of the reasons for making Python a favored language for Data Science.

## Introducing the Python Machine Learning Ecosystem

In this section, we address the important components of the Python Machine Learning ecosystem and give a small introduction to each of them. These components are few of the reasons why Python is an important language for Data Science. This section is structured to give you a gentle introduction and acquaint you with these core Data Science libraries. Covering all of them in depth would be impractical and beyond the current scope since we would be using them in detail in subsequent chapters. Another advantage of having a great community of Python developers is the rich content that can be found about each one of these libraries with a simple search. The list of components that we cover is by no means exhaustive but we have shortlisted them on the basis of their importance in the whole ecosystem.

## Jupyter Notebooks

Jupyter notebooks, formerly known as ipython notebooks, are an interactive computational environment that can be used to develop Python based Data Science analyses, which emphasize on reproducible research. The interactive environment is great for development and enables us to easily share the notebook

and hence the code among peers who can replicate our research and analyses by themselves. These jupyter notebooks can contain code, text, images, output, etc., and can be arranged in a step by step manner to give a complete step by step illustration of the whole analysis process. This capability makes notebooks a valuable tool for reproducible analyses and research, especially when you want to share your work with a peer. While developing your analyses, you can document your thought process and capture the results as part of the notebook. This seamless intertwining of documentation, code, and results make jupyter notebooks a valuable tool for every data scientist.

We will be using jupyter notebooks, which are installed by default with our Anaconda distribution. This is similar to the ipython shell with the difference that it can be used for different programming backends, i.e. not just Python. But the functionality is similar for both of these with the added advantage of displaying interactive visualizations and much more on jupyter notebooks.

## Installation and Execution

We don't require any additional installation for Jupyter notebooks, as it is already installed by the Anaconda distribution. We can invoke the jupyter notebook by executing the following command at the command prompt or terminal.

```
C:\>jupyter notebook
```

This will start a notebook server at the address `localhost:8888` of your machine. An important point to note here is that you access the notebook using a browser so you can even initiate it on a remote server and use it locally using techniques like ssh tunneling. This feature is extremely useful in case you have a powerful computing resource that you can only access remotely but lack a GUI for it. Jupyter notebook allows you to access those resources in a visually interactive shell. Once you invoke this command, you can navigate to the address `localhost:8888` in your browser, to find the landing page depicted in Figure 2-3, which can be used to access existing notebooks or create new ones.

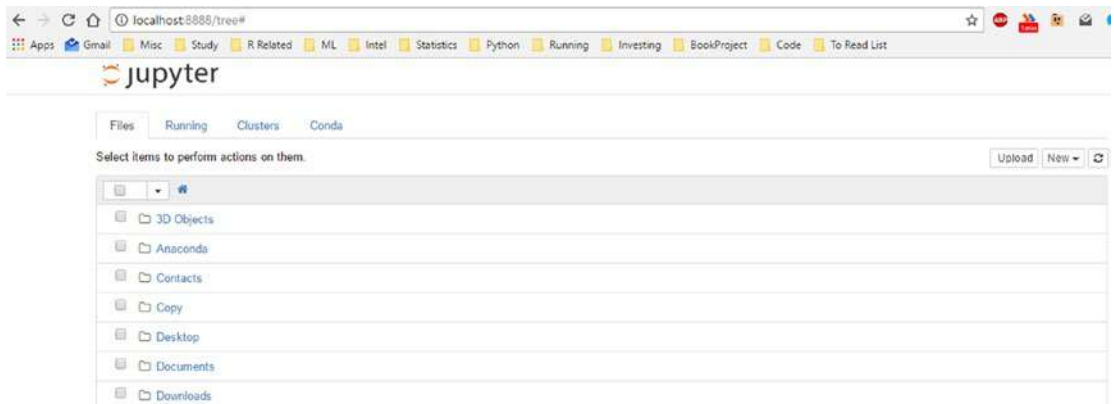

**Figure 2-3.** Jupyter notebook landing page

On the landing page we can initiate a new notebook by clicking the New button on top right. By default it will use the default kernel (i.e., the Python 3.5 kernel) but we can also associate the notebook with a

different kernel (for example a Python 2.7 kernel, if installed in your system). A notebook is just a collection of cells. There are three major types of cells in a notebook:

1. **Code cells:** Just like the name suggests, these are the cells that you can use to write your code and associated comments. The contents of these cells are sent to the kernel associated with the notebook and the computed outputs are displayed as the cells' outputs.
2. **Markdown cells:** Markdown can be used to intelligently notate the computation process. These can contain simple text comments, HTML tags, images, and even Latex equations. These will come in very handy when we are dealing with a new and non-standard algorithm and we also want to capture the stepwise math and logic related to the algorithm.
3. **Raw cells:** These are the simplest of the cells and they display the text written in them as is. These can be used to add text that you don't want to be converted by the conversion mechanism of the notebooks.

In Figure 2-4 we see a sample jupyter notebook, which touches on the ideas we just discussed in this section.

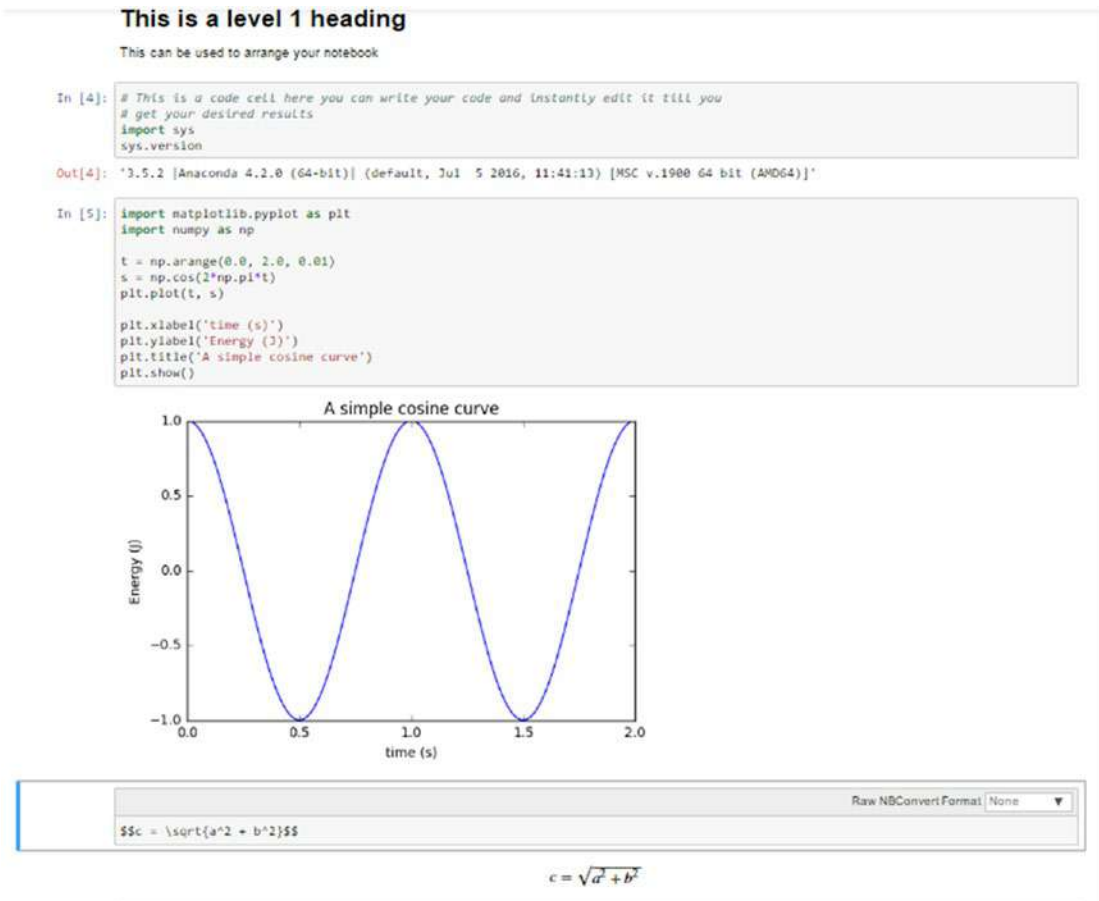

Figure 2-4. Sample jupyter notebook

## NumPy

NumPy is the backbone of Machine Learning in Python. It is one of the most important libraries in Python for numerical computations. It adds support to core Python for multi-dimensional arrays (and matrices) and fast vectorized operations on these arrays. The present day NumPy library is a successor of an early library, Numeric, which was created by [Jim Hugunin](#) and some other developers. Travis Oliphant, Anaconda's president and co-founder, took the Numeric library as a base and added a lot of modifications, to launch the present day NumPy library in 2005. It is a major open source project and is one of the most popular Python libraries. It's used in almost all Machine Learning and scientific computing libraries. The extent of popularity of NumPy is verified by the fact that major OS distributions, like Linux and MacOS, bundle NumPy as a default package instead of considering it as an add-on package.

## Numpy ndarray

All of the numeric functionality of `numpy` is orchestrated by two important constituents of the `numpy` package, `ndarray` and `Ufuncs` (Universal function). `Numpy ndarray` is a multi-dimensional array object which is the core data container for all of the `numpy` operations. Universal functions are the functions which operate on `ndarrays` in an element by element fashion. These are the lesser known members of the `numpy` package and we will try to give a brief introduction to them in the later stage of this section. We will mostly be learning about `ndarrays` in subsequent sections. (We will refer to them as arrays from now on for simplicity's sake.)

Arrays (or matrices) are one of the fundamental representations of data. Mostly an array will be of a single data type (homogeneous) and possibly multi-dimensional sometimes. The `numpy ndarray` is a generalization of the same. Let's get started with the introduction by creating an array.

```
In [4]: import numpy as np
...: arr = np.array([1,3,4,5,6])
...: arr
```

```
Out[4]: array([1, 3, 4, 5, 6])
```

```
In [5]: arr.shape
```

```
Out[5]: (5,)
```

```
In [6]: arr.dtype
```

```
Out[6]: dtype('int32')
```

In the previous example, we created a one-dimensional array from a normal list containing integers. The `shape` attribute of the array object will tell us about the dimensions of the array. The data type was picked up from the elements as they were all integers the data type is `int32`. One important thing to keep in mind is that all the elements in an array must have the same data type. If you try to initialize an array in which the elements are mixed, i.e. you mix some strings with the numbers then all of the elements will get converted into a string type and we won't be able to perform most of the `numpy` operations on that array. So a simple rule of thumb is dealing only with numeric data. You are encouraged to type in the following code in an `ipython` shell to look at the error message that comes up in such a scenario!

```
In [16]: arr = np.array([1,'st','er',3])
...: arr.dtype
Out[16]: dtype('<U11')
```

```
In [17]: np.sum(arr)
```

## Creating Arrays

Arrays can be created in multiple ways in `numpy`. One of the ways was demonstrated earlier to create a single-dimensional array. Similarly we can stack up multiple lists to create a multidimensional array.

```
In [19]: arr = np.array([[1,2,3],[2,4,6],[8,8,8]])
...: arr.shape
```

```
Out[19]: (3, 3)
```

```
In [20]: arr
```

```
Out[20]:
array([[1, 2, 3],
       [2, 4, 6],
       [8, 8, 8]])
```

In addition to this we can create arrays using a bunch of special functions provided by `numpy`.

**np.zeros:** Creates a matrix of specified dimensions containing only zeroes:

```
In [21]: arr = np.zeros((2,4))
...: arr
Out[21]:array([[ 0.,  0.,  0.,  0.],
               [ 0.,  0.,  0.,  0.]])
```

**np.ones:** Creates a matrix of specified dimension containing only ones:

```
In [22]: arr = np.ones((2,4))
...: arr
Out[22]:
array([[ 1.,  1.,  1.,  1.],
       [ 1.,  1.,  1.,  1.]])
```

**np.identity:** Creates an identity matrix of specified dimensions:

```
In [23]: arr = np.identity(3)
...: arr
Out[23]:
array([[ 1.,  0.,  0.],
       [ 0.,  1.,  0.],
       [ 0.,  0.,  1.]])
```

Often, an important requirement is to initialize an array of a specified dimension with random values. This can be done easily by using the `randn` function from the `numpy.random` package:

```
In [25]: arr = np.random.randn(3,4)
...: arr
Out[25]:
array([[ 0.0102692 , -0.13489664,  1.03821719, -0.28564286],
       [-1.12651838,  1.41684764,  1.11657566, -0.1909584 ],
       [ 2.20532043,  0.14813109,  0.73521382,  1.1270668 ]])
```



In practice, most of the arrays are created during reading in the data. We will cover the text data retrieval operations of `numpy` very briefly as we will try to use `pandas` generally, for our data ingestion process. (More on this in a later part of the chapter.)

One of the functions that we can use to read data from text file to a `numpy` array is `genfromtext`. This function can open a text file and read in data delimited by any character. (delimiter for a comma separated file is “,”). Since it is not our preferred way of retrieving data, we will give a brief example of the function here.

```
In [39]: b = BytesIO(b"2,23,33\n32,42,63.4\n35,77,12")
...: arr = np.genfromtxt(b, delimiter=",")
...: arr
```

```
Out[39]:
array([[ 2. , 23. , 33. ],
       [ 32. , 42. , 63.4],
       [ 35. , 77. , 12. ]])
```

## Accessing Array Elements

Once we have created an array by reading in our data, the next important part is to access that data using a wide variety of mechanisms. `Numpy` provides a lot of ways in which array elements can be accessed. We will try to give the most popular useful ways that facilitate this.

## Basic Indexing and Slicing

`Ndarray` can leverage the basic indexing operations that are followed by the `list` class, i.e. `list` object [`obj`]. If the `obj` is not an `ndarray` object, then the indexing is said to be basic indexing.

---

■ **Note** One important point to remember is that basic indexing will always return a view of the original array. It means that it will only refer to the original array and any change in values will be reflected in the original array also.

---

For example, if we want to access the complete second row of the array in one of the earlier examples, we can simply refer to it using `arr[1]`.

```
In [44]: arr[1]
Out[44]: array([32., 42., 63.4])
```

This access becomes interesting in the case of an array having more than two dimensions. Consider the following code snippet.

```
In [48]: arr = np.arange(12).reshape(2,2,3)
In [49]: arr
```

```
Out[49]:
array([[[ 0,  1,  2],
        [ 3,  4,  5]],
       [[ 6,  7,  8],
        [ 9, 10, 11]]])
```

```
In [50]: arr[0]
Out[50]:
array([[0, 1, 2],
       [3, 4, 5]])
```

Here we see that using a similar indexing scheme as above, we get an array having one lesser dimension than the original array.

The next important concept in accessing arrays is the concept of slicing arrays. Suppose we want to have a collection of elements only instead of all the elements. Then we can use slicing to access the elements. We will demonstrate the concept with a one-dimensional array.

```
In [57]: arr = np.arange(10)
...: arr[5:]
Out[57]: array([5, 6, 7, 8, 9])
```

```
In [58]: arr[5:8]
Out[58]: array([5, 6, 7])
```

```
In [60]: arr[:-5]
Out[60]: array([0, 1, 2, 3, 4])
```

If the number of dimensions in the object supplied is less than the dimension of the array being accessed then the colon (:) is assumed for all the dimensions. Consider the following example

```
In [13]: arr = np.arange(12).reshape(2,2,3)
...: arr
Out[13]:
array([[[ 0,  1,  2],
        [ 3,  4,  5]],

       [[ 6,  7,  8],
        [ 9, 10, 11]]])
```

```
In [14]: arr[1:2]
Out[14]:
array([[[ 6,  7,  8],
        [ 9, 10, 11]]])
```

Another way to access an array is to use dots (...) based indexing. Suppose in a three-dimensional array we want to access the value of only one column. We can do it in two ways.

```
In [8]: arr = np.arange(27).reshape(3,3,3)
...: arr
Out[8]:
array([[[ 0,  1,  2],
        [ 3,  4,  5],
        [ 6,  7,  8]],

       [[ 9, 10, 11],
        [12, 13, 14],
        [15, 16, 17]],

       [[18, 19, 20],
        [21, 22, 23],
        [24, 25, 26]]])
```

```
[[18, 19, 20],
 [21, 22, 23],
 [24, 25, 26]])
```

Now if we want to access the third column, we can use two different notations to access that column:

```
In [10]: arr[:, :, 2]
Out[10]:
array([[ 2,  5,  8],
       [11, 14, 17],
       [20, 23, 26]])
```

We can also use a dot notation in the following way. Both of the methods gets us the same value but the dot notation is concise. The dot notation stands for as many colons as required to complete an indexing operation.

```
In [11]: arr[... , 2]
Out[11]:
array([[ 2,  5,  8],
       [11, 14, 17],
       [20, 23, 26]])
```

## Advanced Indexing

The difference in advanced indexing and basic indexing comes from the type of object being used to reference the array. If the object is an ndarray object (data type int or bool) or a non-tuple sequence object or a tuple object containing an ndarray (data type integer or bool), then the indexing being done on the array is said to be advanced indexing.

---

■ **Note** Advanced indexing will always return the copy of the original array data.

---

**Integer array indexing:** This advanced indexing occurs when the reference object is also an array. The simplest type of indexing is when we provide an array that's equal in dimensions to the array being accessed. For example:

```
In [19]: arr = np.arange(9).reshape(3,3)
...: arr
Out[19]:
array([[0, 1, 2],
       [3, 4, 5],
       [6, 7, 8]])
```

```
In [20]: arr[[0,1,2],[1,0,0]]
Out[20]: array([1, 3, 6])
```

In this example we have provided an array in which the first part identifies the rows we want to access and the second identifies the columns which we want to address. This is quite similar to providing a collective element-wise address.

**Boolean indexing:** This advanced indexing occurs when the reference object is an array of Boolean values. This is used when we want to access data based on some conditions, in that case, Boolean indexing can be used. We will illustrate it with an example. Suppose in one array, we have the names of some cities and in another array, we have some data related to those cities.

```
In [3]: cities = np.array(["delhi","bangalore","mumbai","chennai","bhopal"])
...: city_data = np.random.randn(5,3)
...: city_data
Out[3]:array([[ 1.78780089, -0.25099029, -0.26002244],
 [ 1.41016167, -0.43878679,  0.4912639 ],
 [-0.32176723, -0.01912549, -1.22891881],
 [-0.93371835, -0.03604015, -0.37319556],
 [ 1.48625779,  0.62758167,  0.77321756]])
```

```
In [4]: city_data[cities == "delhi"]
Out[4]: array([[ 1.78780089, -0.25099029, -0.26002244]])
```

We can also use Boolean indexing for selecting some elements of an array that satisfy a particular condition. For example, in the previous array suppose we want to only select non-zero elements. We can do that easily using the following code.

```
In [6]: city_data[city_data > 0]
Out[6]:
array([ 1.78780089,  1.41016167,  0.4912639 ,  1.48625779,  0.62758167,
        0.77321756])
```

We observe that the shape of the array is not maintained so we directly cannot always use this indexing method. But this method is quite useful in doing conditional data substitution. Suppose in the previous case, we want to substitute all the non-zero values with 0. We can achieve that operation by the following code.

```
In [7]: city_data[city_data > 0] = 0
...: city_data
Out[7]:
array([[ 0.          , -0.25099029, -0.26002244],
 [ 0.          , -0.43878679,  0.          ],
 [-0.32176723, -0.01912549, -1.22891881],
 [-0.93371835, -0.03604015, -0.37319556],
 [ 0.          ,  0.          ,  0.          ]])
```

## Operations on Arrays

At the start of this section, we mentioned the concept of Universal functions (Ufuncs). In this sub-section, we learn some of the functionalities provided by those functions. Most of the operations on the numpy arrays is achieved by using these functions. Numpy provides a rich set of functions that we can leverage for various operations on arrays. We cover some of those functions in brief, but we recommend you to always refer to the official documentation of the project to learn more and leverage them in your own projects.

Universal functions are functions that operate on arrays in an element by element fashion. The implementation of Ufunc is vectorized, which means that the execution of Ufuncs on arrays is quite fast. The Ufuncs implemented in the numpy package are implemented in compiled C code for speed and efficiency. But it is possible to write custom functions by extending the `numpy.ufunc` class of the numpy package.

Ufuncs are simple and easy to understand once you are able to relate the output they produce on a particular array.

```
In [23]: arr = np.arange(15).reshape(3,5)
...: arr
...:
```

```
Out[23]:
array([[ 0,  1,  2,  3,  4],
       [ 5,  6,  7,  8,  9],
       [10, 11, 12, 13, 14]])
```

```
In [24]: arr + 5
```

```
Out[24]:
array([[ 5,  6,  7,  8,  9],
       [10, 11, 12, 13, 14],
       [15, 16, 17, 18, 19]])
```

```
In [25]: arr * 2
```

```
Out[25]:
array([[ 0,  2,  4,  6,  8],
       [10, 12, 14, 16, 18],
       [20, 22, 24, 26, 28]])
```

We see that the standard operators when used in conjunction with arrays work element-wise. Some Ufuncs will take two arrays as input and output a single array, while a rare few will output two arrays also.

```
In [29]: arr1 = np.arange(15).reshape(5,3)
...: arr2 = np.arange(5).reshape(5,1)
...: arr2 + arr1
```

```
Out[29]:
array([[ 0,  1,  2],
       [ 4,  5,  6],
       [ 8,  9, 10],
       [12, 13, 14],
       [16, 17, 18]])
```

```
In [30]: arr1
```

```
Out[30]:
array([[ 0,  1,  2],
       [ 3,  4,  5],
       [ 6,  7,  8],
       [ 9, 10, 11],
       [12, 13, 14]])
```

```
In [31]: arr2
```

```
Out[31]:
```

```
array([[0],
       [1],
       [2],
       [3],
       [4]])
```

Here we see that we were able to add up two arrays even when they were of different sizes. This is achieved by the concept of *broadcasting*. We will conclude this brief discussion on operations on arrays by demonstrating a function that will return two arrays.

```
In [32]: arr1 = np.random.randn(5,3)
...: arr1
Out[32]:
array([[ -0.57863219, -0.36613451, -0.92311378],
       [ 0.81557068,  0.20486617, -0.16740779],
       [ 0.73806067,  1.30173294,  0.6144705 ],
       [ 0.26294157, -0.09300711,  1.1794524 ],
       [ 0.25011242, -0.65374314, -0.57663904]])
```

```
In [35]: np.modf(arr1)
Out[35]:
(array([[ -0.57863219, -0.36613451, -0.92311378],
       [ 0.81557068,  0.20486617, -0.16740779],
       [ 0.73806067,  0.30173294,  0.6144705 ],
       [ 0.26294157, -0.09300711,  0.1794524 ],
       [ 0.25011242, -0.65374314, -0.57663904]]),
 array([[ -0., -0., -0.],
       [ 0.,  0., -0.],
       [ 0.,  1.,  0.],
       [ 0., -0.,  1.],
       [ 0., -0., -0.]])
```

The function `modf` will return the fractional and the integer part of the input supplied to it. Hence it will return two arrays of the same size. We tried to give you a basic idea of the operations on arrays provided by the `numpy` package. But this list is not exhaustive; for the complete list you can refer to the reference page for `Ufuncs` at <https://docs.scipy.org/doc/numpy/reference/ufuncs.html>.

## Linear Algebra Using `numpy`

Linear algebra is an integral part of the domain of Machine Learning. Most of the algorithms we will deal with can be concisely expressed using the operations of linear algebra. `Numpy` was initially built to provide the functions similar to `MATLAB` and hence linear algebra functions on arrays were always an important part of it. In this section, we learn a bit about performing linear algebra on `ndarrays` using the functions implemented in the `numpy` package.

One of the most widely used operations in linear algebra is the dot product. This can be performed on two compatible (brush up on your matrices and array skills if you need to know which arrays are compatible for a dot product) `ndarrays` by using the `dot` function.

```
In [39]: A = np.array([[1,2,3],[4,5,6],[7,8,9]])
...: B = np.array([[9,8,7],[6,5,4],[1,2,3]])
```

```
In [40]: A.dot(B)
Out[40]:
array([[ 24,  24,  24],
       [ 72,  69,  66],
       [120, 114, 108]])
```

Similarly, there are functions implemented for finding different products of matrices like inner, outer, and so on. Another popular matrix operation is transpose of a matrix. This can be easily achieved by using the T function.

```
In [41]: A = np.arange(15).reshape(3,5)
In [46]: A.T
Out[46]:
array([[ 0,  5, 10],
       [ 1,  6, 11],
       [ 2,  7, 12],
       [ 3,  8, 13],
       [ 4,  9, 14]])
```

Oftentimes, we need to find out decomposition of a matrix into its constituents factors. This is called matrix factorization. This can be achieved by the appropriate functions. A popular matrix factorization method is SVD factorization (covered briefly in Chapter 1 concepts), which returns decomposition of a matrix into three different matrices. This can be done using `linalg.svd` function.

```
In [48]: np.linalg.svd(A)
Out[48]:
(array([[ -0.15425367,  0.89974393,  0.40824829],
       [ -0.50248417,  0.28432901, -0.81649658],
       [ -0.85071468, -0.3310859 ,  0.40824829]]),
 array([ 3.17420265e+01,  2.72832424e+00,  4.58204637e-16]),
 array([[ -0.34716018, -0.39465093, -0.44214167, -0.48963242, -0.53712316],
       [ -0.69244481, -0.37980343, -0.06716206,  0.24547932,  0.55812069],
       [  0.33717486, -0.77044776,  0.28661392,  0.38941603, -0.24275704],
       [ -0.36583339,  0.32092943, -0.08854543,  0.67763613, -0.54418674],
       [ -0.39048565,  0.05843412,  0.8426222 , -0.29860414, -0.21196653]]))
```

Linear algebra is often also used to solve a system of equations. Using the matrix notation of system of equations and the provided function of `numpy`, we can easily solve such a system of equation. Consider the system of equations:

$$\begin{aligned} 7x + 5y - 3z &= 16 \\ 3x - 5y + 2z &= -8 \\ 5x + 3y - 7z &= 0 \end{aligned}$$

This can be represented as two matrices: the coefficient matrix (a in the example) and the constants vector (b in the example).

```
In [51]: a = np.array([[7,5,-3], [3,-5,2],[5,3,-7]])
...: b = np.array([16,-8,0])
...: x = np.linalg.solve(a, b)
...: x
```

```
Out[51]: array([ 1.,  3.,  2.])
```

We can also check if the solution is correct using the `np.allclose` function.

```
In [52]: np.allclose(np.dot(a, x), b)
Out[52]: True
```

Similarly, functions are there for finding the inverse of a matrix, eigen vectors and eigen values of a matrix, norm of a matrix, determinant of a matrix, and so on, some of which we covered in detail in Chapter 1. Take a look at the details of the function implemented at <https://docs.scipy.org/doc/numpy/reference/routines.linalg.html>.

## Pandas

Pandas is an important Python library for data manipulation, wrangling, and analysis. It functions as an intuitive and easy-to-use set of tools for performing operations on any kind of data. Initial work for pandas was done by Wes McKinney in 2008 while he was a developer at AQR Capital Management. Since then, the scope of the pandas project has increased a lot and it has become a popular library of choice for data scientists all over the world. Pandas allows you to work with both cross-sectional data and time series based data. So let's get started exploring pandas!

## Data Structures of Pandas

All the data representation in pandas is done using two primary data structures:

- Series
- Dataframes

## Series

Series in pandas is a one-dimensional ndarray with an axis label. It means that in functionality, it is almost similar to a simple array. The values in a series will have an index that needs to be hashable. This requirement is needed when we perform manipulation and summarization on data contained in a series data structure. Series objects can be used to represent time series data also. In this case, the index is a `datetime` object.

## Dataframe

Dataframe is the most important and useful data structure, which is used for almost all kind of data representation and manipulation in pandas. Unlike numpy arrays (in general) a dataframe can contain heterogeneous data. Typically tabular data is represented using dataframes, which is analogous to an Excel sheet or a SQL table. This is extremely useful in representing raw datasets as well as processed feature sets in Machine Learning and Data Science. All the operations can be performed along the axes, rows, and columns, in a dataframe. This will be the primary data structure which we will leverage, in most of the use cases in our later chapters.



## Data Retrieval

Pandas provides numerous ways to retrieve and read in data. We can convert data from CSV files, databases, flat files, and so on into dataframes. We can also convert a list of dictionaries (Python dict) into a dataframe. The sources of data which pandas allows us to handle cover almost all the major data sources. For our introduction, we will cover three of the most important data sources:

- List of dictionaries
- CSV files
- Databases

### List of Dictionaries to Dataframe

This is one of the simplest methods to create a dataframe. It is useful in scenarios where we arrive at the data we want to analyze, after performing some computations and manipulations on the raw data. This allows us to integrate a pandas based analysis into data being generated by other Python processing pipelines.

```
In[27]: import pandas as pd
In[28]: d = [{'city': 'Delhi', "data": 1000},
...:        {'city': 'Bangalore', "data": 2000},
...:        {'city': 'Mumbai', "data": 1000}]
In[29]: pd.DataFrame(d)
Out[29]:
```

	city	data
0	Delhi	1000
1	Bangalore	2000
2	Mumbai	1000

```
In[30]: df = pd.DataFrame(d)
In[31]: df
Out[31]:
```

	city	data
0	Delhi	1000
1	Bangalore	2000
2	Mumbai	1000

Here we provided a list of Python dictionaries to the DataFrame class of the pandas library and the dictionary was converted into a DataFrame. Two important things to note here: first the keys of dictionary are picked up as the column names in the dataframe (we can also supply some other name as arguments for different column names), secondly we didn't supply an index and hence it picked up the default index of normal arrays.

### CSV Files to Dataframe

CSV (Comma Separated Files) files are perhaps one of the most widely used ways of creating a dataframe. We can easily read in a CSV, or any delimited file (like TSV), using pandas and convert into a dataframe. For our example we will read in the following file and convert into a dataframe by using Python. The data in Figure 2-5 is a sample slice of a CSV file containing the data of cities of the world from <http://simplemaps.com/data/world-cities>. We will use the same data in a later part of this chapter also.

```

city,city_ascii,lat,lng,pop,country,iso2,iso3,province
Qal eh-ye Now,Qal eh-ye,34.98300013,63.13329964,2997,Afghanistan,AF,AFG,Badghis
Chaghcharan,Chaghcharan,34.5167011,65.25000063,15000,Afghanistan,AF,AFG,Ghor
Lashkar Gah,Lashkar Gah,31.58299802,64.35999955,201546,Afghanistan,AF,AFG,Hilmand
Zaranj,Zaranj,31.11200108,61.88699752,49851,Afghanistan,AF,AFG,Nimroz
Tarin Kowt,Tarin Kowt,32.63329815,65.86669865,10000,Afghanistan,AF,AFG,Uruzgan
Zareh Sharan,Zareh Sharan,32.85000016,68.41670453,13737,Afghanistan,AF,AFG,Paktika
Asadabad,Asadabad,34.86600004,71.15000459,48400,Afghanistan,AF,AFG,Kunar
Taloqan,Taloqan,36.72999904,69.54000364,64256,Afghanistan,AF,AFG,Takhar
Mahmud-E Eraqi,Mahmud-E Eraqi,35.01669608,69.33330065,7407,Afghanistan,AF,AFG,Kapisa
Mehtar Lam,Mehtar Lam,34.65000001,70.16670052,17345,Afghanistan,AF,AFG,Laghman
Baraki Barak,Baraki Barak,33.9667021,68.96670354,22305,Afghanistan,AF,AFG,Logar
Aybak,Aybak,36.26100015,68.04000051,24000,Afghanistan,AF,AFG,Samangan

```

**Figure 2-5.** A sample CSV file

We can convert this file into a dataframe with the help of the following code leveraging pandas.

```

In [1]: import pandas as pd

In [2]: city_data = pd.read_csv(filepath_or_buffer='simplemaps-worldcities-basic.csv')
In [3]: city_data.head(n=10)
Out[3]:
city city_ascii lat lng pop country \
0 Qal eh-ye Now Qal eh-ye 34.983000 63.133300 2997 Afghanistan
1 Chaghcharan Chaghcharan 34.516701 65.250001 15000 Afghanistan
2 Lashkar Gah Lashkar Gah 31.582998 64.360000 201546 Afghanistan
3 Zaranj Zaranj 31.112001 61.886998 49851 Afghanistan
4 Tarin Kowt Tarin Kowt 32.633298 65.866699 10000 Afghanistan
5 Zareh Sharan Zareh Sharan 32.850000 68.416705 13737 Afghanistan
6 Asadabad Asadabad 34.866000 71.150005 48400 Afghanistan
7 Taloqan Taloqan 36.729999 69.540004 64256 Afghanistan
8 Mahmud-E Eraqi Mahmud-E Eraqi 35.016696 69.333301 7407 Afghanistan
9 Mehtar Lam Mehtar Lam 34.650000 70.166701 17345 Afghanistan

iso2 iso3 province
0 AF AFG Badghis
1 AF AFG Ghor
2 AF AFG Hilmand
3 AF AFG Nimroz
4 AF AFG Uruzgan
5 AF AFG Paktika
6 AF AFG Kunar
7 AF AFG Takhar
8 AF AFG Kapisa
9 AF AFG Laghman

```

As the file we supplied had a header included, those values were used as the name of the columns in the resultant dataframe. This is a very basic yet core usage of the function `pandas.read_csv`. The function comes with a multitude of parameters that can be used to modify its behavior as required. We will not cover

the entire gamut of parameters available and you are encouraged to read the documentation of this function as this is one of the starting point of most Python based data analysis.

## Databases to Dataframe

The most important data source for data scientists is the existing data sources used by their organizations. Relational databases (DBs) and data warehouses are the de facto standard of data storage in almost all of the organizations. Pandas provides capabilities to connect to these databases directly, execute queries on them to extract data, and then convert the result of the query into a structured dataframe. The `pandas.read_sql` function combined with Python's powerful database library implies that the task of getting data from DBs is simple and easy. Due to this capability, no intermediate steps of data extraction are required. We will now take an example of reading data from a Microsoft SQL Server database. The following code will achieve this task.

```
server = 'xxxxxxx' # Address of the database server
user = 'xxxxxx' # the username for the database server
password = 'xxxxxx' # Password for the above user
database = 'xxxxxx' # Database in which the table is present
conn = pymssql.connect(server=server, user=user, password=password, database=database)
query = "select * from some_table"
df = pd.read_sql(query, conn)
```

The important thing to notice here is the connection object (`conn` in the code). This object is the one which will identify the database server information and the type of database to pandas. Based on the endpoint database server we will change the connection object. For example we are using the `pymssql` library for access to Microsoft SQL server here. If our data source is changed to a Postgres database, the connection object will change but the rest of the procedure will be similar. This facility is really handy when we need to perform similar analyses on data originating from different sources. Once again, the `read_sql` function of pandas provides a lot of parameters that allow us to control its behavior. We also recommend you to check out the `sqlalchemy` library, which makes creating connection objects easier irrespective of the type of database vendor and also provides a lot of other utilities.

## Data Access

The most important part after reading in our data is that of accessing that data using the data structure's access mechanisms. Accessing data in the pandas dataframe and series objects is very much similar to the access mechanism that exist for Python lists or numpy arrays. But they also offer some extra methods for data access specific to dataframe/series.

## Head and Tail

In the previous section we witnessed the method `head`. It gives us the first few rows (by default 5) of the data. A corresponding function is `tail`, which gives us the last few rows of the dataframe. These are one of the most widely used pandas functions, as we often need to take a peek at our data as and when we apply different operations/selections on it. We already have seen the output of `head`, so we'll use the `tail` function on the same dataframe and see its output.

```
In [11]: city_data.tail()
Out[11]:
city city_ascii lat lng pop country \
7317 Mutare Mutare -18.970019 32.650038 216785.0 Zimbabwe
```

```

7318 Kadoma Kadoma -18.330006 29.909947 56400.0 Zimbabwe
7319 Chitungwiza Chitungwiza -18.000001 31.100003 331071.0 Zimbabwe
7320 Harare Harare -17.817790 31.044709 1557406.5 Zimbabwe
7321 Bulawayo Bulawayo -20.169998 28.580002 697096.0 Zimbabwe

```

```

iso2 iso3 province
7317 ZW ZWE Manicaland
7318 ZW ZWE Mashonaland West
7319 ZW ZWE Harare
7320 ZW ZWE Harare
7321 ZW ZWE Bulawayo

```

## Slicing and Dicing

The usual rules of slicing and dicing data that we used in Python lists apply to the Series object as well.

```

In [12]: series_es = city_data.lat
In [13]: type(series_es)
Out[13]: pandas.core.series.Series

```

```

In [14]: series_es[1:10:2]
Out[14]:
1 34.516701
3 31.112001
5 32.850000
7 36.729999
9 34.650000
Name: lat, dtype: float64

```

```

In [15]: series_es[:7]
Out[15]:
0 34.983000
1 34.516701
2 31.582998
3 31.112001
4 32.633298
5 32.850000
6 34.866000
Name: lat, dtype: float64

```

```

In [23]: series_es[:-7315]
Out[23]:
0 34.983000
1 34.516701
2 31.582998
3 31.112001
4 32.633298
5 32.850000
6 34.866000
Name: lat, dtype: float64

```

The examples given here are self-explanatory and you can refer to the numpy section for more details.

Similar slicing rules apply for dataframes also but the only difference is that now simple slicing refers to the slicing of rows and all the other columns will end up in the result. Consider the following example

```
In [24]: city_data[:7]
Out[24]:
city city_ascii lat lng pop country \
0 Qal eh-ye Now Qal eh-ye 34.983000 63.133300 2997 Afghanistan
1 Chaghcharan Chaghcharan 34.516701 65.250001 15000 Afghanistan
2 Lashkar Gah Lashkar Gah 31.582998 64.360000 201546 Afghanistan
3 Zaranj Zaranj 31.112001 61.886998 49851 Afghanistan
4 Tarin Kowt Tarin Kowt 32.633298 65.866699 10000 Afghanistan
5 Zareh Sharan Zareh Sharan 32.850000 68.416705 13737 Afghanistan
6 Asadabad Asadabad 34.866000 71.150005 48400 Afghanistan

iso2 iso3 province
0 AF AFG Badghis
1 AF AFG Ghor
2 AF AFG Hilmand
3 AF AFG Nimroz
4 AF AFG Uruzgan
5 AF AFG Paktika
6 AF AFG Kunar
```

For providing access to specific rows and specific columns, pandas provides useful functions like `iloc` and `loc` which can be used to refer to specific rows and columns in a dataframe. There is also the `ix` function but we recommend using either `loc` or `iloc`. The following examples leverages the `iloc` function provided by pandas. This allows us to select the rows and columns using structure similar to array slicing. In the example, we will only pick up the first five rows and the first four columns.

```
In [28]: city_data.iloc[:5,:4]

Out[28]:
city city_ascii lat lng
0 Qal eh-ye Now Qal eh-ye 34.983000 63.133300
1 Chaghcharan Chaghcharan 34.516701 65.250001
2 Lashkar Gah Lashkar Gah 31.582998 64.360000
3 Zaranj Zaranj 31.112001 61.886998
4 Tarin Kowt Tarin Kowt 32.633298 65.866699
```

Another access mechanism is Boolean based access to the dataframe rows or columns. This is particularly important for dataframes, as it allows us to work with a specific set of rows and columns. Let's consider the following example in which we want to select cities that have population of more than 10 million and select columns that start with the letter `l`:

```
In [56]: city_data[city_data['pop'] >
          10000000][city_data.columns[pd.Series(city_data.columns).str.
          startswith('l')]]

Out[53]:
lat lng
```

```

360 -34.602502 -58.397531
1171 -23.558680 -46.625020
2068 31.216452 121.436505
3098 28.669993 77.230004
3110 19.016990 72.856989
3492 35.685017 139.751407
4074 19.442442 -99.130988
4513 24.869992 66.990009
5394 55.752164 37.615523
6124 41.104996 29.010002
7071 40.749979 -73.980017

```

When we select data based on some condition, we always get the part of dataframe that satisfies the condition supplied. Sometimes we want to test a condition against a dataframe but want to preserve the shape of the dataframe. In these cases, we can use the where function (check out numpy's where function also to see the analogy!). We'll illustrate this function with an example in which we will try to select all the cities that have population greater than 15 million.

```

In [6]: city_greater_10mil = city_data[city_data['pop'] > 10000000]
In [23]: city_greater_10mil.where(city_greater_10mil.population > 15000000)
Out[23]:
city city_ascii lat lng population country iso2 iso3 \
360 NaN NaN NaN NaN NaN NaN NaN NaN
1171 NaN NaN NaN NaN NaN NaN NaN NaN
2068 NaN NaN NaN NaN NaN NaN NaN NaN
3098 NaN NaN NaN NaN NaN NaN NaN NaN
3110 Mumbai Mumbai 19.016990 72.856989 15834918.0 India IN IND
3492 Tokyo Tokyo 35.685017 139.751407 22006299.5 Japan JP JPN
4074 NaN NaN NaN NaN NaN NaN NaN NaN
4513 NaN NaN NaN NaN NaN NaN NaN NaN
5394 NaN NaN NaN NaN NaN NaN NaN NaN
6124 NaN NaN NaN NaN NaN NaN NaN NaN
7071 NaN NaN NaN NaN NaN NaN NaN NaN

```

```

province
360 NaN
1171 NaN
2068 NaN
3098 NaN
3110 Maharashtra
3492 Tokyo
4074 NaN
4513 NaN
5394 NaN
6124 NaN
7071 NaN

```

Here we see that we get the output dataframe of the same size but the rows that don't conform to the condition are replaced with NaN.

In this section, we learned some of the core data access mechanisms of pandas dataframes. The data access mechanism of pandas are as simple and extensive to use as with `numpy` this ensures that we have various way to access our data.

## Data Operations

In subsequent chapters of our book, the pandas dataframe will be our data structure of choice for most data processing and wrangling operations. So we would like to spend some more time exploring some important operations that can be performed on dataframes using specific supplied functions.

### Values Attribute

Each pandas dataframe will have certain attributes. One of the important attributes is `values`. It is important as it allows us access to the raw values stored in the dataframe and if they all homogenous i.e., of the same kind then we can use `numpy` operations on them. This becomes important when our data is a mix of numeric and other data types and after some selections and computations, we arrive at the required subset of numeric data. Using the `values` attribute of the output dataframe, we can treat it in the same way as a `numpy` array. This is very useful when working with feature sets in Machine Learning. Traditionally, `numpy` vectorized operations are much faster than function based operations on dataframes.

```
In [55]: df = pd.DataFrame(np.random.randn(8, 3),
...:                      columns=['A', 'B', 'C'])
```

```
In [56]: df
```

```
Out[56]:
```

	A	B	C
0	-0.271131	0.084627	-1.707637
1	1.895796	0.590270	-0.505681
2	-0.628760	-1.623905	1.143701
3	0.005082	1.316706	-0.792742
4	0.135748	-0.274006	1.989651
5	1.068555	0.669145	0.128079
6	-0.783522	0.167165	-0.426007
7	0.498378	-0.950698	2.342104

```
In [58]: nparray = df.values
```

```
In [59]: type(nparray)
```

```
Out[59]: numpy.ndarray
```

### Missing Data and the `fillna` Function

In real-world datasets, the data is seldom clean and polished. We usually will have a lot of issues with data quality (missing values, wrong values and so on). One of the most common data quality issues is that of missing data. Pandas provides us with a convenient function that allows us to handle the missing values of a dataframe.

For demonstrating the use of the `fillna` function, we will use the dataframe we created in the previous example and introduce missing values in it.

```
In [65]: df.iloc[4,2] = NA
```

```
In [66]: df
```

```
Out[66]:
```

```

      A      B      C
0 -0.271131  0.084627 -1.707637
1  1.895796  0.590270 -0.505681
2 -0.628760 -1.623905  1.143701
3  0.005082  1.316706 -0.792742
4  0.135748 -0.274006    NaN
5  1.068555  0.669145  0.128079
6 -0.783522  0.167165 -0.426007
7  0.498378 -0.950698  2.342104

```

```
In [70]: df.fillna (0)
```

```
Out[70]:
```

```

      A      B      C
0 -0.271131  0.084627 -1.707637
1  1.895796  0.590270 -0.505681
2 -0.628760 -1.623905  1.143701
3  0.005082  1.316706 -0.792742
4  0.135748 -0.274006  0.000000
5  1.068555  0.669145  0.128079
6 -0.783522  0.167165 -0.426007
7  0.498378 -0.950698  2.342104

```

Here we have substituted the missing value with a default value. We can use a variety of methods to arrive at the substituting value (mean, median, and so on). We will see more methods of missing value treatment (like imputation) in subsequent chapters.

## Descriptive Statistics Functions

A general practice of dealing with datasets is to know as much about them as possible. Descriptive statistics of a dataframe give data scientists a comprehensive look into important information about any attributes and features in the dataset. Pandas packs a bunch of functions, which facilitate easy access to these statistics.

Consider the cities dataframe (`city_data`) that we consulted in the earlier section. We will use pandas functions to gather some descriptive statistical information about the attributes of that dataframe. As we only have three numeric columns in that particular dataframe, we will deal with a subset of the dataframe which contains only those three values.

```
In [76]: columns_numeric = ['lat', 'lng', 'pop']
```

```
In [78]: city_data[columns_numeric].mean()
```

```
Out[78]:
```

```

lat      20.662876
lng      10.711914
pop     265463.071633
dtype: float64

```

```
In [79]: city_data[columns_numeric].sum()
```

```
Out[79]:
```

```

lat      1.512936e+05
lng      7.843263e+04
pop     1.943721e+09
dtype: float64

```



```

In [80]: city_data[columns_numeric].count()
Out[80]:
lat    7322
lng    7322
pop    7322
dtype: int64

In [81]: city_data[columns_numeric].median()
Out[81]:
lat      26.792730
lng      18.617509
pop    61322.750000
dtype: float64

In [83]: city_data[columns_numeric].quantile(0.8)
Out[83]:
lat      46.852480
lng      89.900018
pop    269210.000000
dtype: float64

```

All these operations were applied to each of the columns, the default behavior. We can also get all these statistics for each row by using a different axis. This will give us the calculated statistics for each row in the dataframe.

```

In [85]: city_data[columns_numeric].sum(axis = 1)
Out[85]:
0    3.095116e+03
1    1.509977e+04
2    2.016419e+05
3    4.994400e+04
4    1.009850e+04

```

Pandas also provides us with another very handy function called `describe`. This function will calculate the most important statistics for numerical data in one go so that we don't have to use individual functions.

```

In [86]: city_data[columns_numeric].describe()
Out[86]:

```

	lat	lng	pop
count	7322.000000	7322.000000	7.322000e+03
mean	20.662876	10.711914	2.654631e+05
std	29.134818	79.044615	8.287622e+05
min	-89.982894	-179.589979	-9.900000e+01
25%	-0.324710	-64.788472	1.734425e+04
50%	26.792730	18.617509	6.132275e+04
75%	43.575448	73.103628	2.001726e+05
max	82.483323	179.383304	2.200630e+07

## Concatenating Dataframes

Most Data Science projects will have data from more than one data source. These data sources will mostly have data that's related in some way to each other and the subsequent steps in data analysis will require them to be concatenated or joined. Pandas provides a rich set of functions that allow us to merge different data sources. We cover a small subset of such methods. In this section, we explore and learn about two methods that can be used to perform all kinds of amalgamations of dataframes.

### Concatenating Using the `concat` Method

The first method to concatenate different dataframes in pandas is by using the `concat` method. The majority of the concatenation operations on dataframes will be possible by tweaking the parameters of the `concat` method. Let's look at a couple of examples to understand how the `concat` method works.

The simplest scenario of concatenating is when we have more than one fragment of the same dataframe (which may happen if you are reading it from a stream or in chunks). In that case, we can just supply the constituent dataframes to the `concat` function as follows.

```
In [25]: city_data1 = city_data.sample(3)
In [26]: city_data2 = city_data.sample(3)
In [29]: city_data_combine = pd.concat([city_data1,city_data2])
In [30]: city_data_combine
Out[30]:
city city_ascii lat lng pop \
4255 Groningen Groningen 53.220407 6.580001 198941.0
5171 Tambov Tambov 52.730023 41.430019 296207.5
4204 Karibib Karibib -21.939003 15.852996 6898.0
4800 Focsani Focsani 45.696551 27.186547 92636.5
1183 Pleven Pleven 43.423769 24.613371 110445.5
7005 Indianapolis Indianapolis 39.749988 -86.170048 1104641.5

country iso2 iso3 province
4255 Netherlands NL NLD Groningen
5171 Russia RU RUS Tambov
4204 Namibia NaN NAM Erongo
4800 Romania RO ROU Vrancea
1183 Bulgaria BG BGR Pleven
7005 United States of America US USA Indiana
```

Another common scenario of concatenating is when we have information about the columns of same dataframe split across different dataframes. Then we can use the `concat` method again to combine all the dataframes. Consider the following example.

```
In [32]: df1 = pd.DataFrame({'col1': ['col10', 'col11', 'col12', 'col13'],
...:                        'col2': ['col20', 'col21', 'col22', 'col23'],
...:                        'col3': ['col30', 'col31', 'col32', 'col33'],
...:                        'col4': ['col40', 'col41', 'col42', 'col43']},
...:                        index=[0, 1, 2, 3])
```

```

In [33]: df1
Out[33]:
   col1  col2  col3  col4
0 col10 col20 col30 col40
1 col11 col21 col31 col41
2 col12 col22 col32 col42
3 col13 col23 col33 col43

In [34]: df4 = pd.DataFrame({'col2': ['col22', 'col23', 'col26', 'col27'],
   ...:                      'Col4': ['Col42', 'Col43', 'Col46', 'Col47'],
   ...:                      'col6': ['col62', 'col63', 'col66', 'col67']},
   ...:                      index=[2, 3, 6, 7])
In [37]: pd.concat([df1,df4], axis=1)
Out[37]:
   col1  col2  col3  col4  Col4  col2  col6
0 col10 col20 col30 col40   NaN   NaN   NaN
1 col11 col21 col31 col41   NaN   NaN   NaN
2 col12 col22 col32 col42 Col42 col22 col62
3 col13 col23 col33 col43 Col43 col23 col63
6   NaN   NaN   NaN   NaN Col46 col26 col66
7   NaN   NaN   NaN   NaN Col47 col27 col67

```

## Database Style Concatenations Using the merge Command

The most familiar way to concatenate data (for those acquainted with relational databases) is using the join operation provided by the databases. Pandas provides a database friendly set of join operations for dataframes. These operations are optimized for high performance and are often the preferred method for joining disparate dataframes.

**Joining by columns:** This is the most natural way of joining two dataframes. In this method, we have two dataframes sharing a common column and we can join the two dataframes using that column. The pandas library has a full range of join operations (inner, outer, left, right, etc.) and we will demonstrate the use of inner join in this sub-section. You can easily figure out how to do the rest of join operations by checking out the pandas documentation.

For this example, we will break our original cities data into two different dataframes, one having the city information and the other having the country information. Then, we can join them using one of the shared common columns.

```

In [51]: country_data = city_data[['iso3', 'country']].drop_duplicates()
In [52]: country_data.shape
Out[52]: (223, 2)

In [53]: country_data.head()
Out[53]:
iso3  country
0  AFG  Afghanistan
33  ALD  Aland
34  ALB  Albania
60  DZA  Algeria
111  ASM  American Samoa

```

```

In [56]: del(city_data['country'])
In [59]: city_data.merge(country_data, 'inner').head()
Out[59]:
city city_ascii lat lng pop iso2 iso3 \
0 Qal eh-ye Now Qal eh-ye 34.983000 63.133300 2997 AF AFG
1 Chaghcharan Chaghcharan 34.516701 65.250001 15000 AF AFG
2 Lashkar Gah Lashkar Gah 31.582998 64.360000 201546 AF AFG
3 Zaranj Zaranj 31.112001 61.886998 49851 AF AFG
4 Tarin Kowt Tarin Kowt 32.633298 65.866699 10000 AF AFG

province country
0 Badghis Afghanistan
1 Ghor Afghanistan
2 Hilmand Afghanistan
3 Nimroz Afghanistan
4 Uruzgan Afghanistan

```

Here we had a common column in both the dataframes, `iso3`, which the merge function was able to pick up automatically. In case of the absence of such common names, we can provide the column names to join on, by using the parameter `on` of the merge function. The merge function provides a rich set of parameters that can be used to change its behavior as and when required. We will leave it on you to discover more about the merge function by trying out a few examples.

## Scikit-learn

Scikit-learn is one of the most important and indispensable Python frameworks for Data Science and Machine Learning in Python. It implements a wide range of Machine Learning algorithms covering major areas of Machine Learning like classification, clustering, regression, and so on. All the mainstream Machine Learning algorithms like support vector machines, logistic regression, random forests, K-means clustering, hierarchical clustering, and many many more, are implemented efficiently in this library. Perhaps this library forms the foundation of applied and practical Machine Learning. Besides this, its easy-to-use API and code design patterns have been widely adopted across other frameworks too!

The scikit-learn project was initiated as a Google summer of code project by David Cournapeau. The first public release of the library was in late 2010. It is one of the most active Python projects and is still under active development with new capabilities and existing enhancements being added constantly. Scikit-learn is mostly written in Python but for providing a better performance some of the core code is written in Cython. It also uses wrappers around popular implementations of learning algorithms like logistic regression (using `LIBLINEAR`) and support vector machine (using `LIBSVM`).

In our introduction of scikit-learn we will first go through the basic design principles of the library and then build on this theoretical knowledge of the package. We will implement some of the algorithms on sample data to get you acquainted with the basic syntax. We leverage scikit-learn extensively in subsequent chapters, so the intent here is to acquaint you with how the library is structured and its core components.

## Core APIs

Scikit-learn is an evolving and active project, as witnessed by its GitHub repository statistics. This framework is built on quite a small and simple list of core API ideas and design patterns. In this section we will briefly touch on the core APIs on which the central operations of scikit-learn are based.

- Dataset representation:** The data representation of most Machine Learning tasks are quite similar to each other. Very often we will have a collection of data points represented by a stacking of data point vectors. Basically considering a dataset, each row in the dataset represents a vector for a specific data point observation. A data point vector contains multiple independent variables (or features) and one or more dependent variables (response variables). For example, if we have a linear regression problem which can be represented as  $[(X_1, X_2, X_3, X_4, \dots, X_n), (Y)]$  where the independent variables (features) are represented by the  $X$ s and the dependent variable (response variable) is represented by  $Y$ . The idea is to predict  $Y$  by fitting a model on the features. This data representation resembles a matrix (considering multiple data point vectors), and a natural way to depict it is by using numpy arrays. This choice of data representation is quite simple yet powerful as we are able to access the powerful functionalities and the efficient nature of vectorized numpy array operations. In fact recent updates of scikit-learn even accept pandas dataframes as inputs instead of explicitly needing you to convert them to feature arrays!
- Estimators:** The estimator interface is one of the most important components of the scikit-learn library. All the Machine Learning algorithms in the package implement the estimator interface. The learning process is handled in a two-step process. The first step is the initialization of the estimator object; this involves selecting the appropriate class object for the algorithm and supplying the parameters or hyperparameters for it. The second step is applying the `fit` function to the data supplied (feature set and response variables). The `fit` function will learn the output parameters of the Machine Learning algorithm and expose them as public attributes of the object for easy inspection of the final model. The data to the `fit` function is generally supplied in the form of an input-output matrix pair. In addition to the Machine Learning algorithms, several data transformation mechanisms are also implemented using the estimators APIs (for example, scaling of features, PCA, etc.). This allows for simple data transformation and a simple mechanism to expose transformation mechanisms in a consistent way.
- Predictors:** The predictor interface is implemented to generate predictions, forecasts, etc. using a learned estimator for unknown data. For example, in the case of a supervised learning problem, the predictor interface will provide predicted classes for the unknown test array supplied to it. Predictor interface also contains support for providing quantified values of the output it supplies. A requirement of a predictor implementation is to provide a score function; this function will provide a scalar value for the test input provided to it which will quantify the effectiveness of the model used. Such values will be used in the future for tuning our Machine Learning models.

- **Transformers:** Transformation of input data before learning of a model is a very common task in Machine Learning. Some data transformations are simple, for example replacing some missing data with a constant, taking a log transform, while some data transformations are similar to learning algorithms themselves (for example, PCA). To simplify the task of such transformations, some estimator objects will implement the transformer interface. This interface allows us to perform a non-trivial transformation on the input data and supply the output to our actual learning algorithm. Since the transformer object will retain the estimator used for transformation, it becomes very easy to apply the same transformation to unknown test data using the `transform` function.

## Advanced APIs

In the earlier section we saw some of the most basic tenets of the `scikit-learn` package. In this section we will briefly touch on the advanced constructs that are built on those basics. These advanced set of APIs will often help data scientists in expressing a complex set of essential operations using a simple and stream-lined syntax.

- **Meta estimators:** The meta estimator interface (implemented using the multiclass interface) is a collection of estimators which can be composed by accumulating simple binary classifiers. It allows us to extend the binary classifiers to implement multi-class, multi-label, multi-regression, and multi-class-multi-label classifications. This interface is important as these scenarios are common in modern day Machine Learning and the capability to implement this out-of-the-box reduces the programming requirements for data scientists. We should also remember that most binary estimators in the `scikit-learn` library have multiclass capabilities built in and we won't be using the meta-estimators unless we need custom behavior.
- **Pipeline and feature unions:** The steps of Machine Learning are mostly sequential in nature. We will read in the data, apply some simple or complex transformations, fit an appropriate model, and predict using the model for unseen data. Another hallmark of the Machine Learning process is the iteration of these steps multiple times due to its iterative nature, to arrive at the best possible model and then deploy the same. It is convenient to chain these operations together and repeat them as a single unit instead of applying operations piecemeal. This concept is also known as Machine Learning pipelines. `Scikit-learn` provides a Pipeline API to achieve similar purpose. A `Pipeline()` object from the `pipeline` module can chain multiple estimators together (transformations, modeling, etc.) and the resultant object can be used as an estimator itself. In addition to the pipeline API, which applies these estimators in a sequential method, we also have access to a `FeatureUnion` API, which will perform a specified set of operation in parallel and show the output of all the parallel operations. The use of pipelines is a fairly advanced topic and it will be made clearer, when we specifically see an example in the subsequent chapters.

- **Model tuning and selection:** Each learning algorithm will have a bunch of parameters or hyperparameters associated with it. The iterative process of Machine Learning aims at finding the best set of parameters that give us the model having the best performance. For example, the process of tuning various hyperparameters of a random forest algorithm, to find the set which gives the best prediction accuracy (or any other performance metric). This process sometimes involves traversing through the parameter space, searching for the best parameter set. Do note that even though we mention the term parameter here, we typically indicate the hyperparameters of a model. Scikit-learn provides useful APIs that help us navigate this parameter space easily to find the best possible parameter combinations. We can use two meta-estimators—`GridSearchCV` and `RandomizedSearchCV`—for facilitating the search of the best parameters. `GridSearchCV`, as the name suggests, involves providing a grid of possible parameters and trying each possible combination among them to arrive at the best one. An optimized approach often is to use a random search through the possible parameter set; this approach is provided by the `RandomizedSearchCV` API. It samples the parameters and avoids the combinatorial explosions that can result in the case of a higher number of parameters. In addition to the parameter search, these model selection methods also allow us to use different cross-validation schemes and score functions to measure performance.

## Scikit-learn Example: Regression Models

In the first chapter, we discussed an example which involved the task of classification. In this section, we will tackle another interesting Machine Learning problem, that of regression. Keep in mind the focus here is to introduce you to the basic steps involved in using some of the `scikit-learn` library APIs. We will not try to over-engineer our solution to arrive at the best model. Future chapters will focus on those aspects with real-world datasets.

For our regression example, we will use one of the datasets bundled with the `scikit-learn` library, the diabetes dataset.

### The Dataset

The diabetes dataset is one of the bundled datasets with the `scikit-learn` library. This small dataset allows the new users of the library to learn and experiment various Machine Learning concepts, with a well-known dataset. It contains observations of 10 baseline variables, *age*, *sex*, *body mass index*, *average blood pressure*, and *six blood serum measurements* for 442 diabetes patients. The dataset bundled with the package is already standardized (scaled), i.e. they have zero mean and unit L2 norm. The response (or target variable) is a quantitative measure of disease progression one year after baseline. The dataset can be used to answer two questions:

- What is the baseline prediction of disease progression for future patients?
- Which independent variables (features) are important factors for predicting disease progression?

We will try to answer the first question here by building a simple linear regression model. Let's get started by loading the data.

```
In [60]: from sklearn import datasets
```

```
In [61]: diabetes = datasets.load_diabetes()
```

```
In [63]: y = diabetes.target
```

```
In [66]: X = diabetes.data
```

```
In [67]: X.shape
Out[67]: (442L, 10L)
```

```
In [68]: X[:5]
Out[68]:
array([[ 0.03807591,  0.05068012,  0.06169621,  0.02187235, -0.0442235 ,
        -0.03482076, -0.04340085, -0.00259226,  0.01990842, -0.01764613],
       [-0.00188202, -0.04464164, -0.05147406, -0.02632783, -0.00844872,
        -0.01916334,  0.07441156, -0.03949338, -0.06832974, -0.09220405],
       [ 0.08529891,  0.05068012,  0.04445121, -0.00567061, -0.04559945,
        -0.03419447, -0.03235593, -0.00259226,  0.00286377, -0.02593034],
       [-0.08906294, -0.04464164, -0.01159501, -0.03665645,  0.01219057,
        0.02499059, -0.03603757,  0.03430886,  0.02269202, -0.00936191],
       [ 0.00538306, -0.04464164, -0.03638469,  0.02187235,  0.00393485,
        0.01559614,  0.00814208, -0.00259226, -0.03199144, -0.04664087])
```

```
In [69]: y[:10]
Out[69]: array([ 151.,  75., 141., 206., 135.,  97., 138.,  63., 110., 310.])
```

Since we are using the data in the form of numpy arrays, we don't get the name of the features in the data itself. But we will keep the reference to the variable names as they may be needed later in our process or just for future reference.

```
In [78]: feature_names=['age', 'sex', 'bmi', 'bp',
...:                  's1', 's2', 's3', 's4', 's5', 's6']
```

For prediction of the response variable here, we will learn a Lasso model. A Lasso model is an extension of the normal linear regression model which allows us to apply L1 regularization to the model. Simply put, a lasso regression will try to minimize the number of independent variables in the final model. This will give us the model with the most important variables only (feature selection).

```
In [2]: from sklearn import datasets
...: from sklearn.linear_model import Lasso
...: import numpy as np
...: from sklearn import linear_model, datasets
...: from sklearn.model_selection import GridSearchCV
```

We will split our data into separate test and train sets of data (train is used to train the model and test is used for model performance testing and evaluation).

```
In [3]: diabetes = datasets.load_diabetes()
...: X_train = diabetes.data[:310]
...: y_train = diabetes.target[:310]
...:
...: X_test = diabetes.data[310:]
...: y_test = diabetes.data[310:]
```



Then we will define the model we want to use and the parameter space for one of the model's hyperparameters. Here we will search the parameter `alpha` of the Lasso model. This parameter basically controls the strictness our regularization.

```
In [4]: lasso = Lasso(random_state=0)
...: alphas = np.logspace(-4, -0.5, 30)
```

Then we will initialize an estimator that will identify the model to be used. Here we notice that the process is identical for both learning a single model and a grid search of models, i.e. they both are objects of the estimator class.

```
In [9]: estimator = GridSearchCV(lasso, dict(alpha=alphas))
```

```
In [10]: estimator.fit(X_train, y_train)
```

```
Out[10]:
```

```
GridSearchCV(cv=None, error_score='raise',
             estimator=Lasso(alpha=1.0, copy_X=True, fit_intercept=True, max_iter=1000,
                             normalize=False, positive=False, precompute=False, random_state=0,
                             selection='cyclic', tol=0.0001, warm_start=False),
             fit_params={}, iid=True, n_jobs=1,
             param_grid={'alpha': array([ 1.00000e-04, 1.32035e-04, 1.74333e-04, 2.30181e-04,
                                           3.03920e-04, ..., 2.39503e-01, 3.16228e-01])},
             pre_dispatch='2*n_jobs', refit=True, return_train_score=True, scoring=None,
             verbose=0)
```

This will take our train set and learn a group of Lasso models by varying the value of the `alpha` hyperparameter. The `GridSearchCV` object will also score the models that we are learning and we can use the `best_estimator_` attribute to identify the model and the optimal value of the hyperparameter that gave us the best score. Also we can directly use the same object for predicting with the best model on unknown data.

```
In [12]: estimator.best_score_
```

```
Out[12]: 0.46540637590235312
```

```
In [13]: estimator.best_estimator_
```

```
Out[13]:
```

```
Lasso(alpha=0.025929437974046669, copy_X=True, fit_intercept=True, max_iter=1000,
      normalize=False, positive=False, precompute=False, random_state=0, selection='cyclic',
      tol=0.0001, warm_start=False)
```

```
In [18]: estimator.predict(X_test)
```

```
Out[18]:
```

```
array([ 203.42104984, 177.6595529 , 122.62188598, 212.81136958, 173.61633075, 114.76145025,
        202.36033584, 171.70767813, 164.28694562, 191.29091477, 191.41279009, 288.2772433,
        296.47009002, 234.53378413, 210.61427168, 228.62812055, ...])
```

The next steps involve reiterating the whole process making changes to the data transformation, Machine Learning algorithm, tuning hyperparameters of the algorithm etc., but the basic steps will remain the same. We will go into the elaborate details of these processes in future chapters of the book. Here we will conclude our introduction to the `scikit-learn` framework and encourage you to check out their extensive documentation at <http://scikit-learn.org/stable>, which points to the home page of the most current stable version of `scikit-learn`.

## Neural Networks and Deep Learning

Deep learning has become one of the most well-known representations of Machine Learning in the recent years. Deep Learning applications have achieved remarkable accuracy and popularity in various fields especially in image and audio related domains. Python is the language of choice when it comes to learning deep networks and complex representations of data. In this section, we briefly discuss ANNs (Artificial Neural Networks) and Deep Learning networks. Then we will move on to the popular Deep Learning frameworks for Python. Since, the mathematics involved behind ANNs is quite advanced we will keep our introduction minimal and focused on the practical aspects of learning a neural network. We recommend you check out some standard literature on the theoretical aspects of Deep Learning and neural networks like *Deep Learning* by Goodfellow and Bengio, if you are more interested in its internal implementations. The following section gives a brief refresher on neural networks and Deep Learning based on what we covered in detail in Chapter 1.

### Artificial Neural Networks

Deep learning can be considered as an extension of Artificial Neural Networks (ANNs). Neural networks were first introduced as a method of learning by Frank Rosenblatt in 1958, although the learning model called perceptron was different from modern day neural networks, we can still regard the perceptron as the first artificial neural network.

Artificial neural networks loosely work on the principle of learning a distributed distribution of data. The underlying assumption is that the generated data is a result of nonlinear combination of a set of latent factors and if we are able to learn this distributed representation then we can make accurate predictions about a new set of unknown data. The simplest neural network will have an input layer, a hidden layer (a result of applying a nonlinear transformation to the input data), and an output layer. The parameters of the ANN model are the weights of each connection that exist in the network and sometimes a bias parameter. This simple neural network is represented as shown in Figure 2-6.

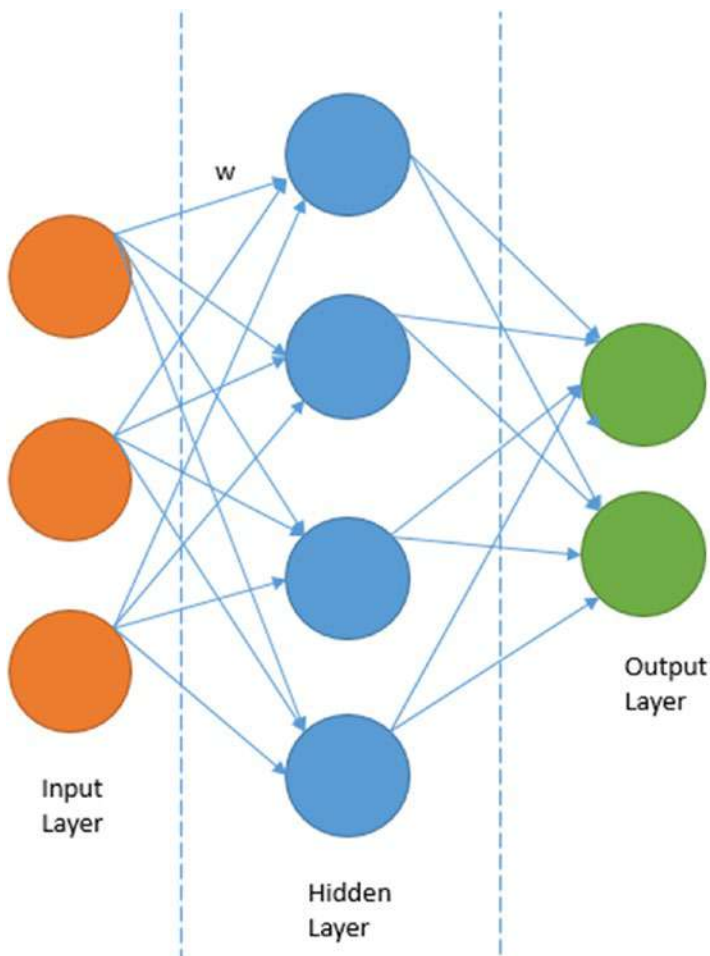

**Figure 2-6.** A simple neural network

This network is having an input vector of size 3, a hidden layer of size 4, and a binary output layer. The process of learning an ANN will involve the following steps.

1. Define the structure or architecture of the network we want to use. This is critical as if we choose a very extensive network containing a lot of neurons/units (each circle in Figure 2-6 can be labeled as neuron or a unit) then we can overfit our training data and our model won't generalize well.
2. Choose the nonlinear transformation to be applied to each connection. This transformation controls the activeness of each neuron in the network.

3. Decide on a loss function we will use for the output layer. This is applicable in the case when we have a supervised learning problem, i.e. we have an output label associated with each of the input data points.
4. Learning the parameters of the neural network, i.e. determine the values of each connection weight. Each arrow in Figure 2-6 carries a connection weight. We will learn these weights by optimizing our loss function using some optimization algorithm and a method called backpropagation.

We will not go into the details of backpropagation here, as it is beyond the scope of the present chapter. We will extend these topics when we actually use neural networks.

## Deep Neural Networks

Deep neural networks are an extension of normal artificial neural networks. There are two major differences that deep neural networks have, as compared to normal neural networks.

### Number of Layers

Normal neural networks are *shallow*, which means that they will have at max one or two hidden layers. Whereas the major difference in deep neural networks is that they have a lot more hidden layers. And this number is usually very large. For example, the Google brain project used a neural network that had millions of neurons.

### Diverse Architectures

Based on what we discussed in Chapter 1, we have a wide variety of deep neural network architectures ranging from DNNs, CNNs, RNNs, and LSTMs. Recent research have even given us attention based networks to place special emphasis on specific parts of a deep neural network. Hence with Deep Learning, we have definitely gone past the traditional ANN architecture.

### Computation Power

The larger the network and the more layers it has, the more complex the network becomes and training it takes a lot of time and resources. Deep neural networks work best on GPU based architectures and take far less time to train than on traditional CPUs, although recent improvements have vastly decreased training times.

## Python Libraries for Deep Learning

Python is a language of choice, across both academia and enterprises, to develop and use normal/deep neural networks. We will learn about two packages—*Theano* and *TensorFlow*—which will allow us to build neural network based models on datasets. In addition to these we will learn to use *Keras*, which is a high level interface to building neural networks easily and has a concise API, capable of running on top of both TensorFlow and Theano. Besides these, there are some more excellent frameworks For Deep Learning. We also recommend you to check out PyTorch, MXNet, Caffe (recently Caffe2 was released), and Lasagne.

## Theano

The first library popularly used for learning neural networks is Theano. Although by itself, Theano is not a traditional Machine Learning or a neural network learning framework, what it provides is a powerful set of constructs that can be used to train both normal Machine Learning models and neural networks. Theano allows us to symbolically define mathematical functions and automatically derive their gradient expression. This is one of the frequently used steps in learning any Machine Learning model. Using Theano, we can express our learning process with normal symbolic expressions and then Theano can generate optimized functions that carry out those steps.

Training of Machine Learning models is a computationally intensive process. Especially neural networks have steep computational requirements due to both the number of learning steps involved and the non-linearity involved in them. This problem is increased manifold when we decide to learn a deep neural network. One of the important reasons of Theano being important for neural network learning is due to its capability to generate code which executes seamlessly on both CPUs and GPUs. Thus if we specify our Machine Learning models using Theano, we are also able to get the speed advantage offered by modern day GPUs.

In the rest of this section, we see how we can install Theano and learn a very simple neural network using the expressions provided by Theano.

## Installation

Theano can be easily installed by using the Python package manager `pip` or `conda`.

```
pip install theano
```

Often the `pip` installer fails on Windows, hence we recommend using `conda install theano` on the Windows platform. We can verify the installation by importing our newly installed package in a Python shell.

```
In [1]: import theano
```

If you get no errors, then this indicates you have successfully installed the `theano` library in your system.

## Theano Basics (Barebones Version)

In this section, we discuss some basics of the symbolic abilities offered by `theano` and how those can be leveraged to build some simple learning models. We will not directly use `theano` to build a neural network in this section, but you will know how to carry out symbolic operations in `theano`. Besides this, you will see in the coming section that building neural networks is much easier when we use a higher level library such as `keras`.

Theano expresses symbolical expressions using something called *tensors*. A tensor in its simplest definition is a multi-dimensional array. So a zero-order tensor array is a scalar, a one-order tensor is a vector, and a two-order tensor is a matrix.

Now we look at how we can work on a zero-order tensor or a scalar by using constructs provided by `theano`.

```
In [3]: import numpy
...: import theano.tensor as T
...: from theano import function
...: x = T.dscalar('x')
...: y = T.dscalar('y')
...: z = x + y
...: f = function([x, y], z)
...: f(8, 2)
```

```
Out[3]: array(10.0)
```

Here, we defined a symbolical operation (denoted by the symbol  $z$ ) and then bound the input and the operations in a function. This was achieved by using the function construct provided by theano. Contrast it with the normal programming paradigm and we would need to define the whole function by ourselves. This is one of the most powerful aspects of using a symbolical mathematical package like theano. Using construct similar to these, we can define a complex set of operations.

**Graph structure:** Theano represents symbolical mathematical operations as graphs. So when we define an operation like  $z$ , as depicted in the earlier example, no calculation happens instead what we get is a graph representation of the expression. These graphs are made up of *Apply*, *Op*, and *variable* nodes. The *Apply* node represents application of some *op* on some set of *variable* nodes. So if we wanted to visualize the operation we defined in the preceding step as a graph, it would look like the depiction in Figure 2-7. (Source: <http://deeplearning.net/software/theano/extending/graphstructures.html>.)

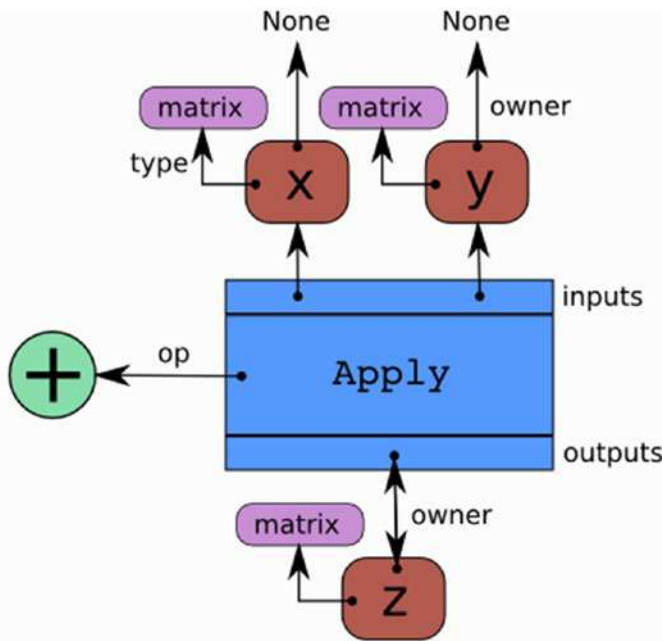

Arrows represent references to the Python objects pointed at. The blue box is an *Apply* node. Red boxes are *Variable* nodes. Green circles are *Ops*. Purple boxes are *Types*.

**Figure 2-7.** Graph structure of Theano operation

Theano has various low-level tensor APIs for building neural network architectures using Tensor arithmetic and Ops. This is available in the `theano.tensor.nnet` module and you can check out relevant functions at <http://deeplearning.net/software/theano/library/tensor/nnet/index.html>, which include `conv` for convolutional neural networks and `nnet` for regular neural network operations. This concludes our basic introduction to theano. We kept it simple because we will rarely be using theano directly and instead rely on high-level libraries like keras to build powerful deep neural networks with minimal code and focus more on solving problems efficiently and effectively.

## Tensorflow

Tensorflow is an open source software library for Machine Learning released by Google in November 2015. Tensorflow is based on the internal system that Google uses to power its research and production systems. Tensorflow is quite similar to Theano and can be considered as Google's attempt to provide an upgrade to Theano by providing easy-to-use interfaces into Deep Learning, neural networks, and Machine Learning with a strong focus on rapid prototyping and model deployment constructs. Like Theano it also provides constructs for symbolical mathematics, which are then translated into computational graphs. These graphs are then compiled into lower-level code and executed efficiently. Like theano, tensorflow also supports CPUs and GPUs seamlessly. In fact tensorflow works best on a TPU, known as the Tensor Processing Unit, which was invented by Google. In addition to having a Python API, tensorflow is also exposed by APIs to C++, Haskell, Java, and Go languages. One of the major differences tensorflow has as compared to theano is the support for higher-level operations, which ease the process of Machine Learning and its focus on model development as well as deployment to production and model serving via multiple mechanisms ([https://www.tensorflow.org/serving/serving\\_basic](https://www.tensorflow.org/serving/serving_basic)). Also the documentation and usage of theano is not so intuitive to use, which is another area tensorflow aims to fill, by its easy-to-understand implementations and extensive documentation.

The constructs provided by tensorflow are quite similar to those of Theano so we will not be reiterating those. You can always refer to the documentation provided for tensorflow at <https://www.tensorflow.org/> for more details.

## Installation

Tensorflow works well on Linux and Mac systems, but was not directly available on Windows due to internal dependencies on Bazel. The good news is that it was recently successfully launched for Windows platforms too. It requires a minimum of Python 3.5 for its execution. The library can be installed by using pip or by using conda install function. Note that for successful installation of Tensorflow, we will also require updated dask and pandas libraries on our system.

```
conda install tensorflow
```

Once we have installed the library, we can verify a successful install by verifying it in the ipython console with the following commands.

```
In [21]: import tensorflow as tf
...: hello = tf.constant('Hello, TensorFlow!')
...: sess = tf.Session()
...: print(sess.run(hello))
```

<A bunch of warning messages>

```
b'Hello, TensorFlow!'
```

The message verifies our successful install of the tensorflow library. You are also likely to see a bunch of warning messages but you can safely ignore them. The reason for those messages is the fact that the default tensorflow build is not built with support for some instruction sets, which may slow down the process of learning a bit.

## Keras

Keras is a high-level Deep Learning framework for Python, which is capable of running on top of both Theano and Tensorflow. Developed by Francois Chollet, the most important advantage of using Keras is the time saved by its easy-to-use but powerful high level APIs that enable rapid prototyping for an idea. Keras allows us to use the constructs offered by Tensorflow and Theano in a much more intuitive and easy-to-use way without writing excess boilerplate code for building neural network based models. This ease of flexibility and simplicity is the major reason for popularity of keras. In addition to providing an easy access to both of these somewhat esoteric libraries, keras ensures that we are still able to take the advantages that these libraries offer. In this section, you learn how to install Keras, learn about the basics of model development using Keras, and then learn how to develop an example neural network model using keras and tensorflow.

## Installation

Keras is easy to install using the familiar pip or conda command. We will assume that we have both tensorflow and theano installed, as they will be required to be used as backend for keras model development.

```
conda install keras
```

We can check for the successful installation of keras in our environment by importing it in IPython. Upon a successful import it will display the current backend, which is usually theano by default. So you need to go to the `keras.json` file, available under the `.keras` directory under your user account directory. Our config file contents are as follows.

```
{"epsilon": 1e-07, "floatx": "float32",
"backend": "tensorflow", "image_data_format": "channels_last"}
```

You can refer to <https://keras.io/backend/>, which tells you how easily you can switch the backend in keras from theano to tensorflow. Once the backend is specified in the config file, on importing keras, you should see the following message in your ipython shell.

```
In [22]: import keras
Using TensorFlow backend
```

## Keras Basics

The main abstraction for a neural network is a model in keras. A *model* is a collection of neurons that will define the structure of a neural network. There are two different types of models:

- **Sequential model:** Sequential models are just stacks of layers. These layers can together define a neural network. If you refer back to Figure 2-6 when we introduced neural networks, that network can be defined by specifying three layers in a sequential keras model. We will see an example of a sequential model later in this section.
- **Functional API Model:** Sequential models are very useful but sometimes our requirement will exceed the constructs possible using sequential models. This is where the function model APIs will come in to the picture. This API allows us to specify complex networks i.e., networks that can have multiple outputs, networks with shared layers, etc. These kinds of models are needed when we need to use advanced neural networks like convolutional neural networks or recurrent neural networks.



## Model Building

The model building process with `keras` is a three-step process. The first step is specifying the structure of the model. This is done by configuring the base model that we want to use, which is either a sequential model or a functional model. Once we have identified a base model for our problem we will further enrich that model by adding layers to the model. We will start with the input layer, to which we will feed our input data feature vectors. The subsequent layers to be added to the model are based on requirements of the model. `keras` provides a bunch of layers which can be added to the model (hidden layers, fully connected, CNN, LSTM, RNN, and so on), we will describe some of them while running through our neural network example. We can stack these layers together in a complex manner and add the final output layer, to arrive at our overall model architecture.

The next step in the model learning process is the compilation of the model architecture that we defined in the first step. Based on what we learned in the preceding sections on Theano and Tensorflow, most of the model building steps are symbolic and the actual learning is deferred until later. In the compilation step, we configure the learning process. The learning process, in addition to the structure of the model, needs to specify the following additional three important parameters:

- **Optimizer:** We learned in the first chapter that the simplest explanation of a learning process is the optimization of a loss function. Once we have the model and the loss function, we can specify the optimizer that will identify the actual optimization algorithm or program we will use, to train the model and minimize the loss or error. This could be a string identifier to the already implemented optimizers, a function, or an object to the `Optimizer` class that we can implement.
- **Loss function:** A loss function, also known as an objective function, will specify the objective of minimizing loss/error, which our model will leverage to get the best performance over multiple epochs/iterations. It again can be a string identifier to some pre-implemented loss functions like cross-entropy loss (classification) or mean squared error (regression) or it can be a custom loss function that we can develop.
- **Performance metrics:** A metric is a quantifiable measure of the learning process. While compiling a model, we can specify a performance metric we want to track (for example, accuracy for a classification model), which will educate us about the effectiveness of the learning process. This helps in evaluating model performance.

The last step in the model building process is executing the compiled method to start the training process. This will execute the lower level compiled code to find out the necessary parameters and weights of our model during the training process. In `keras`, like `scikit-learn`, it is achieved by calling the `fit` function on our model. We can control the behavior of the function by supplying appropriate arguments. You can learn about these arguments at <https://keras.io/models/sequential/>.

## Learning an Example Neural Network

We will conclude this section by building a simple working neural network model on one of the datasets that comes bundled with the `scikit-learn` package. We will use the `tensorflow` backend in our example, but you can try to use a `theano` backend and verify the execution of model on both the backends.

For our example, we will use the Wisconsin Breast Cancer dataset, which is bundled with the `scikit-learn` library. The dataset contains attribute drawn from a digitized image of fine needle aspirate of a breast mass. They describe characteristics of the cell nuclei present in the image. On the basis of those attributes, the mass can be marked as malignant or benign. The goal of our classification system is to predict that level. So let's get started by loading the dataset.

```
In [33]: from sklearn.datasets import load_breast_cancer
...: cancer = load_breast_cancer()
...:
...: X_train = cancer.data[:340]
...: y_train = cancer.target[:340]
...:
...: X_test = cancer.data[340:]
...: y_test = cancer.target[340:]
```

The next step of the process is to define the model architecture using the keras model class. We see that our input vector is having 30 attributes so we will have a shallow network having one hidden layer of half the units (neurons), i.e., we will have 15 units in the hidden layer. We add a one unit output layer to predict either 1 or 0 based on whether the input data point is benign or malignant. This is a simple neural network and doesn't involve Deep Learning.

```
In [39]: import numpy as np
...: from keras.models import Sequential
...: from keras.layers import Dense, Dropout
...:
```

```
In [40]: model = Sequential()
...: model.add(Dense(15, input_dim=30, activation='relu'))
...: model.add(Dense(1, activation='sigmoid'))
```

Here we have defined a sequential keras model, which is having a dense hidden layer of 15 units. The dense layer means a fully connected layer so it means that each of those 15 units (neurons) is fully connected to the 30 input features. The output layer for our example is a dense layer with the sigmoid activation. The sigmoid activation is used to convert a real valued input into a binary output (1 or 0). Once we have defined the model we will then compile the model by supplying the necessary optimizer, loss function, and the metric on which we want to evaluate the model performance.

```
In [41]: model.compile(loss='binary_crossentropy', optimizer='rmsprop', metrics=['accuracy'])
```

Here we used a loss function of `binary_crossentropy`, which is a standard loss function for binary classification problems. For the optimizer, we used `rmsprop`, which is an upgrade from the normal gradient descent algorithm. The next step is to fit the model using the `fit` function.

```
In [41]: model.fit(X_train, y_train, epochs=20, batch_size=50)
Epoch 1/20
340/340 [=====] - 0s - loss: 7.3616 - acc: 0.5382
Epoch 2/20
340/340 [=====] - 0s - loss: 7.3616 - acc: 0.5382
...
Epoch 19/20
340/340 [=====] - 0s - loss: 7.3616 - acc: 0.5382
Epoch 20/20
340/340 [=====] - 0s - loss: 7.3616 - acc: 0.5382
```

Here, the `epochs` parameter indicates one complete forward and backward pass of all the training examples. The `batch_size` parameter indicates the total number of samples which are propagated through the NN model at a time for one backward and forward pass for training the model and updating the gradient.

Thus if you have 100 observations and your batch size is 10, each epoch will consist of 10 iterations where 10 observations (data points) will be passed through the network at a time and the weights on the hidden layer units will be updated. However we can see that the overall loss and training accuracy remains the same. Which means the model isn't really learning anything from the looks of it!

The API for keras again follows the convention for scikit-learn models, hence we can use the predict function to predict for the data points in the test set. In fact we use predict\_classes to get the actual class label predicted for each test data instance.

```
In [43]: predictions = model.predict_classes(X_test)
128/229 [=====>.....] - ETA: 0s
```

Let's evaluate the model performance by looking at the test data accuracy and other performance metrics like precision, recall, and F1 score. Do not despair if you do not understand some of these terms, as we will be covering them in detail in Chapter 5. For now, you should know that scores closer to 1 indicate better results i.e., an accuracy of 1 would indicate 100% model accuracy, which is perfection. Luckily, scikit-learn provides us with necessary performance metric measuring APIs.

```
In [44]: from sklearn import metrics
...: print('Accuracy:', metrics.accuracy_score(y_true=y_test, y_pred=predictions))
...: print(metrics.classification_report(y_true=y_test, y_pred=predictions))
Accuracy: 0.759825327511
           precision    recall  f1-score   support

    0         0.00      0.00      0.00         55
    1         0.76      1.00      0.86        174

avg / total         0.58      0.76      0.66        229
```

From the previous performance metrics, we can see that even though model accuracy is 76%, for data points having cancer (malignant) i.e., label 0, it misclassifies them as 1 (55 instances) and remaining 174 instances where class label is 1 (benign), it classifies them perfectly. Thus this model hasn't learned much and predicts every response as benign (label 1). Can we do better than this?

## The Power of Deep Learning

The idea of Deep Learning is to use multiple hidden layers to learn latent and complex data patterns, relationships, and representations to build a model that learns and generalizes well on the underlying data. Let's take the previous example and convert it to a fully connected deep neural network (DNN) by introducing two more hidden layers. The following snippet builds and trains a DNN with the same configuration as our previous experiment only with the addition of two new hidden layers.

```
In [45]: model = Sequential()
...: model.add(Dense(15, input_dim=30, activation='relu'))
...: model.add(Dense(15, activation='relu'))
...: model.add(Dense(15, activation='relu'))
...: model.add(Dense(1, activation='sigmoid'))
...:
...: model.compile(loss='binary_crossentropy',
...:               optimizer='rmsprop',
...:               metrics=['accuracy'])
...:
...: model.fit(X_train, y_train,
```

```

...:         epochs=20,
...:         batch_size=50)
...:
Epoch 1/20
340/340 [=====] - 0s - loss: 3.3799 - acc: 0.3941
Epoch 2/20
340/340 [=====] - 0s - loss: 1.3740 - acc: 0.6059
Epoch 3/20
340/340 [=====] - 0s - loss: 0.4258 - acc: 0.8471
...
Epoch 19/20
340/340 [=====] - 0s - loss: 0.2361 - acc: 0.9235
Epoch 20/20
340/340 [=====] - 0s - loss: 0.3154 - acc: 0.9000

```

We see a remarkable jump in the training accuracy and a drop in the loss based on the preceding training output. This is indeed excellent and seems promising! Let's check out our model performance on the test data now.

```

In [46]: predictions = model.predict_classes(X_test)
...: print('Accuracy:', metrics.accuracy_score(y_true=y_test, y_pred=predictions))
...: print(metrics.classification_report(y_true=y_test, y_pred=predictions))
Accuracy: 0.912663755459

```

	precision	recall	f1-score	support
0	0.78	0.89	0.83	55
1	0.96	0.92	0.94	174
avg / total	0.92	0.91	0.91	229

We achieve an overall accuracy and F1 score of 91% and we can see that we also have an F1 score of 83% as compared to 0% from the previous model, for class label 0 (malignant). Thus you can clearly get a feel of the power of Deep Learning, which is evident by just introducing more hidden layers in our network, which enabled our model to learn better representations of our data. Try experimenting with other architectures or even introducing regularization aspects like dropout.

Thus, in this section, you learned about some of the important frameworks relevant to neural networks and Deep Learning. We will revisit the more advanced aspects of these frameworks in subsequent chapters when we work on real-world case studies.

## Text Analytics and Natural Language Processing

In the sections till now we have mostly dealt with structured data formats and datasets i.e., data in which we have the observations occurring as rows and the features or attributes for each of those observations occurring as columns. This format is most convenient for Machine Learning algorithms but the problem is that raw data is not always available in this easy-to-interpret format. This is the case with unstructured data formats like audio, video, textual datasets. In this section, we try to get a brief overview of the frameworks we can use to solve this problem if the data that we are working with is unstructured text data. We will not go into detailed examples of using these frameworks and if you are interested, we recommend checking out Chapter 7 of this book, which deals with a real-world case study on analyzing text data.

## The Natural Language Tool Kit

Perhaps the most important library of Python to work with text data is NLTK or the Natural Language Tool Kit. This section introduces NLTK and its important modules. We go over the installation procedure of the library and a brief description of its important modules.

### Installation and Introduction

The `nltk` package can be installed in the same way as most of the other packages used in this book, which is by using the `pip` or `conda` command.

```
conda install nltk
```

We can verify the installation by importing the package in an IPython/Python shell.

```
In [1]: import nltk
```

There's an important difference for the `nltk` library as compared to other standard libraries. In case of other libraries, in general, we don't need to download any auxiliary data. But for the `nltk` library to work to its full potential, we would require some auxiliary data, which are mostly various corpora. This data is leveraged by multiple functions and modules in the library. We can download this data by executing the following command in the Python shell.

```
In [5]: nltk.download()
```

This command will give us the screen shown in Figure 2-8, where we can select the additional data we want to install and select the installation location. We will select to install all the additional data and packages available.



**Figure 2-8.** *nltk* download option

You can also choose to download all necessary datasets without the GUI by using the following command from the `ipython` or Python shell.

```
nltk.download('all', halt_on_error=False)
```

Once the download is finished we will be able to use all the necessary functionalities and the bundled data of the `nltk` package. We will now take a look at the major modules of `nltk` library and introduce the functionality that each of them provides.

## Corpora

The starting point of any text analytics process is the process of collecting the documents of interest in a single dataset. This dataset is central to the next steps of processing and analysis. This collection of documents is generally called a *corpus*. Multiple corpus datasets are called *corpora*. The `nltk` module `nltk.corpus` provides necessary functions that can be used to read corpus files in a variety of formats. It supports the reading of corpora from the datasets bundled in `nltk` package as well as external corpora.

## Tokenization

*Tokenization* is one of the core steps in text pre-processing and normalization. Each text document has several components like paragraphs, sentences, and words that together make up the document. The process of tokenization is used to break down the document into these smaller components. This tokenization can be into sentences, words, clauses, and so on. The most popular way to tokenize any document is by using sentence tokenization and/or word tokenization. The `nltk.tokenize` module of the `nltk` library provides functionality that enables efficient tokenization of any textual data.

## Tagging

A text document is constructed based on various grammatical rules and constructs. The grammar depends on the language of the text document. Each language's grammar will contain different entities and parts of speech like nouns, pronouns, adjectives, adverbs, and so on. The process of tagging will involve getting a text corpus, tokenizing the text and assigning metadata information like tags to each word in the corpora. The `nltk.tag` module contains implementation of different algorithms that can be used for such tagging and other related activities.

## Stemming and Lemmatization

A word can have several different forms based on what part of speech it is representing. Consider the word *fly*; it can be present in various forms in the same text, like *flying*, *flies*, *flyer*, and so on. The process of stemming is used to convert all the different forms of a word in to the base form, which is known as the root step. Lemmatization is similar to stemming but the base form is known as the root word and it's always a semantically and lexicographically correct word. This conversion is crucial, as a lot of times the core word contains more information about the document, which can be diluted by these different forms. The `nltk` module `nltk.stem` contains different techniques that can be used for stemming and lemmatizing a corpus.

## Chunking

Chunking is a process which is similar to parsing or tokenization but the major difference is that instead of trying to parse each word, we will target phrases present in the document. Consider the sentence “The brown fox saw the yellow dog”. In this sentence, we have two phrases which are of interest. The first is the phrase “the brown fox,” which is a noun phrase and the second one is the phrase “the yellow dog,” which again is a noun phrase. By using the process of chunking, we are able to tag phrases with additional parts of speech information, which is important for understanding the structure of the document. The `nltk` module `nltk.chunk` consists of necessary techniques that can be used for applying the chunking process to our corpora.

## Sentiment

Sentiment or emotion analysis is one of the most recognizable applications on text data. Sentiment analysis is the process of taking a text document and trying to determine the opinion and polarity being represented by that document. Polarity in the reference of a text document can mean the emotion, e.g., positive, negative, or neutral being represented by the data. The sentiment analysis on textual data can be done using different algorithms and at different levels of text segmentation. The `nltk.sentiment` package is the module that can be used to perform different sentiment analyses on text documents. Check out Chapter 7 for a real-world case study on sentiment analysis!

## Classification/Clustering

Classification of text documents is a supervised learning problem, as we explained in the first chapter. Classification of text documents may involve learning the sentiment, topic, theme, category, and so on of several text documents (corpus) and then using the trained model to label unknown documents in the future. The major difference from normal structured data comes in the form of feature representations of unstructured text we will be using. Clustering involves grouping together similar documents based on some similarity measure, like cosine similarity, bm25 distance, or even semantic similarity. The `nltk.classify` and `nltk.cluster` modules are typically used to perform these operations once we do the necessary feature engineering and extraction.

## Other Text Analytics Frameworks

Typically, `nltk` is our go-to library for dealing with text data, but the Python ecosystem also contains other libraries that can be useful in dealing with textual data. We will briefly mention some of these libraries so that you get a good grasp of the toolkit that you can arm yourself with when dealing with unstructured textual data.

- **pattern:** The `pattern` framework is a web mining module for the Python programming language. It has tools for web mining (extracting data from Google, Twitter, a web crawler, or an HTML DOM parser), information retrieval, NLP, Machine Learning, sentiment analysis and network analysis, and visualization. Unfortunately, `pattern` currently works best on Python 2.7 and there is no official port for Python 3.x.
- **gensim:** The `gensim` framework, which stands for *generate similar*, is a Python library that has a core purpose of topic modeling at scale! This can be used to extract semantic topics from documents. The focus of `gensim` is on providing efficient topic modeling and similarity analysis. It also contains a Python implementation of Google’s popular `word2vec` model.

- **textblob:** This is another Python library that promises simplified text processing. It provides a simple API for doing common text processing tasks including parts of speech tagging, tokenization, phrase extraction, sentiment analysis, classification, translation, and much more!
- **spacy:** This is a recent addition to the Python text processing landscape but an excellent and robust framework nonetheless. The focus of `spacy` is *industrial strength natural language processing*, so it targets efficient text analytics for large-scale corpora. It achieves this efficiency by leveraging carefully memory-managed operations in Cython. We recommend using `spacy` for natural language processing and you will also see it being used extensively for our text normalization process in Chapter 7.

## Statsmodels

Statsmodels is a library for statistical and econometric analysis in Python. The advantage of languages like R is that it's a statistically focused language with lot of capabilities. It consists of easy-to-use yet powerful models that can be used for statistical analysis and modeling. However from deployment, integration, and performance aspects, data scientists and engineers often prefer Python but it doesn't have the power of easy-to-use statistical functions and libraries like R. The `statsmodels` library aims to bridge this gap for Python users. It provides the capabilities for statistical, financial and econometric operations with the aim of combining the advantages of Python with the statistical powers of languages like R. Hence users familiar with R, SAS, Stata, SPSS, and so on who might want similar functionality in Python can use `statsmodels`. The initial `statsmodel` package was developed by Jonathan Taylor, a statistician at Stanford, as part of SciPy under the name `models`. Improving this codebase was then accepted as a SciPy-focused project for the Google Summer of Code in 2009 and again in 2010. The current package is available as a SciKit or an add-on package for SciPy. We recommend you to check out the paper by Seabold, Skipper, and Josef Perktold, "Statsmodels: Econometric and statistical modeling with Python," proceedings of the 9th Python in Science Conference, 2010.

## Installation

The package can be installed using `pip` or `conda` `install` and the following commands.

```
pip install statsmodels
conda install -c conda-forge statsmodels
```

## Modules

In this section, we briefly cover the important modules that comprise the `statsmodel` package and the capability those models provides. This should give you enough idea of what to leverage to build statistical models and perform statistical analysis and inference.

## Distributions

One of the central ideas in statistics is the distributions of statistical datasets. Distributions are a listing or function that assigns a probability value to all the possible values of the data. The `distributions` module of the `statsmodels` package implements some important functions related to statistical distribution including sampling from the distribution, transformations of distributions, generating cumulative distribution functions of important distributions, and so on.



## Linear Regression

Linear regression is the simplest form of statistical modeling for modeling the relationship between a response dependent variable and one or more independent variables such that the response variable typically follows a normal distribution. The `statsmodels.regression` module allows us to learn linear models on data with IID i.e., independently and identically distributed errors. This module allows us to use different methods like ordinary least squares (OLS), weighted least squares (WLS), generalized least squares (GLS), and so on, for the estimation of the linear model parameters.

## Generalized Linear Models

Normal linear regression can be generalized if the dependent variable follows a different distribution than the normal distribution. The `statsmodels.genmod` module allows us to extend the normal linear models to different response variables. This allows us to predict the linear relationship between the independent and dependent variable when the dependent variable follows distributions other than normal distributions.

## ANOVA

Analysis of variance is a process of statistical processes used to analyze the difference between group means and associated procedures. ANOVA analysis is an important way to test whether the means of several groups are equal or unequal. This is an extremely powerful tool in hypothesis testing and statistical inference and is implemented in the `anova_lm` module of the `statsmodel` package.

## Time Series Analysis

Time series analysis is an important part of data analytics. A lot of data sources like stock prices, rainfall, population statistics, etc. are periodic in nature. Time series analysis is used find structures, trends, and patterns in these streams of data. These trends can be used to understand the underlying phenomena using a mathematical model and even make predictions and forecasts about future events. Basic time series models include univariate autoregressive models (AR), vector autoregressive models (VAR), univariate autoregressive moving average models (ARMA), as well as the very popular autoregressive integrated moving average (ARIMA) model. The `tsa` module of the `statsmodels` package provides implementation of time series models and also provides tools for time series data manipulation.

## Statistical Inference

An important part of traditional statistical inference is the process of *hypothesis testing*. A statistical hypothesis is an assumption about a population parameter. Hypothesis testing is the formal process of accepting or rejecting the assumption made about the data on the basis of observational data collected from samples taken from the population. The `stats.stattools` module of `statsmodels` package implements the most important of the hypothesis tests. Some of these tests are independent of any model, while some are tied to a particular model only.

## Nonparametric Methods

Nonparametric statistics refers to statistics that is not based on any parameterized family of probability distributions. When we make an assumption about the distribution of a random variable we assign the number of parameters required to ascertain its behavior. For example, if we say that some metric of interest follows a normal distribution it means that we can understand its behavior if we are able to determine

the *mean* and *variance* of that metric. This is the key difference in non-parametric methods, i.e., we don't have a fixed number of parameters that are required to describe an unknown random variable. Instead the number of parameters are dependent on the amount of training data. The module `nonparametric` in the `statsmodels` library will help us perform non-parametric analysis on our data. It includes kernel density estimation for univariate and multivariate data, kernel regression, and locally weighted scatterplot smoothing.

## Summary

This chapter introduced a select group of packages that we will use routinely to process, analyze, and model our data. You can consider these libraries and frameworks as the core tools of a data scientist's toolbox. The list of packages we covered is far from exhaustive but they certainly are the most important packages. We strongly suggest you get more familiar with the packages by going through their documentation and relevant tutorials. We will keep introducing and explaining other important features and aspects of these frameworks in future chapters. The examples in this chapter, along with the conceptual knowledge provided in the first chapter, should give you a good grasp toward understanding Machine Learning and solving problems in a simple and concise way. We will observe, in the subsequent chapters, that often the process of learning models on our data is a reiteration of these simple steps and concepts. In the next chapter, you learn how to wield the set of tools to solve bigger and complex problems in the areas of data processing, wrangling, and visualization.

**PART II**



# **The Machine Learning Pipeline**

## CHAPTER 3



# Processing, Wrangling, and Visualizing Data

The world around us has changed tremendously since computers and the Internet became mainstream. With the ubiquitous mobile phones and now Internet enabled devices, the line between the digital and physical worlds is more blurred than it ever was. At the heart of all this is data. Data is at the center of everything around us, be it finance, supply chains, medical science, space exploration, communication, and what not. It is not surprising that we have generated 90% of the world's data in just the last few years and this is just the beginning. Rightly, data is being termed as the *oil* of the 21st Century. The last couple of chapters introduced the concepts of Machine Learning and the Python ecosystem to get started. This chapter introduces the core entity upon which the Machine Learning world relies to show its magic and wonders.

Everything digital has data at its core in some form or the other. Data is generated at various rates by numerous sources across the globe in numerous formats. Before we dive into the specifics of Machine Learning, we will spend some time and effort understanding this central entity called data. It is important that we understand various aspects of it and get equipped with different techniques to handle it based on requirements.

In this chapter we will cover the journey data takes through a typical Machine Learning related use case where it goes from its initial raw form to a form where it can be used by Machine Learning algorithms/models to work upon. We cover various data formats, processing and wrangling techniques to get the data into a form where it can be utilized by Machine Learning algorithms for analysis. We also learn about different visualization techniques to better understand the data at hand. Together these techniques will help us be prepared for the problems to be solved in the coming chapters as well as in real-world scenarios.

Chapter 1 introduced the CRISP-DM methodology. It is one of the standard workflows followed by Data Science teams across the world. In the coming sections of this chapter, we will concentrate on the following sub-sections of this methodology:

- **Data collection:** To understand different data retrieval mechanisms for different data types
- **Data description:** To understand various attributes and properties of the data collected
- **Data wrangling:** To prepare data for consumption in the modeling steps
- **Data visualization:** To visualize different attributes for sharing results, better understanding, and so on

The code samples, jupyter notebooks, and sample datasets for this chapter are available in the GitHub repository for this book at <https://github.com/dipanjanS/practical-machine-learning-with-python> under the directory/folder for Chapter 3.

## Data Collection

*Data collection* is where it all begins. Though listed as a step that comes post *business understanding* and *problem definition*, data collection often happens in parallel. This is done in order to assist in augmenting the business understanding process with facts like availability, potential value, and so on before a complete use case can be formed and worked upon. Of course, data collection takes a formal and better form once the problem statement is defined and the project gets underway.

Data is at the center of everything around us, which is a tremendous opportunity. Yet this also presents the fact that it must be present in different formats, shapes, and sizes. Its omnipresence also means that it exists in systems such as legacy machines (say mainframes), web (say web sites and web applications), databases, flat files, sensors, mobile devices, and so on.

Let's look at some of the most commonly occurring data formats and ways of collecting such data.

### CSV

A CSV data file is one of the most widely available formats of data. It is also one of the oldest formats still used and preferred by different systems across domains. Comma Separated Values (CSV) are data files that contain data with each of its attributes delimited by a “,” (a comma). Figure 3-1 depicts a quick snapshot of how a typical CSV file looks.

The sample CSV shows how data is typically arranged. It contains attributes of different data types separated/delimited by a comma. A CSV may contain an optional header row (as shown in the example). CSVs may also optionally enclose each of the attributes in single or double quotes to better demarcate. Though usually CSVs are used to store tabular data, i.e., data in the form of rows and columns, this is not the only way.

```
sno,fruit,color,price|
1,apple,red,110.85
2,banana,yellow,50.12
3,mango,yellow,70.29
4,orange,orange,80.00
5,kiwi,green,150.00
6,pineapple,yellow,90.00
7,guava,green,20.00
```

**Figure 3-1.** Sample CSV file

CSVs come in different variations and just changing the delimiter to a tab makes one a *TSV* (or a tab separated values) file. The basic ideology here is to use a unique symbol to delimit/separate different attributes.

Now that we know how a CSV looks, let's employ some Python magic to read/extract this data for use. One of the advantages of using a language like Python is its ability to abstract and handle a whole lot of stuff. Unlike other languages where specific libraries or a lot of code is required to get basic stuff done, Python handles it with élan. Along the same lines is reading a CSV file. The simplest way to read a CSV is through the Python `csv` module. This module provides an abstraction function called the `reader()`.

The reader function takes a file object as input to return an iterator containing the information read from the csv file. The following code snippet uses the `csv.reader()` function to read a given file.

```
csv_reader = csv.reader(open(file_name, 'rb'), delimiter=',')
```

Once the iterator is returned, we can easily iterate through the contents and get the data in the form/format required. For the sake of completeness let's go through an example where we read the contents of the CSV shown in Figure 3-1 using the `csv` module. We will then extract each of its attributes and convert the data into a dict with keys representing them. The following snippet forms the actions.

```
csv_rows = list()
csv_attr_dict = dict()
csv_reader = None

# read csv
csv_reader = csv.reader(open(file_name, 'rb'), delimiter=delimiter)

# iterate and extract data
for row in csv_reader:
    print(row)
    csv_rows.append(row)

# iterate and add data to attribute lists
for row in csv_rows[1:]:
    csv_attr_dict['sno'].append(row[0])
    csv_attr_dict['fruit'].append(row[1])
    csv_attr_dict['color'].append(row[2])
    csv_attr_dict['price'].append(row[3])
```

The output is a dict containing each attribute as a key with values and as an ordered list of values read from the CSV file.

```
CSV Attributes::
{'color': ['red', 'yellow', 'yellow', 'orange', 'green', 'yellow', 'green'],
'fruit': ['apple', 'banana', 'mango', 'orange', 'kiwi', 'pineapple', 'guava'],
'price': ['110.85', '50.12', '70.29', '80.00', '150.00', '90.00', '20.00'],
'sno': ['1', '2', '3', '4', '5', '6', '7']}
```

The extraction of data from a CSV and its transformation depends on the use case requirements. The conversion of our sample CSV into a dict of attributes is one way. We may choose different output format depending on the data and our requirements.

Though the workflow to handle and read a CSV file is pretty straightforward and easy to use, we would like to standardize and speed up our process. Also, more often than not, it is easier to understand data in a tabular format. We were introduced to the `pandas` library in the previous chapter with some amazing capabilities. Let's now utilize `pandas` to read a CSV as well.

The following snippet shows how `pandas` makes reading and extracting data from a CSV that's simpler and consistent as compared to the `csv` module.

```
df = pd.read_csv(file_name, sep=delimiter)
```

With a single line and a few optional parameters (as per requirements), pandas extracts data from a CSV file into a dataframe, which is a tabular representation of the same data. One of the major advantages of using pandas is the fact that it can handle a lot of different variations in CSV files, such as files with or without headers, attribute values enclosed in quotes, inferring data types, and many more. Also, the fact that various machine learning libraries have the capability to directly work on pandas dataframes, makes it virtually a de facto standard package to handle CSV files.

The previous snippet generates the following output dataframe:

	sno	fruit	color	price
0	1	apple	red	110.85
1	2	banana	yellow	50.12
2	3	mango	yellow	70.29
3	4	orange	orange	80.00
4	5	kiwi	green	150.00
5	6	pineapple	yellow	90.00
6	7	guava	green	20.00

---

■ **Note** pandas makes the process of reading CSV files a breeze, yet the `csv` module comes in handy when we need more flexibility. For example, not every use case requires data in tabular form or the data might not be consistently formatted and requires a flexible library like `csv` to enable custom logic to handle such data.

---

Along the same lines, data from flat files containing delimiters other than `,` (comma) like tabs or semicolons can be easily handled with these two modules. We will use these utilities while working on specific use cases in further chapters; until then, you are encouraged to explore and play around with these for a better understanding.

## JSON

*Java Script Object Notation* (JSON) is one of the most widely used data interchange formats across the digital realm. JSON is a lightweight alternative to legacy formats like XML (we shall discuss this format next). JSON is a text format that is language independent with certain defined conventions. JSON is a human-readable format that is easy/simple to parse in most programming/scripting languages. A JSON file/object is simply a collection of name(key)-value pairs. Such key-value pair structures have corresponding data structures available in programming languages in the form of dictionaries (Python `dict`), `struct`, `object`, `record`, `keyed lists`, and so on. More details are available at <http://www.json.org/>.

The JSON standard defines the structure, as depicted in Figure 3-2.

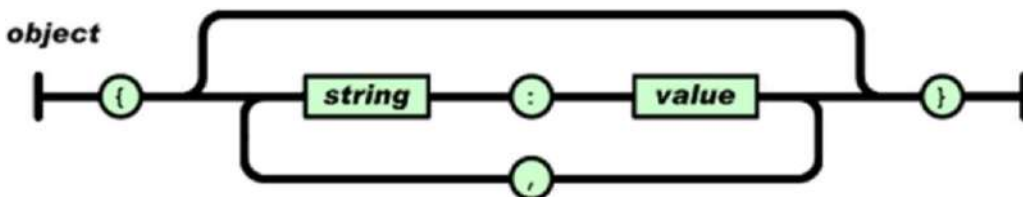

**Figure 3-2.** JSON object structure (reference: <http://www.json.org/>)

Figure 3-3 is a sample JSON depicting a record of glossary with various attributes of different data types.

```
{
  "glossary": {
    "title": "example glossary",
    "GlossDiv": {
      "title": "S",
      "GlossList": {
        "GlossEntry": {
          "ID": "SGML",
          "SortAs": "SGML",
          "GlossTerm": "Standard Generalized Markup Language",
          "Acronym": "SGML",
          "Abbrev": "ISO 8879:1986",
          "GlossDef": {
            "para": "A meta-markup language, used to create markup languages such as DocBook.",
            "GlossSeeAlso": ["GML", "XML"]
          },
          "GlossSee": "markup"
        }
      }
    }
  }
}
```

**Figure 3-3.** Sample JSON (reference: <http://www.json.org/>)

JSONs are widely used to send information across systems. The Python equivalent of a JSON object is the `dict` data type, which itself is a key-value pair structure. Python has various JSON-related libraries that provide abstractions and utility functions. The `json` library is one such option that allows us to handle JSON files/objects. Let's first take a look at our sample JSON file and then use this library to bring this data into Python for use.

```
{
  "outer_col_1": [
    {
      "nested_inner_col_1": "val_1",
      "nested_inner_col_2": 2
    },
    {
      "nested_inner_col_1": "val_2",
      "nested_inner_col_2": 2
    }
  ],
  "outer_col_2": {
    "inner_col_1": 3
  },
  "outer_col_3": 4
}
```

**Figure 3-4.** Sample JSON with nested attributes



The JSON object in Figure 3-4 depicts a fairly nested structure that contains values of string, numeric, and array type. JSON also supports objects, Booleans, and other data types as values as well. The following snippet reads the contents of the file and then utilizes `json.loads()` utility to parse and convert it into a standard Python dict.

```
json_filedata = open(file_name).read()
json_data = json.loads(json_filedata)
```

`json_data` is a Python dict with keys and values of the JSON file parsed and type casted as Python data types. The `json` library also provides utilities to write back Python dictionaries as JSON files with capabilities of error checking and typecasting. The output of the previous operation is as follows.

```
outer_col_1 :
  nested_inner_col_1 : val_1
  nested_inner_col_2 : 2
  nested_inner_col_1 : val_2
  nested_inner_col_2 : 2
outer_col_2 :
  inner_col_1 : 3
outer_col_3 : 4
```

Before we move on to our next format, it is worth noting that `pandas` also provides utilities to parse JSONs. The `pandas.read_json()` is a very powerful utility that provides multiple options to handle JSONs created in different styles. Figure 3-5 depicts a sample JSON representing multiple data points, each with two attributes listed as `col_1` and `col_2`.

```
[
  {
    "col_1": "a",
    "col_2": "b"
  },
  {
    "col_1": "c",
    "col_2": "d"
  },
  {
    "col_1": "e",
    "col_2": "f"
  },
  {
    "col_1": "g",
    "col_2": "h"
  },
  {
    "col_1": "i",
    "col_2": "j"
  },
  {
    "col_1": "k",
    "col_2": "l"
  }
]
```

**Figure 3-5.** Sample JSON depicting records with similar attributes

We can easily parse such a JSON using pandas by setting the orientation parameter to “records”, as shown here.

```
df = pd.read_json(file_name, orient="records")
```

The output is a tabular dataframe with each data point represented by two attribute values as follows.

	col_1	col_2
0	a	b
1	c	d
2	e	f
3	g	h
4	i	j
5	k	l

You are encouraged to read more about pandas `read_json()` at [https://pandas.pydata.org/pandas-docs/stable/generated/pandas.read\\_json.html](https://pandas.pydata.org/pandas-docs/stable/generated/pandas.read_json.html).

## XML

Having covered two of the most widely used data formats, so now let’s take a look at XML. XMLs are quite a dated format yet is used by a lot many systems. XML or *eXtensible Markup Language* is a markup language that defines rules for encoding data/documents to be shared across the Internet. Like JSON, XML is also a text format that is human readable. Its design goals involved strong support for various human languages (via *Unicode*), platform independence, and simplicity. XMLs are widely used for representing data of varied shapes and sizes.

XMLs are widely used as configuration formats by different systems, metadata, and data representation format for services like RSS, SOAP, and many more.

XML is a language with syntactic rules and schemas defined and refined over the years. The most import components of an XML are as follows:

- **Tag:** A markup construct denoted by strings enclosed with angled braces (“<” and “>”).
- **Content:** Any data not marked within the tag syntax is the content of the XML file/object.
- **Element:** A logical construct of an XML. An element may be defined with a start and an end tag with or without attributes, or it may be simply an empty tag.
- **Attribute:** Key-value pairs that represent the properties or attributes of the element in consideration. These are enclosed within a start or an empty tag.

Figure 3-6 is a sample XML depicting various components of the eXtensible Markup Language. More details on key concepts and details can be browsed at <https://www.w3schools.com/xml/>.

```

<?xml version="1.0"?>
- <records attr="sample xml records">
  - <record name="rec_1">
    - <sub_element>
      <detail1>Attribute 1</detail1>
      <detail2>2</detail2>
    </sub_element>
    <sub_element_with_attr attr="complex">Sub_Element_Text </sub_element_with_attr>
    <sub_element_only_attr attr_val="only_attr"/>
  </record>
  - <record name="rec_2">
    - <sub_element>
      <detail1>Attribute 1</detail1>
      <detail2>2</detail2>
    </sub_element>
    <sub_element_with_attr attr="complex">Sub_Element_Text </sub_element_with_attr>
    <sub_element_only_attr attr_val="only_attr"/>
  </record>
  - <record name="rec_3">
    - <sub_element>
      <detail1>Attribute 1</detail1>
      <detail2>2</detail2>
    </sub_element>
    <sub_element_with_attr attr="complex">Sub_Element_Text </sub_element_with_attr>
    <sub_element_only_attr attr_val="only_attr"/>
  </record>
</records>

```

**Figure 3-6.** Sample XML annotated with key components

XMLs can be viewed as tree structures, starting with one root element that branches off into various elements, each with their own attributes and further branches, the content being at leaf nodes.

Most XML parsers use this tree-like structure to read XML content. The following are the two major types of XML parsers:

- **DOM parser:** The Document Object Model parser is the closest form of tree representation of an XML. It parses the XML and generates the tree structure. One big disadvantage with DOM parsers is their instability with huge XML files.
- **SAX parser:** The Simple API for XML (or SAX for short) is a variant widely used on the web. This is an event-based parser that parses an XML element by element and provides hooks to trigger events based on tags. This overcomes the memory-based restrictions of DOM but lacks overall representation power.

There are multiple variants available that derive from these two types. To begin with, let's take a look at the `ElementTree` parser available from Python's `xml` library. The `ElementTree` parser is an optimization over the DOM parser and it utilizes Python data structures like lists and dicts to handle data in a concise manner.

The following snippet uses the `ElementTree` parser to load and parse the sample XML file we saw previously. The `parse()` function returns a tree object, which has various attributes, iterators, and utilities to extract root and further components of the parsed XML.

```
tree = ET.parse(file_name)
root = tree.getroot()

print("Root tag:{0}".format(root.tag))
print("Attributes of Root:: {0}".format(root.attrib))
```

The two print statements provide us with values related to the root tag and its attributes (if there are any). The root object also has an iterator attached to it which can be used to extract information related to all child nodes. The following snippet iterates the root object to print the contents of child nodes.

```
for child in xml:root:
    print("{0}tag:{1}, attribute:{2}".format(
        "\t"*indent_level,
        child.tag,
        child.attrib))

    print("{0}tag data:{1}".format("\t"*indent_level,
        child.text))
```

The final output generated by parsing the XML using `ElementTree` is as follows. We used a custom print utility to make the output more readable, the code for which is available on the repository.

```
Root tag:records
Attributes of Root:: {'attr': 'sample xml records'}
tag:record, attribute: {'name': 'rec_1'}
tag data:

    tag:sub_element, attribute: {}
    tag data:

        tag:detail1, attribute: {}
        tag data:Attribute 1
        tag:detail2, attribute: {}
        tag data:2
```

```

tag:sub_element_with_attr, attribute: {'attr': 'complex'}
tag data:
  Sub_Element_Text

tag:sub_element_only_attr, attribute: {'attr_val': 'only_attr'}
tag data:None
tag:record, attribute: {'name': 'rec_2'}
tag data:

tag:sub_element, attribute: {}
tag data:

    tag:detail1, attribute: {}
    tag data:Attribute 1
    tag:detail2, attribute: {}
    tag data:2
tag:sub_element_with_attr, attribute: {'attr': 'complex'}
tag data:
  Sub_Element_Text

tag:sub_element_only_attr, attribute: {'attr_val': 'only_attr'}
tag data:None

```

The `xml` library provides very useful utilities exposed through the `ElementTree` parser, yet it lacks a lot of fire power. Another Python library, `xmlltodict`, provides similar capabilities but uses Python's native data structures like dicts to provide a more Pythonic way to handle XMLs. The following is a quick snippet to parse the same XML. Unlike `ElementTree`, the `parse()` function of `xmlltodict` reads a file object and converts the contents into nested dictionaries.

```

xml_filedata = open(file_name).read()
ordered_dict = xmlltodict.parse(xml_filedata)

```

The output generated is similar to the one generated using `ElementTree` with the exception that `xmlltodict` uses the `@` symbol to mark elements and attributes automatically. The following is the sample output.

```

records :
  @attr : sample xml records
record :
  @name : rec_1
sub_element :
  detail1 : Attribute 1
  detail2 : 2
sub_element_with_attr :
  @attr : complex
  #text : Sub_Element_Text
sub_element_only_attr :
  @attr_val : only_attr

```

## HTML and Scraping

We began the chapter talking about the immense amount of information/data being generated at break-neck speeds. The Internet or the web is one of the driving forces for this revolution coupled with immense reach due to computers, smartphones and tablets.

The Internet is a huge interconnected web of information connected through hyperlinks. A large amount of data on the Internet is in the form of web pages. These web pages are generated, updated, and consumed millions of times day in and day out. With information residing in these web pages, it is imperative that we must learn how to interact and extract this information/data as well.

So far we have dealt with formats like CSV, JSON, and XML, which can be made available/extracted through various methods like manual downloads, APIs, and so on. With web pages, the methods change. In this section we will discuss the HTML format (the most common form of web page related format) and web-scraping techniques.

## HTML

The Hyper Text Markup Language (HTML) is a markup language similar to XML. HTML is mainly used by web browsers and similar applications to render web pages for consumption.

HTML defines rules and structure to describe web pages using markup. The following are standard components of an HTML page:

- **Element:** Logical constructs that form the basic building blocks of an HTML page
- **Tags:** A markup construct defined by angled braces (< and >). Some of the important tags are:
  - <html></html>: This pair of tags contains the whole of HTML document. It marks the start and end of the HTML page.
  - <body></body>: This pair of tags contains the main content of the HTML page rendered by the browser.

There are many more standard set of tags defined in the HTML standard; further information is available at [https://www.w3schools.com/html/html\\_intro.asp](https://www.w3schools.com/html/html_intro.asp).

The following is a snippet to generate an HTML page that's rendered by a web browser, as shown in the screenshot in Figure 3-7.

```
<!DOCTYPE html>
<html>
<head>
<title>Sample HTML Page</title>
</head>
<body>

<h1>Sample WebPage</h1>
<p>HTML has been rendered</p>

</body>
</html>
```



**Figure 3-7.** Sample HTML page as rendered in browser

Browsers use markup tags to understand special instructions like text formatting, positioning, hyperlinks, and so on but only renders the content for the end user to see. For use cases where data/information resides in HTML pages, we need special techniques to extract this content.

## Web Scraping

Web scraping is a technique to scrape or extract data from the web, particularly from web pages. Web scraping may involve manually copying the data or using automation to crawl, parse, and extract information from web pages. In most contexts, web scraping refers to automatically crawling a particular web site or a portion of the web to extract and parse information that can be later on used for analytics or other use cases. A typical web scraping flow can be summarized as follows:

- **Crawl:** A bot or a web crawler is designed to query a web server using the required set of URLs to fetch the web pages. A crawler may employ sophisticated techniques to fetch information from pages linked from the URLs in question and even parse information to a certain extent. Web sites maintain a file called `robots.txt` to employ what is called as the “Robots Exclusion Protocol” to restrict/provide access to their content. More details are available at <http://www.robotstxt.org/robotstxt.html>.
- **Scrape:** Once the raw web page has been fetched, the next task is to extract information from it. The task of scraping involves utilizing techniques like *regular expressions*, extraction based on *XPath*, or specific tags and so on to narrow down to the required information on the page.

Web scraping involves creativity from the point of view of narrowing down to the exact piece of information required. With web sites changing constantly and web pages becoming dynamic (see `asp`, `jsp`, etc.), presence of access controls (username/password, CAPTCHA, and so on) complicate the task even more. Python is a very powerful programming language, which should be evident by now, and scraping the web is another task for which it provides multiple utilities. Let’s begin with extracting a blog post’s text from the Apress blog to better understand web scraping.

The first task is to identify the URL we are interested in. For our current example, we concentrate on the first blog post of the day on Apress web site’s blog page at <http://www.apress.com/in/blog/all-blog-posts>. Clicking on the top most blog post takes us to the main article in consideration. The article is shown in the screen in Figure 3-8.

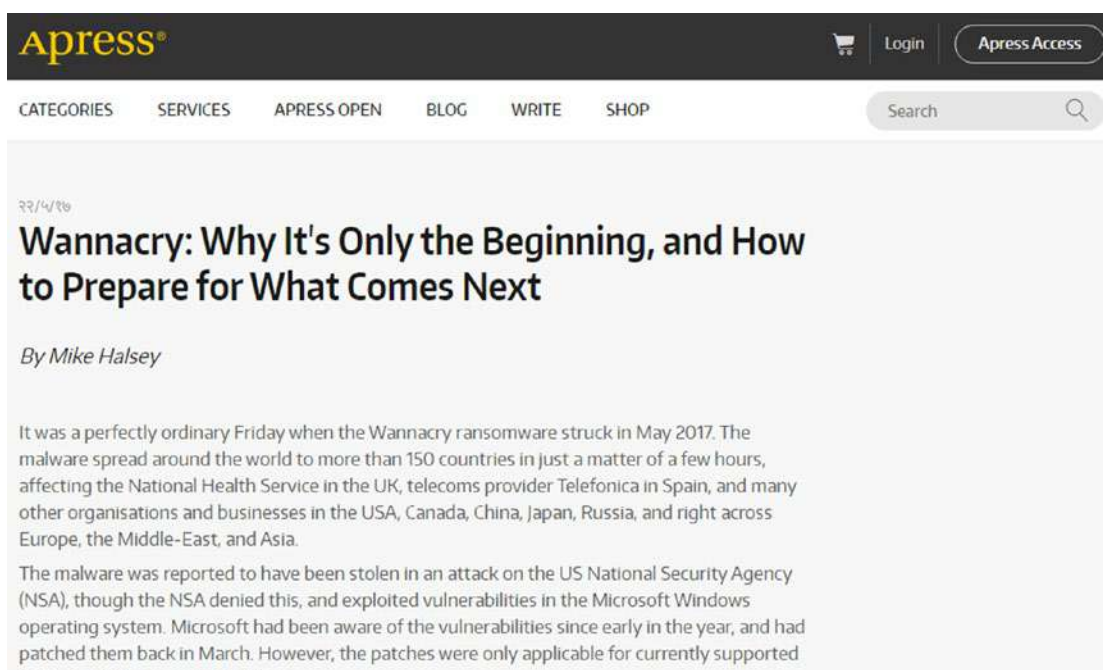

**Figure 3-8.** A blog post on Apress.com

Now that we have the required page and its URL, we will use the `requests` library to query the required URL and get a response. The following snippet does the same.

```
base_url = "http://www.apress.com/in/blog/all-blog-posts"
blog_suffix = "/wannacry-how-to-prepare/12302194"

response = requests.get(base_url+blog_suffix)
```

If the `get` request is successful, the response object's `status_code` attribute contains a value of 200 (equivalent to HTML success code). Upon getting a successful response, the next task is to devise a method to extract the required information.

Since in this case we are interested in the blog post's actual content, let's analyze the HTML behind the page and see if we can find specific tags of interest.

---

■ **Note** Most modern browsers come with HTML inspection tools built-in. If you are using Google Chrome, press F12 or right-click on the page and select `Inspect` or `View Source`. This opens the HTML code for you to analyze.

---



Figure 3-9 depicts a snapshot of the HTML behind the blog post we are interested in.

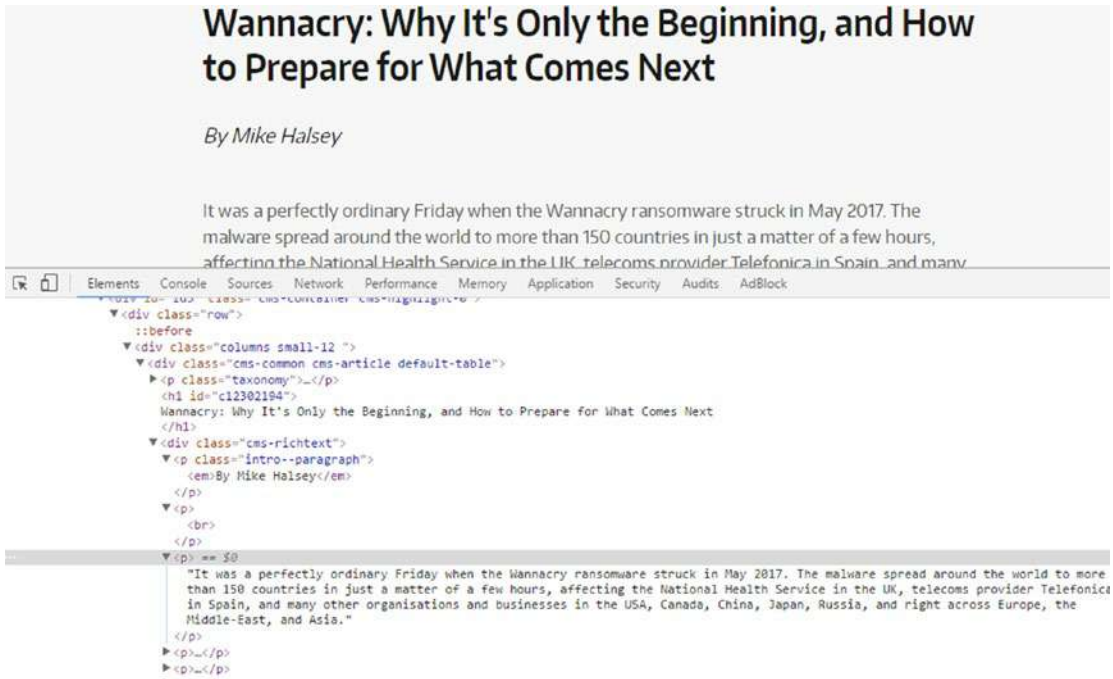

**Figure 3-9.** Inspecting the HTML content of a blog post on Apress.com

Upon careful inspection, we can clearly see text of the blog post is contained within the div tag `<div class="cms-richtext">`. Now that we have narrowed down to the tag of interest, we use Python's regular expression library `re` to search and extract data contained within these tags only. The following snippet utilizes `re.compile()` to compile a regular expression and then uses `re.findall()` to extract the information from the fetched response.

```
content_pattern = re.compile(r'<div class="cms-richtext">(.*?)</div>')
result = re.findall(content_pattern, content)
```

The output of the find operation is the required text from the blog post. Of course, it still contains HTML tags interlaced between the actual text. We can perform further clean up to reach the required levels, yet this is a good start. The following is snapshot of information extracted using regular expressions.

```
Out[59]: '<p class="intro--paragraph"><em>By Mike Halsey</em></p><p><br/></p><p>It was a perfectly ordinary Friday when the Wannacry ransomware struck in May 2017. The malware spread around the world to more than 150 countries in just a matter of a few hours, affecting the National Health Service in the UK, telecoms provider Telefonica in Spain, and many other organisations and businesses in the USA, Canada, China, Japan, Russia, and right across Europe, the Middle-East, and Asia.</p><p>The malware was reported to have been stolen in an attack on the US National Security Agency (NSA), though the NSA denied this, and exploited vulnerabilities in the Microsoft Windows operating system. Microsoft had been aware of the vulnerabilities since early in the year, and had patched them back in March.'
```

This was a straightforward and a very basic approach to get the required data. What if we want to go a step further and extract information related to all blog posts on the page and perform a better cleanup?

For such a task, we utilize the BeautifulSoup library. BeautifulSoup is the go-to standard library for web scraping and related tasks. It provides some amazing functionality to ease out the scraping process. For the task at hand, our process would be to first crawl the index page and extract the URLs to all the blog post links listed on the page. For this we would use the `requests.get()` function to extract the content and then utilize BeautifulSoup's utilities to get the content from the URLs. The following snippet showcases the function `get_post_mapping()`, which parses the home page content to extract the blog post headings and corresponding URLs into a dictionary. The function finally returns a list of such dictionaries.

```
def get_post_mapping(content):
    """This function extracts blog post title and url from response object

    Args:
        content (request.content): String content returned from requests.get

    Returns:
        list: a list of dictionaries with keys title and url

    """
    post_detail_list = []
    post_soup = BeautifulSoup(content, "lxml")
    h3_content = post_soup.find_all("h3")

    for h3 in h3_content:
        post_detail_list.append(
            {'title':h3.a.get_text(),'url':h3.a.attrs.get('href')}
        )

    return post_detail_list
```

The pervious function first creates an object of BeautifulSoup specifying lxml as its parser. It then uses the h3 tag and a regex based search to extract the required list of tags (we got to the h3 tag by the same inspect element approach we utilized previously). The next task was to simply iterate through the list of the h3 tags and utilize the `get_text()` utility function from BeautifulSoup to get the blog post heading and its corresponding URL. The list returned from the function is as follows.

```
[{'title': u"Wannacry: Why It's Only the Beginning, and How to Prepare for What Comes Next",
  'url': '/in/blog/all-blog-posts/wannacry-how-to-prepare/12302194'},
 {'title': u'Reusing ngrx/effects in Angular (communicating between reducers)',
  'url': '/in/blog/all-blog-posts/reusing-ngrx-effects-in-angular/12279358'},
 {'title': u'Interview with Tony Smith - Author and SharePoint Expert',
  'url': '/in/blog/all-blog-posts/interview-with-tony-smith-author-and-sharepoint-expert/12271238'},
 {'title': u'Making Sense of Sensors \u2013 Types and Levels of Recognition',
  'url': '/in/blog/all-blog-posts/making-sense-of-sensors/12253808'},
 {'title': u'VS 2017, .NET Core, and JavaScript Frameworks, Oh My!',
  'url': '/in/blog/all-blog-posts/vs-2017-net-core-and-javascript-frameworks-oh-my/12261706'}]
```

Now that we have the list, the final step is to iterate through this list of URLs and extract each blog post's text. The following function showcases how BeautifulSoup simplifies the task as compared to our previous method of using regular expressions. The method of identifying the required tag remains the same, though we utilize the power of this library to get text that is free from all HTML tags.

```
def get_post_content(content):
    """This function extracts blog post content from response object

    Args:
        content (request.content): String content returned from requests.get

    Returns:
        str: blog's content in plain text

    """
    plain_text = ""
    text_soup = BeautifulSoup(content, "lxml")
    para_list = text_soup.find_all("div",
                                   {'class': 'cms-richtext'})

    for p in para_list[0]:
        plain_text += p.getText()

    return plain_text
```

The following output is the content from one of the posts. Pay attention to the cleaner text in this case as compared to our previous approach.

By Mike HalseyIt was a perfectly ordinary Friday when the Wannacry ransomware struck in May 2017. The malware spread around the world to more than 150 countries in just a matter of a few hours, affecting the National Health Service in the UK, telecoms provider Telefonica in Spain, and many other organisations and businesses in the USA, Canada, China, Japan, Russia, and right across Europe, the Middle-East, and Asia. The malware was reported to have been stolen in an attack on the US National Security Agency (NSA), though the NSA denied this, and exploited vulnerabilities in the Microsoft Windows operating system. Microsoft had been aware of the vulnerabilities since early in the year, and had patched them back in March.

Through these two methods, we crawled and extracted information related to blog posts from our web site of interest. You are encouraged to experiment with other utilities from BeautifulSoup along with other web sites for a better understanding. Of course, do read the robots.txt and honor the rules set by the webmaster.

## SQL

Databases date back to the 1970s and represent a large volume of data stored in relational form. Data available in the form of tables in databases, or to be more specific, relational databases, comprise of another format of structured data that we encounter when working on different use cases. Over the years, there have been various flavors of databases available, most of them conforming to the SQL standard.

The Python ecosystem handles data from databases in two major ways. The first and the most common way used while working on data science and related use cases is to access data using SQL queries directly. To access data using SQL queries, powerful libraries like sqlalchemy and pyodbc provide convenient interfaces to connect, extract, and manipulate data from a variety of relational databases like MS SQL Server, MySQL,

Oracle, and so on. The `sqlite3` library provides a lightweight easy-to-use interface to work with SQLite databases, though the same can be handled by the other two libraries as well.

The second way of interacting with databases is the ORM or the Object Relational Mapper method. This method is synonymous to the object oriented model of data, i.e., relational data is mapped in terms of objects and classes. `SQLAlchemy` provides a high-level interface to interact with databases in the ORM fashion. We will explore more on these based on the use cases in the subsequent chapters.

## Data Description

In the previous section, we discussed various data formats and ways of extracting information from them. Each of the data formats comprised of data points with attributes of diverse types. These data types in their raw data forms form the basis of input features utilized by Machine Learning algorithms and other tasks in the overall Data Science workflow. In this section, we touch upon major data types we deal with while working on different use cases.

### Numeric

This is simplest of the data types available. It is also the type that is directly usable and understood by most algorithms (though this does not imply that we use numeric data in its raw form). Numeric data represents scalar information about entities being observed, for instance, number of visits to a web site, price of a product, weight of a person, and so on. Numeric values also form the basis of vector features, where each dimension is represented by a scalar value. The scale, range, and distribution of numeric data has an implicit effect on the algorithm and/or the overall workflow. For handling numeric data, we use techniques such as *normalization*, *binning*, *quantization*, and many more to transform numeric data as per our requirements.

### Text

Data comprising of unstructured, alphanumeric content is one of most common data types. Textual data when representing human language content contains implicit grammatical structure and meaning. This type of data requires additional care and effort for transformation and understanding. We cover aspects of transforming and using textual data in the coming chapters.

### Categorical

This data type stands in between the numeric and text. Categorical variables refer to categories of entities being observed. For instance, hair color being black, brown, blonde and red or economic status as low, medium, or high. The values may be represented as numeric or alphanumeric, which describe properties of items in consideration. Based on certain characteristics, categorical variables can be seen as:

- *Nominal*: These define only the category of the data point without any ordering possible. For instance, hair color can be black, brown, blonde, etc., but there cannot be any order to these categories.
- *Ordinal*: These define category but can also be ordered based on rules on the context. For example, people categorized by economic status of low, medium, or high can be clearly ordered/sorted in the respective order.

It is important to note that standard mathematical operations like, addition, subtraction, multiplication, etc. do not carry meaning for categorical variables even though that may be allowed syntactically (categorical variables represented as numbers). Thus it is important to handle categorical variables with care and we will see a couple of ways of handling categorical data in the coming section.

Different data types form the basis of features that are ingested by algorithms for analysis of data at hand. In the coming sections and chapters, especially Chapter 4: Feature Engineering and Selection, you will learn more on how to work with specific data types.

## Data Wrangling

So far in this chapter we discussed data formats and data types and learned about ways of collecting data from different sources. Now that we have an understanding of the initial process of collecting and understanding data, the next logical step is to be able to use it for analysis using various Machine Learning algorithms based upon the use case at hand. But before we reach the stage where this “raw” data is anywhere close to be useable for the algorithms or visualizations, we need to polish and shape it up.

*Data wrangling* or *data munging* is the process of cleaning, transforming, and mapping data from one form to another to utilize it for tasks such as analytics, summarization, reporting, visualization, and so on.

## Understanding Data

Data wrangling is one of most important and involving steps in the whole Data Science workflow. The output of this process directly impacts all downstream steps such as *exploration*, *summarization*, *visualization*, *analysis* and even the final result. This clearly shows why Data Scientists spend a lot of time in Data Collection and Wrangling. There are a lot many surveys which help in bringing this fact out that more than often, Data Scientists end up spending 80% of their time in data processing and wrangling!

So before we get started with actual use cases and algorithms in the coming chapters, it is imperative that we understand and learn how to wrangle our data and transform it into a useable form. To begin with, let's first describe the dataset at hand. For the sake of simplicity, we prepare a sample dataset describing product purchase transactions by certain users. Since we already discussed ways of collecting/extracting data, we will skip that step for this section. Figure 3-10 shows a snapshot of dataset.

	Date	Price	Product ID	Quantity Purchased	Serial No	User ID	User Type
0	NaN	3021.06	417	13	1000	5958	NaN
1	NaN	1822.62	731	1	1001	5351	c
2	2016-07-01	542.36	829	2	1002	5799	a
3	2016-01-20	2323.30	905	0	1003	5480	d
4	2016-01-19	243.43	158	37	1004	5790	a
5	2016-01-16	274.26	754	33	1005	5820	a
6	NaN	5836.68	341	18	1006	5468	c
7	2016-01-19	NaN	819	34	1007	5486	b
8	2016-01-23	1171.88	929	12	1008	5143	a
9	2016-07-01	668.80	718	31	1009	5510	d

**Figure 3-10.** Sample dataset

---

■ **Note** The dataset in consideration has been generated using standard Python libraries like `random`, `datetime`, `numpy`, `pandas`, and so on. This dataset has been generated using a utility function called `generate_sample_data()` available in the code repository for this book. The data has been randomly generated and is for representational purposes only.

---

The dataset describes transactions having the following attributes/features/properties:

- **Date:** The date of the transaction
- **Price:** The price of the product purchased
- **Product ID:** Product identification number
- **Quantity Purchased:** The quantity of product purchased in this transaction
- **Serial No:** The transaction serial number
- **User ID:** Identification number for user performing the transaction
- **User Type:** The type of user

Let's now begin our wrangling/munging process and understand various methods/tricks to clean, transform, and map our dataset to bring it into a useable form. The first and the foremost step usually is to get a quick peak into the number of records/rows, the number of columns/attributes, column/attribute names, and their data types.

For the majority of this section and subsequent ones, we will be relying on `pandas` and its utilities to perform the required tasks. The following snippet provides the details on row counts, attribute counts, and details.

```
print("Number of rows::",df.shape[0])
print("Number of columns::",df.shape[1] )

print("Column Names::",df.columns.values.tolist())

print("Column Data Types::\n",df.dtypes)
```

The required information is available straight from the `pandas` dataframe itself. The `shape` attribute is a two-value tuple representing the row count and column count, respectively. The column names are available through the `columns` attributes, while the `dtypes` attribute provides us with the data type of each of the columns in the dataset. The following is the output generated by this snippet.

```
Number of rows:: 1001
Number of columns:: 7

Column Names:: ['Date', 'Price', 'Product ID', 'Quantity Purchased', 'Serial No', 'User ID',
'User Type']

Column Data Types::
Date          object
Price         float64
```

```

Product ID           int32
Quantity Purchased  int32
Serial No           int32
User ID             int32
User Type           object
dtype: object

```

The column names are clearly listed and have been explained previously. Upon inspecting the data types, we can clearly see that the Date attribute is represented as an object. Before we move on to transformations and cleanup, let's dig in further and collect more information to understand and prepare a strategy of required tasks for dataset wrangling. The following snippet helps get information related to attributes/columns containing missing values, count of rows, and indices that have missing values in them.

```

print("Columns with Missing Values::",df.columns[df.isnull().any()].tolist())

print("Number of rows with Missing Values::",len(pd.isnull(df).any(1).nonzero()[0].tolist()))

print("Sample Indices with missing data::",pd.isnull(df).any(1).nonzero()[0].tolist()[0:5] )

```

With pandas, subscripting works with both rows and columns (see Chapter 2 for details). We use `isnull()` to identify columns containing missing values. The utilities `any()` and `nonzero()` provide nice abstractions to identify any row/column conforming to a condition (in this case pointing to rows/columns having missing values). The output is as follows.

```

Columns with Missing Values:: ['Date', 'Price', 'User Type']
Number of rows with Missing Values:: 61
Sample Indices with missing data:: [0L, 1L, 6L, 7L, 10L]

```

Let's also do a quick fact checking to get details on non-null rows for each column and the amount of memory consumed by this dataframe. We also get some basic summary statistics like min, max, and so on; these will be useful in coming tasks. For the first task, we use the `info()` utility while the summary statistics are provided by the `describe()` function. The following snippet does this.

```

print("General Stats::")
print(df.info())

print("Summary Stats::" )
print(df.describe())

```

The following is the output generated using the `info()` and `describe()` utilities. It shows Date and Price both have about 970 non-null rows, while the dataset consumes close to 40KB of memory. The summary stats are self-explanatory and drop the non-numeric columns like Date and User Type from the output.

```

General Stats::
<class 'pandas.core.frame.DataFrame'>
RangeIndex: 1001 entries, 0 to 1000
Data columns (total 7 columns):
Date           970 non-null object
Price          970 non-null float64
Product ID     1001 non-null int32
Quantity Purchased  1001 non-null int32

```

```

Serial No          1001 non-null int32
User ID           1001 non-null int32
User Type         1000 non-null object
dtypes: float64(1), int32(4), object(2)
memory usage: 39.2+ KB
None

```

Summary Stats::

	Price	Product ID	Quantity Purchased	Serial No	User ID
count	970.000000	1001.000000	1001.000000	1001.000000	1001.000000
mean	1523.906402	600.236763	20.020979	1452.528472	5335.669331
std	1130.331869	308.072110	11.911782	386.505376	994.777199
min	2.830000	0.000000	0.000000	-1.000000	-101.000000
25%	651.622500	342.000000	10.000000	1223.000000	5236.000000
50%	1330.925000	635.000000	20.000000	1480.000000	5496.000000
75%	2203.897500	875.000000	30.000000	1745.000000	5726.000000
max	5840.370000	1099.000000	41.000000	2000.000000	6001.000000

## Filtering Data

We have completed our first pass of the dataset at hand and understood what it has and what is missing. The next stage is about cleanup. Cleaning a dataset involves tasks such as removing/handling incorrect or missing data, handling outliers, and so on. Cleaning also involves standardizing attribute column names to make them more readable, intuitive, and conforming to certain standards for everyone involved to understand. To perform this task, we write a small function and utilize the `rename()` utility of pandas to complete this step. The `rename()` function takes a dict with keys representing the old column names while values point to newer ones. We can also decide to modify the existing dataframe or generate a new one by setting the `inplace` flag appropriately. The following snippet showcases this function.

```

def cleanup_column_names(df, rename_dict={}, do_inplace=True):
    """This function renames columns of a pandas dataframe
       It converts column names to snake case if rename_dict is not passed.
    Args:
        rename_dict (dict): keys represent old column names and values point to
                           newer ones
        do_inplace (bool): flag to update existing dataframe or return a new one
    Returns:
        pandas dataframe if do_inplace is set to False, None otherwise
    """
    if not rename_dict:
        return df.rename(columns={col: col.lower().replace(' ', '_')}
                        for col in df.columns.values.tolist()),
                        inplace=do_inplace)
    else:
        return df.rename(columns=rename_dict, inplace=do_inplace)

```

Upon using this function on our dataframe in consideration, the output in Figure 3-11 is generated. Since we do not pass any dict with old and new column names, the function updates all columns to snake case.



	date	price	product_id	quantity_purchased	serial_no	user_id	user_type
0	NaN	3021.06	417	13	1000	5958	NaN
1	NaN	1822.62	731	1	1001	5351	c
2	2016-07-01	542.36	829	2	1002	5799	a
3	2016-01-20	2323.30	905	0	1003	5480	d
4	2016-01-19	243.43	158	37	1004	5790	a

**Figure 3-11.** Dataset with columns renamed

For different algorithms, analysis and even visualizations, we often require only a subset of attributes to work with. With pandas, we can vertically slice (select a subset of columns) in a variety of ways. pandas provides different ways to suit different scenarios as we shall see in the following snippet.

```
print("Using Column Index::" )
print(df[[3]].values[:, 0] )

print("Using Column Name::" )
print(df.quantity_purchased.values)

print("Using Column Data Type::" )
print(df.select_dtypes(include=['float64']).values[:,0] )
```

In this snippet, we have performed attribute selection in three different ways. The first method utilizes column index number to get the required information. In this case, we wanted to work with only the field `quantity_purchased`, hence index number 3 (pandas columns are 0 indexed). The second method also extracts data for the same attribute by directly referring to the column name in dot notation. While the first method is very handy when working in loops, the second one is more readable and blends well when we are utilizing the object oriented nature on Python. Yet there are times when we would need to get attributes based on their data types alone. The third method makes use of `select_dtypes()` utility to get this job done. It provides ways of both including and excluding columns based on data types alone. In this example we selected the column(s) with data type as float (price column in our dataset). The output from this snippet is as follows.

```
Using Column Index::
[13  1  2 ...,  2 30 17]

Using Column Name::
[13  1  2 ...,  2 30 17]

Using Column Data Type::
[ 3021.06  1822.62  542.36 ..., 1768.66  1848.5  1712.22]
```

Selecting specific attributes/columns is one of the ways of subsetting a dataframe. There may be requirements to horizontally splitting a dataframe as well. To work with a subset of rows, pandas provides ways as outlined in the following snippet.

```
print("Select Specific row indices::")
print(df.iloc[[10,501,20]] )

print(Excluding Specific Row indices::" )
print(df.drop([0,24,51], axis=0).head())

print("Subsetting based on logical condition(s)::" )
print(df[df.quantity_purchased>25].head())

print("Subsetting based on offset from top (bottom)::" )
print(df[100:].head() #df.tail(-100) )
```

The first method utilizes the `iloc` (or integer index/location) based selection, we need to specify a list of indices we need from the dataframe. The second method allows in removing/filtering out specific row indices from the dataframe itself. This comes in handy in scenarios where rows not satisfying certain criteria need to be filtered out. The third method showcases conditional logic based filtering of rows. The final method filters based on offset from the top of the dataframe. A similar method, called `tail()`, can be used to offset from bottom as well. The output generated is depicted in Figure 3-12.

Subsetting based on logical condition(s)::

	date	price	product_id	quantity_purchased	serial_no	user_id	user_type
4	2016-01-19	243.43	158	37	1004	5790	a
5	2016-01-16	274.26	754	33	1005	5820	a
7	2016-01-19	NaN	819	34	1007	5486	b
9	2016-07-01	668.80	718	31	1009	5510	d
10	NaN	653.34	649	27	1010	5563	d

Subsetting based on offset from top (bottom)::

	date	price	product_id	quantity_purchased	serial_no	user_id	user_type
100	2016-01-30	1031.37	456	19	1100	5095	d
101	2016-01-17	1860.96	150	27	1101	5492	b
102	2016-01-20	609.15	842	14	1102	5601	d
103	2016-01-20	2572.66	561	21	1103	-101	a
104	NaN	1507.27	595	31	1104	5392	b

**Figure 3-12.** Different ways of subsetting rows

## Typecasting

Typecasting or converting data into appropriate data types, is an important part of cleanup and wrangling in general. Often data gets converted into wrong data types while being extracted or converted from one form to the other. Also different platforms and systems handle each data type differently and thus getting the right data type is important. While starting the wrangling discussion, we checked upon the data types of all the columns of our dataset. If you remember, the date column was marked as an object. Though it may not be an issue if we are not going to work with dates, but in cases we need date and related attributes, having them as objects/strings can pose problems. Moreover, it is difficult to handle date operations if they are available as strings. To fix our dataframe, we use `to_datetime()` function from pandas. This is a very flexible utility that allows us to set different attributes like date time formats, timezone, and so on. Since in our case, the values are just dates, we use the function as follows with defaults.

```
df['date'] = pd.to_datetime(df.date)
print(df.dtypes)
```

Similarly, we can convert numeric columns marked as strings using `to_numeric()` along with direct Python style typecasting as well. Upon checking the data types now, we clearly see the date column in the correct data type of `datetime64`.

```
date                datetime64[ns]
price               float64
product_id          int32
quantity_purchased int32
serial_no           int32
user_id             int32
user_type           object
dtype: object
```

## Transformations

Another common task with data wrangling is to transform existing columns or derive new attributes based on requirements of the use case or data itself. To derive or transform column, pandas provide three different utilities—`apply()`, `applymap()`, and `map()`. The `apply()` function is used to perform actions on the whole object, depending upon the axis (default is on all rows). The `applymap()` and `map()` functions work element-wise with `map()` coming from the `pandas.Series` hierarchy.

As an example to understand these three utilities, let's derive some new attributes. First, let's expand the `user_type` attribute using the `map()` function. We write a small function to map each of the distinct `user_type` codes into their corresponding user classes as follows.

```
def expand_user_type(u_type):
    if u_type in ['a','b']:
        return 'new'
    elif u_type == 'c':
        return 'existing'
    elif u_type == 'd':
        return 'loyal_existing'
    else:
        return 'error'
```

```
df['user_class'] = df['user_type'].map(expand_user_type)
```

Along the same lines, we use the `applymap()` function to perform another element-wise operation to get the week of the transaction from the date attribute. For this case, we use the lambda function to get the job done quickly. Refer to previous chapters for more details on lambda functions. The following snippet gets us the week for each of the transactions.

```
df['purchase_week'] = df[['date']].applymap(lambda dt:dt.week
                                           if not pd.isnull(dt.week)
                                           else 0)
```

Figure 3-13 depicts our dataframe with two additional attributes—`user_class` and `purchase_week`.

	date	price	product_id	quantity_purchased	serial_no	user_id	user_type	user_class	purchase_week
0	NaT	1075.89	1023	14	1000	5067	NaN	error	0
1	2016-01-18	158.82	503	33	1001	5654	a	new	3
2	2016-10-01	587.60	0	32	1002	5554	d	loyal_existing	39
3	2016-01-31	21.58	831	40	1003	5951	d	loyal_existing	4
4	NaT	1630.22	245	35	1004	5755	d	loyal_existing	0

**Figure 3-13.** Dataframe with derived attributes using `map` and `applymap`

Let's now use the `apply()` function to perform action on the whole of the dataframe object itself. The following snippet uses the `apply()` function to get range (maximum value to minimum value) for all numeric attributes. We use the previously discussed `select_dtypes` and lambda function to complete the task.

```
df.select_dtypes(include=[np.number]).apply(lambda x: x.max()- x.min())
```

The output is a reduced pandas .Series object showcasing range values for each of the numeric columns.

```
price                5837.54
product_id           1099.00
quantity_purchased   41.00
serial_no            2001.00
user_id              6102.00
purchase_week        53.00
```

## Imputing Missing Values

Missing values can lead to all sorts of problems when dealing with Machine Learning and Data Science related use cases. Not only can they cause problems for algorithms, they can mess up calculations and even final outcomes. Missing values also pose risk of being interpreted in non-standard ways as well leading to confusion and more errors. Hence, imputing missing values carries a lot of weight in the overall data wrangling process.

One of the easiest ways of handling missing values is to ignore or remove them altogether from the dataset. When the dataset is fairly large and we have enough samples of various types required, this option can be safely exercised. We use the `dropna()` function from pandas in the following snippet to remove rows of data where the date of transaction is missing.

```
print("Drop Rows with missing dates:")
df_dropped = df.dropna(subset=['date'])
print("Shape:",df_dropped.shape)
```

The result is a dataframe with rows without any missing dates. The output dataframe is depicted in Figure 3-14.

```
Drop Rows with missing dates::
Shape:: (970, 9)
```

	date	price	product_id	quantity_purchased	serial_no	user_id	user_type	user_class	purchase_week
1	2016-01-18	158.82	503	33	1001	5654	a	new	3
2	2016-10-01	587.60	0	32	1002	5554	d	loyal_existing	39
3	2016-01-31	21.58	831	40	1003	5951	d	loyal_existing	4
6	2016-05-02	245.64	461	12	1006	5065	a	new	18
11	2016-01-02	1762.14	345	37	1011	5972	a	new	53

**Figure 3-14.** Dataframe without any missing date information

Often dropping rows is a very expensive and unfeasible option. In many scenarios, missing values are imputed using the help of other values in the dataframe. One commonly used trick is to replace missing values with a central tendency measure like mean or median. One may also choose other sophisticated measures/statistics as well. In our dataset, the price column seems to have some missing data. We utilize the `fillna()` method from pandas to fill these values with mean price value from our dataframe.

On the same lines, we use the `ffill()` and `bfill()` functions to impute missing values for the `user_type` attribute. Since, `user_type` is a string type attribute, we use a proximity based solution to handle missing values in this case. The `ffill()` and `bfill()` functions copy forward the data from the previous row (forward fill) or copy the value from the next row (backward fill). The following snippet showcases the three functions.

```
print("Fill Missing Price values with mean price::" )
df_dropped['price'].fillna(value=np.round(df.price.mean(),decimals=2),
                           inplace=True)

print("Fill Missing user_type values with value from \
      previous row (forward fill) ::" )
df_dropped['user_type'].fillna(method='ffill',inplace=True)

print("Fill Missing user_type values with value from \
      next row (backward fill) ::" )
df_dropped['user_type'].fillna(method='bfill',inplace=True)
```

Apart from these ways, there are certain conditions where a record is not much of use if it has more than a certain threshold of attribute values missing. For instance, if in our dataset a transaction has less than three attributes as non-null, the transaction might almost be unusable. In such a scenario, it might be advisable to drop that data point itself. We can filter out such data points using the function `dropna()` with the parameter `thresh` set to the threshold of non-null attributes. More details are available on the official documentation page.

## Handling Duplicates

Another issue with many datasets is the presence of duplicates. While data is important and more the merrier, duplicates do not add much value per se. Even more, duplicates help us identify potential areas of errors in recording/collecting the data itself. To identify duplicates, we have a utility called `df.duplicated()` that can be applied on the whole dataframe as well as on a subset of it. We may handle duplicates by fixing the errors and use the `df.duplicated()` function, although we may also choose to drop the duplicate data points altogether. To drop duplicates, we use the method `df.drop_duplicates()`. The following snippet showcases both functions discussed here.

```
df_dropped[df_dropped.duplicated(subset=['serial_no'])]

df_dropped.drop_duplicates(subset=['serial_no'],inplace=True)
```

The output of identifying a subset of a dataframe having duplicate values for the field `serial_no` is depicted in Figure 3-15. The second line in the previous snippet simply drops those duplicates.

	date	price	product_id	quantity_purchased	serial_no	user_id	user_type	user_class	purchase_week
41	2016-08-01	2774.02	388	40	-1	5848	a	new	31
60	2016-12-01	1202.85	728	17	-1	5504	a	new	48
102	2016-01-16	173.71	725	1	-1	5404	c	existing	2
107	2016-01-25	1618.98	540	32	-1	6000	a	new	4
118	2016-01-16	1291.09	742	35	-1	5130	a	new	2

**Figure 3-15.** Dataframe with duplicate `serial_no` values

## Handling Categorical Data

As discussed in the section “Data Description,” categorical attributes consist of data that can take a limited number of values (not always though). Here in our dataset, the attribute `user_type` is a categorical variable that can take only a limited number of values from the allowed set {a,b,c,d}. The algorithms that we would be learning and utilizing in the coming chapters mostly work with numerical data and categorical variables may pose some issues. With pandas, we can handle categorical variables in a couple of different ways. The first one is using the `df.map()` function, where we simply map each value from the allowed set to a numeric value. Though this may be useful, this approach should be handled with care and caveats. For instance, statistical operations like addition, mean, and so on, though syntactically valid, should be avoided for obvious reasons (more on this in coming chapters). The second method is to convert the categorical variable into indicator variables using the `df.get_dummies()` function. The function is simply a wrapper to generate *one hot encoding* for the variable in consideration. One hot encoding and other encodings can be handled using libraries like `sklearn` as well (we will see more examples in coming chapters).

The following snippet showcases both the methods discussed previously using `df.map()` and `df.get_dummies()`.

```
# using map to dummy encode
type_map={'a':0,'b':1,'c':2,'d':3,np.NaN:-1}
df['encoded_user_type'] = df.user_type.map(type_map)
print(df.head())

# using get_dummies to one hot encode
print(pd.get_dummies(df,columns=['user_type']).head())
```

The output is generated as depicted in Figure 3-16 and Figure 3-17. Figure 3-16 shows the output of dummy encoding. With the `map()` approach we keep the number of features in check, yet have to be careful about the caveats mentioned in this section.

	date	price	product_id	quantity_purchased	serial_no	user_id	user_type	user_class	purchase_week	encoded_user_type
0	NaN	1075.89	1023	14	1000	5067	NaN	error	0	-1
1	2016-01-18	158.82	503	33	1001	5654	a	new	3	0
2	2016-10-01	587.60	0	32	1002	5554	d	loyal_existing	39	3
3	2016-01-31	21.58	831	40	1003	5951	d	loyal_existing	4	3
4	NaN	1630.22	245	35	1004	5755	d	loyal_existing	0	3

**Figure 3-16.** Dataframe with `user_type` attribute dummy encoded

The second image, Figure 3-17, showcases the output of one hot encoding the `user_type` attribute. We discuss more these approaches in detail in Chapter 4, when we discuss feature engineering.

user_id	user_class	purchase_week	user_type_a	user_type_b	user_type_c	user_type_d
5067	error	0	0.0	0.0	0.0	0.0
5654	new	3	1.0	0.0	0.0	0.0
5554	loyal_existing	39	0.0	0.0	0.0	1.0
5951	loyal_existing	4	0.0	0.0	0.0	1.0
5755	loyal_existing	0	0.0	0.0	0.0	1.0

**Figure 3-17.** Dataframe with `user_type` attribute one hot encoded

## Normalizing Values

Attribute normalization is the process of standardizing the range of values of attributes. Machine learning algorithms in many cases utilize distance metrics, attributes or features of different scales/ranges which might adversely affect the calculations or bias the outcomes. Normalization is also called feature scaling. There are various ways of scaling/normalizing features, some of them are rescaling, standardization (or zero-mean unit variance), unit scaling and many more. We may choose a normalization technique based upon the feature, algorithm and use case at hand. This will be clearer when we work on use cases. We also cover feature scaling strategies in detail in Chapter 4: Feature Engineering and Selection. The following snippet showcases a quick example of using a min-max scaler, available from the preprocessing module of `sklearn`, which rescales attributes to the desired given range.

```
df_normalized = df.dropna().copy()
min_max_scaler = preprocessing.MinMaxScaler()
np_scaled = min_max_scaler.fit_transform(df_normalized['price'].reshape(-1,1))
df_normalized['normalized_price'] = np_scaled.reshape(-1,1)
```

Figure 3-18 showcases the unscaled price values and the normalized price values that have been scaled to a range of `[0, 1]`.

	price	normalized_price
2	1312.22	0.217750
5	706.62	0.116814
7	760.75	0.125835
9	2445.60	0.406652
10	1862.96	0.309543

**Figure 3-18.** Original and normalized values for price

## String Manipulations

Raw data presents all sorts of issues and complexities before it can be used for analysis. Strings are another class of raw data which needs special attention and treatment before our algorithms can make sense out of them. As mentioned while discussing wrangling methods for categorical data, there are limitations and issues while directly using string data in algorithms.

String data representing natural language is highly noisy and requires its own set of steps for wrangling. Though most of these steps are use case dependent, it is worth mentioning them here (we will cover these in detail along with use cases for better clarity). String data usually undergoes wrangling steps such as:

- **Tokenization:** Splitting of string data into constituent units. For example, splitting sentences into words or words into characters.
- **Stemming and lemmatization:** These are normalization methods to bring words into their root or canonical forms. While stemming is a heuristic process to achieve the root form, lemmatization utilizes rules of grammar and vocabulary to derive the root.
- **Stopword Removal:** Text contains words that occur at high frequency yet do not convey much information (punctuations, conjunctions, and so on). These words/phrases are usually removed to reduce dimensionality and noise from data.

Apart from the three common steps mentioned previously, there are other manipulations like POS tagging, hashing, indexing, and so on. Each of these are required and tuned based on the data and problem statement on hand. Stay tuned for more details on these in the coming chapters.

## Data Summarization

Data summarization refers to the process of preparing a compact representation of raw data at hand. This process involves aggregation of data using different statistical, mathematical, and other methods. Summarization is helpful for visualization, compressing raw data, and better understanding of its attributes.

The pandas library provides various powerful summarization techniques to suit different requirements. We will cover a couple of them here as well. The most widely used form of summarization is to group values based on certain conditions or attributes. The following snippet illustrates one such summarization.

```
print(df['price'][df['user_type']=='a'].mean())
print(df['purchase_week'].value_counts())
```



The first statement calculates the mean price for all transactions by `user_type`, while the second one counts the number of transactions per week. Though these calculations are helpful, grouping data based on attributes helps us get a better understanding of it. The `groupby()` function helps us perform the same, as shown in the following snippet.

```
print(df.groupby(['user_class'])['quantity_purchased'].sum())
```

This statement generates a tabular output representing sum of quantities purchased by each `user_class`. The output is generated as follows.

```
user_class
existing      4830
loyal_existing  5515
new          10100
Name: quantity_purchased, dtype: int32
```

The `groupby()` function is a powerful interface that allows us to perform complex groupings and aggregations. In the previous example we grouped only on a single attribute and performed a single aggregation (i.e., `sum`). With `groupby()` we can perform multi-attribute groupings and apply multiple aggregations across attributes. The following snippet showcases three variants of `groupby()` usage and their corresponding outputs.

```
# variant-1: multiple aggregations on single attribute
df.groupby(['user_class'])['quantity_purchased'].agg([np.sum, np.mean,
                                                       np.count_nonzero])

# variant-2: different aggregation functions for each attribute
df.groupby(['user_class', 'user_type']).agg({'price': np.mean,
                                             'quantity_purchased': np.max})

# variant-3
df.groupby(['user_class', 'user_type']).agg({'price': {'total_price': np.sum,
                                                       'mean_price': np.mean,
                                                       'variance_price': np.std,
                                                       'count': np.count_nonzero},
                                             'quantity_purchased': np.sum})
```

The three different variants can be explained as follows.

**Variant 1:** Here we apply three different aggregations on quantity purchased which is grouped by `user_class` (see Figure 3-19).

	sum	mean	count_nonzero
user_class			
existing	4830	20.466102	236
loyal_existing	5515	20.811321	265
new	10100	21.581197	468

**Figure 3-19.** *Groupby with multiple aggregations on single attribute*

**Variant 2:** Here, we apply different aggregation functions on two different attributes. The `agg()` function takes a dictionary as input containing attributes as keys and aggregation functions as values (see Figure 3-20).

		price	quantity_purchased
user_class	user_type		
existing	c	2242.485042	41
loyal_existing	d	2277.297887	41
new	a	2246.811982	41
	b	2292.995104	41

**Figure 3-20.** Groupby with different aggregation functions for different attributes

**Variant 3:** Here, we do a combination of variants 1 and 2, i.e., we apply multiple aggregations on the price field while applying only a single one on quantity\_purchased. Again a dictionary is passed, as shown in the snippet. The output is shown in Figure 3-21.

		price				quantity_purchased
		count	total_price	mean_price	variance_price	sum
user_class	user_type					
existing	c	236.0	529226.47	2242.485042	1458.283022	4830
loyal_existing	d	265.0	603483.94	2277.297887	1565.646118	5515
new	a	227.0	510026.32	2246.811982	1538.380005	4891
	b	241.0	552611.82	2292.995104	1563.058020	5209

**Figure 3-21.** Groupby with showcasing a complex operation

Apart from `groupby()` based summarization, other functions such as `pivot()`, `pivot_table()`, `stack()`, `unstack()`, `crosstab()`, and `melt()` provide capabilities to reshape the pandas dataframe as per requirements. A complete description of these methods with examples is available as part of pandas documentation at <https://pandas.pydata.org/pandas-docs/stable/reshaping.html>. We encourage you to go through the same.

## Data Visualization

Data Science is a type of storytelling that involves data as its lead character. As Data Science practitioners we work with loads of data which undergo processing, wrangling, and analysis day in and day out for various use cases. Augmenting this storytelling with visual aspects like charts, graphs, maps and so on not just helps in improving the understanding of data (and in turn the use case/business problem) but also provides opportunities to find hidden patterns and potential insights.

Data visualization is thus the process of visually representing information in the form of charts, graphs, pictures, and so on for a better and universally consistent understanding.

We mention universally consistent understanding to point out a very common issue with human languages. Human languages are inherently complex and depending upon the intentions and skills of the writer, the audience may perceive the written information in different ways (causing all sorts of problems). Presenting data visually thus provides us with a consistent language to present and understand information (though this as well is not free from misinterpretation yet it provides certain consistency).

In this section, we begin by utilizing pandas and its capabilities to visually understand data through different visualizations. We will then introduce visualizations from the matplotlib perspective.

---

■ **Note** Data visualization in itself is a popular and deep field of study utilized across domains. This chapter and section only presents a few topics to get us started. This is by no means a comprehensive and detailed guide on data visualization. Interested readers may explore further, though topics covered here and in coming chapters should be enough for most common tasks related to visualizations.

---

## Visualizing with Pandas

Data visualization is a diverse field and a science on its own. Though the selection of the type of visualization highly depends on the data, the audience, and more, we will continue with our product transaction dataset from the previous section to understand and visualize.

Just as a quick recap, the dataset at hand consisted of transactions indicating purchase of products by certain users. Each transaction had the following attributes.

- **Date:** The date of the transaction
- **Price:** The price of the product purchased
- **Product ID:** Product identification number
- **Quantity Purchased:** The quantity of product purchased in this transaction
- **Serial No:** The transaction serial number
- **User ID:** Identification number of user performing the transaction
- **User Type:** The type of user

We wrangle our dataset to clean up the column names, convert attributes to correct data types, and derive additional attributes of `user_class` and `purchase_week`, as discussed in the previous section.

pandas is a very popular and powerful library, examples of which we have been seeing throughout the chapter. Visualization is another important and widely used feature of pandas. It exposes its visualization capabilities through the plot interface and closely follows matplotlib style visualization syntax.

## Line Charts

We begin with first looking at the purchase patterns of a user who has a maximum number of transactions (we leave this as an exercise for you to identify such a user). A trend is best visualized using the line chart. Simply subsetting the dataframe on the required fields, the `plot()` interface charts out a line chart by default. The following snippet shows the price-wise trend for the given user.

```
df[df.user_id == max_user_id][['price']].plot(style='blue')
plt.title('Price Trends for Particular User')
```

The `plt` alias is for `matplotlib.pyplot`. We will discuss this more in the coming section, for now assume we require this to add-on enhancements to plots generated by pandas. In this case we use it to add a title to our plot. The plot generated is depicted in Figure 3-22.

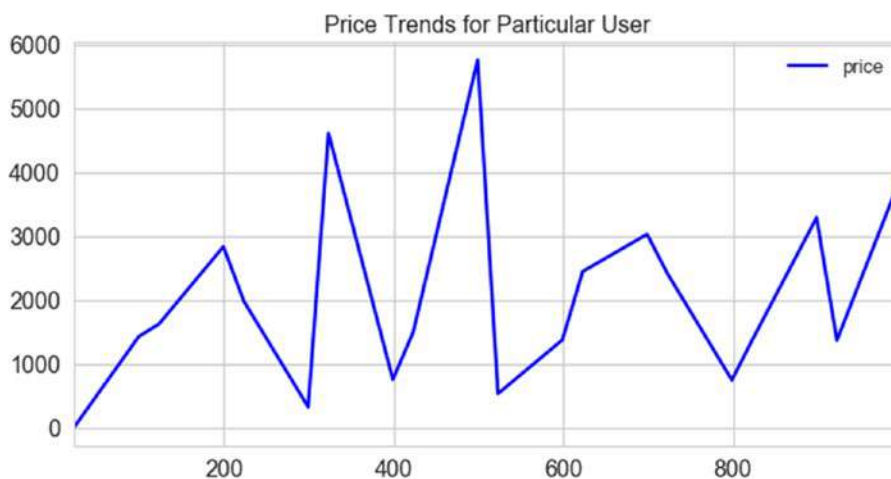

**Figure 3-22.** Line chart showing price trend for a user

Though we can see a visual representation of prices of different transactions by this user, it is not helping us much. Let's now use the line chart again to understand how his/her purchase trends over time (remember we have date of transactions available in the dataset). We use the same plot interface by subsetting the dataframe to the two required attributes. The following code snippet outlines the process.

```
df[df.user_id == max_user_id].plot(x='date',y='price',style='blue')
plt.title('Price Trends for Particular User Over Time')
```

This time, since we have two attributes, we inform pandas to use the date as our x-axis and price as the y-axis. The plot interface handles `datetime` data types with élan as is evident in the following output depicted in Figure 3-23.



**Figure 3-23.** Price trend over time for a given user

This time our visualization clearly helps us see the purchase pattern for this user. Though we can discuss about insights from this visualization at length, a quick inference is clearly visible. As the plot shows, the user seems to have purchased high valued items in the starting of the year, with a decreasing trend as the year has progressed. Also, the number of transactions in the beginning of the year are more and closer as compared to rest of the year. We can correlate such details with more data to identify patterns and behaviors. We shall cover more such aspects in coming chapters.

## Bar Plots

Having seen trends for a particular user, let's take a look at our dataset at an aggregated level. Since we already have a derived attribute called the `purchase_week`, let's use it to aggregate quantities purchased by users over time. We first aggregate the data at a week level using the `groupby()` function and then aggregate the attribute `quantity_purchased`. The final step is to plot the aggregation on a bar plot. The following snippet helps us plot this information.

```
df[['purchase_week',
    'quantity_purchased']].groupby('purchase_week').sum().plot.barh(
    color='orange')
plt.title('Quantities Purchased per Week')
```

We use the `barh()` function to prepare a horizontal bar chart. It is similar to a standard `bar()` plot in terms of the way it represents information. The difference is in the orientation of the plots. Figure 3-24 shows the generated output.

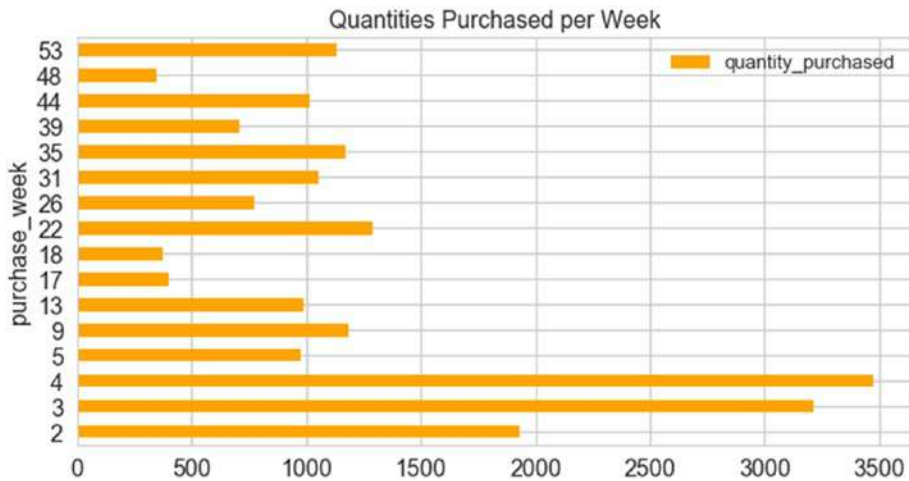

**Figure 3-24.** Bar plot representing quantities purchased at a weekly level

## Histograms

One of the most important aspects of exploratory data analysis (EDA) is to understand distribution of various numerical attributes of a given dataset. The simplest and the most common way of visualizing a distribution is through histograms. We plot the price distribution of the products purchased in our dataset as shown in the following snippet.

```
df.price.hist(color='green')
plt.title('Price Distribution')
```

We use the `hist()` function to plot the price distribution in a single line of code. The output is depicted in Figure 3-25.



**Figure 3-25.** Histogram representing price distribution

The output shown in Figure 3-25 clearly shows a skewed and tailed distribution. This information will be useful while using such attributes in our algorithms. More will be clear when we work on actual use cases.

We can take this a step further and try to visualize the price distribution on a per week basis. We do so by using the parameter `by` in the `hist()` function. This parameter helps us group data based on the attribute mentioned, as `by` and then generates a subplot for each such grouping. In our case, we group by purchase week as shown in the following snippet.

```
df[['price', 'purchase_week']].hist(by='purchase_week' ,sharex=True)
```

The output depicted in Figure 3-26 showcases distribution of price on a weekly basis with the highest bin clearly marked in a different color.

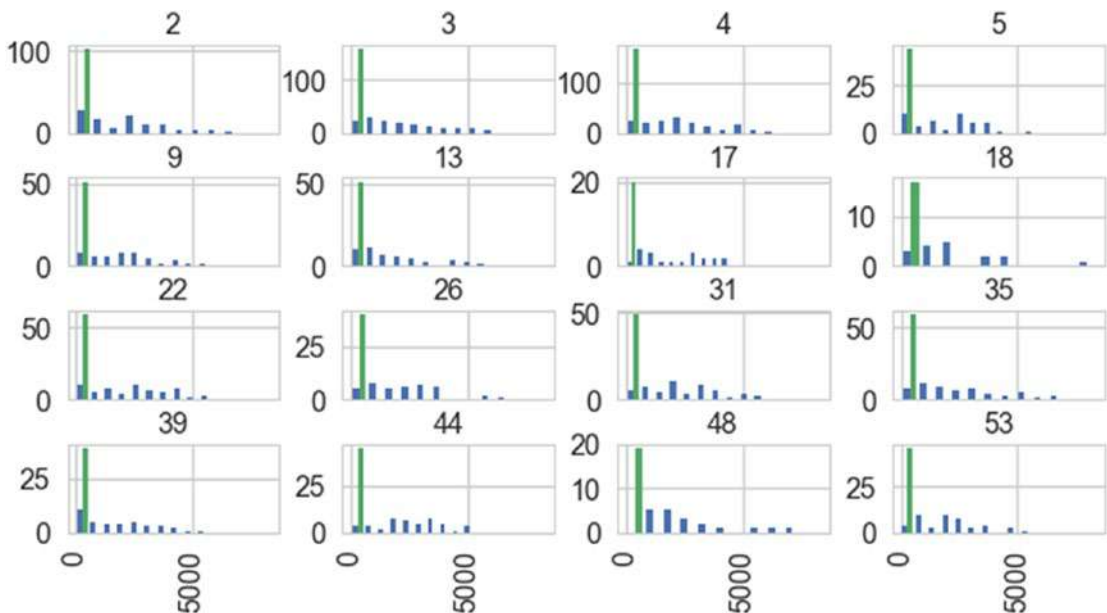

**Figure 3-26.** Histograms on a weekly basis

## Pie Charts

One of the most commonly sought after questions while understanding the data or extracting insights is to know which type is contributing the most. To visualize percentage distribution, pie charts are best utilized. For our dataset, the following snippet helps us visualize which user type purchased how much.

```
class_series = df.groupby('user_class').size()
class_series.name = 'User Class Distribution'
class_series.plot.pie(autopct='%0.2f')
plt.title('User Class Share')
plt.show()
```

The previous snippet uses `groupby()` to extract a series representing number of transactions on a per `user_class` level. We then use the `pie()` function to plot the percentage distribution. We use the `autopct` parameter to annotate the plot with actual percentage contribution by each `use_class`. Figure 3-27 depicts the output pie chart.

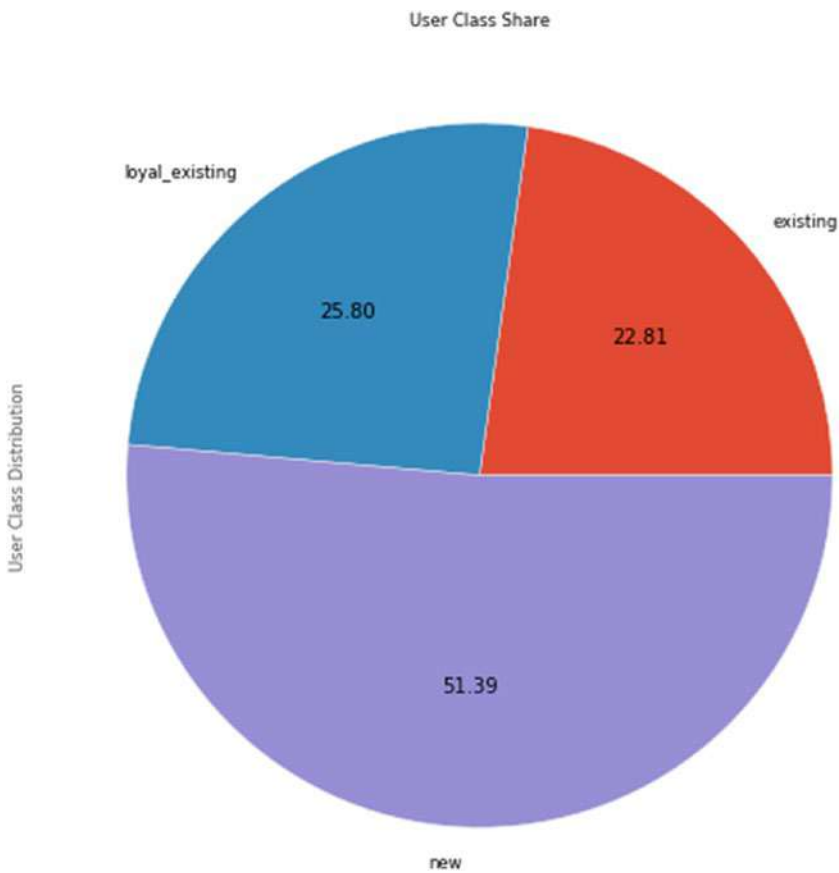

**Figure 3-27.** Pie chart representing user class transaction distribution

The plot in Figure 3-27 clearly points out that new users are having more than 50% of the total transaction share while existing and `loyal_existing` ones complete the remaining. We do not recommend using pie charts especially when you have more than three or four categories. Use bar charts instead.

## Box Plots

Box plots are important visualizations that help us understand quartile distribution of numerical data. A box plot or box-whisker plot is a concise representation to help understand different quartiles, skewness, dispersion, and outliers in the data.



We'll look at the attributes `quantity_purchased` and `purchase_week` using box plots. The following snippet generates the required plot for us.

```
df[['quantity_purchased', 'purchase_week']].plot.box()
plt.title('Quantity and Week value distribution')
```

Now, we'll look at the plots generated (see Figure 3-28). The bottom edge of the box in box plot marks the first quartile, while the top one marks the third. The line in the middle of the box marks the second quartile or the median. The top and bottom whiskers extending from the box mark the range of values. Outliers are marked beyond the whisker boundaries. In our example, for quantity purchased, the median is quite close to the middle of the box while the purchase week has it toward the bottom (clearly pointing out the skewness in the data). You are encouraged to read more about box plots for an in-depth understanding at <http://www.physics.csbsju.edu/stats/box2.html>, <http://www.stat.yale.edu/Courses/1997-98/101/boxplot.htm>.



**Figure 3-28.** Box plots using pandas

## Scatter Plots

Scatter plots are another class of visualizations usually used to identify correlations or patterns between attributes. Like most visualization we have seen so far, scatter plots are also available through the `plot()` interface of pandas.

To understand scatter plots, we first need to perform a couple of steps of data wrangling to get our data into required shape. We first encode the `user_class` with dummy encoding (as discussed in the previous section) using `map()` and then getting mean price and count of transactions on a per week per `user_class` level using `groupby()`. The following snippet helps us get our dataframe.

```
uclass_map = {'new': 1, 'existing': 2, 'loyal_existing': 3, 'error': 0}
df['enc_uclass'] = df.user_class.map(uclass_map)
```

```

bubble_df = df[['enc_uclass',
                'purchase_week',
                'price', 'product_id']].groupby(['purchase_week',
                                                'enc_uclass']).agg(
    {'price': 'mean',
     'product_id': 'count'})
    .reset_index()

bubble_df.rename(columns={'product_id': 'total_transactions'}, inplace=True)

```

	purchase_week	enc_uclass	price	total_transactions
0	2	1	2380.846349	63
1	2	2	1984.570645	31
2	2	3	2167.079286	28
3	3	1	2620.948333	84
4	3	2	2757.447632	38
5	3	3	2394.359250	40
6	4	1	2347.251364	88
7	4	2	2315.305185	27
8	4	3	2322.400213	47
9	5	1	2384.101333	30

**Figure 3-29.** Dataframe aggregated on a per week per user\_class level

Figure 3-29 showcases the resultant dataframe. Now, let's visualize this data using a scatter plot. The following snippet does the job for us.

```

bubble_df.plot.scatter(x='purchase_week',
                      y='price')
plt.title('Purchase Week Vs Price ')
plt.show()

```

This generates the plot in Figure 3-30 showcasing an almost random spread of data across weeks and average price with some slight concentration in the top left of the plot.

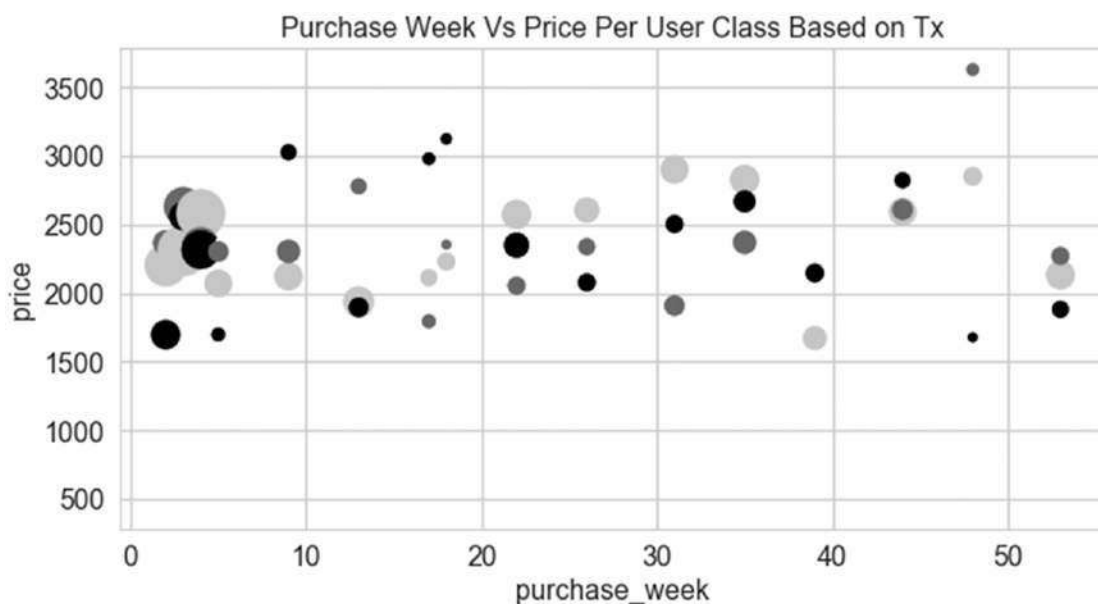

**Figure 3-30.** Scatter plot showing spread of data across `purchase_week` and `price`

Scatter plot also provides us the capability to visualize more than the basic dimensions. We can plot third and fourth dimensions using color and size. The following snippet helps us understand the spread with color denoting the `user_class` while size of the bubble indicates number of transaction.

```
bubble_df.plot.scatter(x='purchase_week',
                      y='price',
                      c=bubble_df['enc_uclass'],
                      s=bubble_df['total_transactions']*10)
plt.title('Purchase Week Vs Price Per User Class Based on Tx')
```

The parameters are self-explanatory—*c* represents color while *s* stands for size of the bubble. Such plots are also called *bubble charts*. The output generated is shown in Figure 3-31.



**Figure 3-31.** Scatter plot visualizing multi dimensional data

In this section, we utilized pandas to plot all sorts of visualizations. These were some of the most widely used visualizations and pandas provides a lot of flexibility to do more with these. Also, there is an extended list of plots that can be visualized using pandas. The complete information is available on the pandas documentation.

## Visualizing with Matplotlib

`matplotlib` is a popular plotting library. It provides interfaces and utilities to generate publication quality visualizations. Since its first version in 2003 until today, `matplotlib` is being continuously improved by its active developer community. It also forms the base and inspiration of many other plotting libraries. As discussed in the previous section, pandas along with SciPy (another popular Python library for scientific computing) provide wrappers over `matplotlib` implementations for ease of visualizing data.

`matplotlib` provides two primary modules to work with, `pylab` and `pyplot`. In this section, we will concentrate only on `pyplot` module (the use of `pylab` is not much encouraged). The `pyplot` interface is an object oriented interface that favors explicit instantiations as opposed to `pylab`'s implicit ones.

In the previous section, we briefly introduced different visualizations and saw a few ways of tweaking them as well. Since pandas visualizations are derived from `matplotlib` itself, we will cover additional concepts and capabilities of `matplotlib`. This will enable you to not only use `matplotlib` with ease but also provide with tricks to improve visualizations generated using pandas.

## Figures and Subplots

First things first. The base of any matplotlib style visualization begins with figure and subplot objects. The figure module helps matplotlib generate the plotting window object and its associated elements. In short, it is the top-level container for all visualization components. In matplotlib syntax, a figure is the top-most container and, within one figure, we have the flexibility to visualize multiple plots. Thus, subplots are the plots within the high-level figure container.

Let's get started with a simple example and the required imports. We will then build on the example to better understand the concept of figure and subplots. The following snippet imports the pyplot module of matplotlib and plots a simple sine curve using numpy to generate  $x$  and  $y$  values.

```
import numpy as np
import matplotlib.pyplot as plt

# sample plot
x = np.linspace(-10, 10, 50)
y=np.sin(x)

plt.plot(x,y)
plt.title('Sine Curve using matplotlib')
plt.xlabel('x-axis')
plt.ylabel('y-axis')
```

The pyplot module exposes methods such as `plot()` to generate visualizations. In the example, with `plt.plot(x, y)`, matplotlib is working behind the scenes to generate the figure and axes objects to output the plot in Figure 3-32. For completeness' sake, the statements `plt.title()`, `plt.xlabel()`, and so on provide ways to set the figure title and axis labels, respectively.

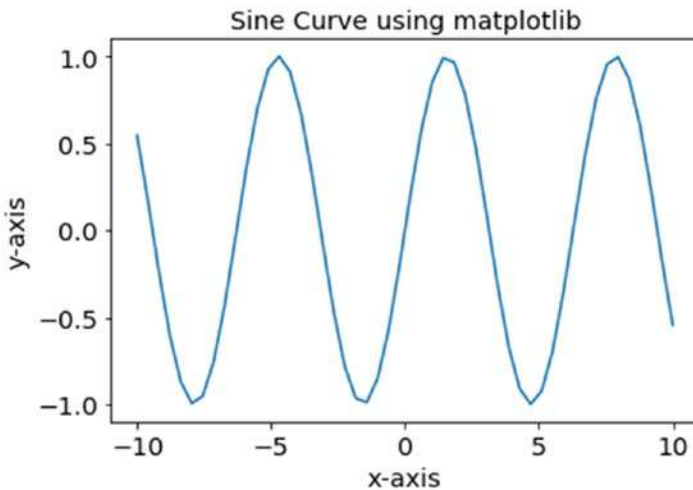

**Figure 3-32.** Sample plot

Now that we have a sample plot done, let's look at how different objects interact in the `matplotlib` universe. As mentioned, the `Figure` object is the top-most container of all elements. Before complicating things, we begin by first plotting different figures, i.e., each figure containing only a single plot. The following snippet plots a sine and a cosine wave in two different figures using `numpy` and `matplotlib`.

```
# first figure
plt.figure(1)
plt.plot(x,y)
plt.title('Fig1: Sine Curve')
plt.xlabel('x-axis')
plt.ylabel('y-axis')

# second figure
plt.figure(2)
y=np.cos(x)
plt.plot(x,y)
plt.title('Fig2: Cosine Curve')
plt.xlabel('x-axis')
plt.ylabel('y-axis')
```

The statement `plt.figure()` creates an instance of type `Figure`. The number passed in as a parameter is the figure identifier, which is helpful while referring to the same figure in case multiple exist. The rest of the statements are similar to our sample plot with `pyplot` always referring to the current figure object to draw to. Note that the moment a new figure is instantiated, `pyplot` refers to the newly created objects unless specified otherwise. The output generated is shown in Figure 3-33.

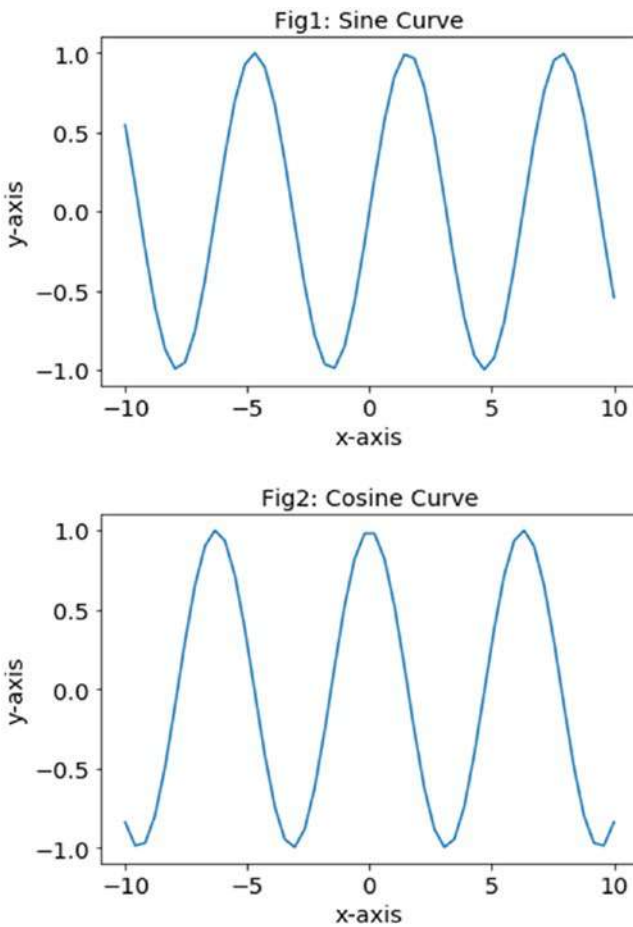

**Figure 3-33.** Multiple figures using matplotlib

We plot multiple figures while telling the data story for a use case. Yet, there are cases where we need multiple plots in the same figure. This is where the concept of subplots comes into the picture. A subplot divides a figure into a grid of specified rows and columns and also provides interfaces to interact with plotting elements. Subplots can be generated using a few different ways and their use depends on personal preferences and use case demands. We begin with the most intuitive one, the `add_subplot()` method. This method is exposed through the figure object itself. Its parameters help define the grid layout and other properties. The following snippet generates four subplots in a figure.

```
y = np.sin(x)
figure_obj = plt.figure(figsize=(8, 6))
ax1 = figure_obj.add_subplot(2,2,1)
ax1.plot(x,y)

ax2 = figure_obj.add_subplot(2,2,2)
ax3 = figure_obj.add_subplot(2,2,3)
```

```
ax4 = figure_obj.add_subplot(2,2,4)
ax4.plot(x+10,y)
```

This snippet first defines a figure object using `plt.figure()`. We then get an axes object pointing to the first subplot generated using the statement `figure_obj.add_subplot(2,2,1)`. This statement is actually dividing the figure into two rows and two columns. The last parameter (value 1) is pointing to the first subplot in this grid. The snippet is simply plotting the sine curve in the top-left subplot (identified as 2,2,1) and another sine curve shifted by 10 units on the x-axis in the fourth subplot (identified as 2,2,4). The output generated is shown in Figure 3-34.

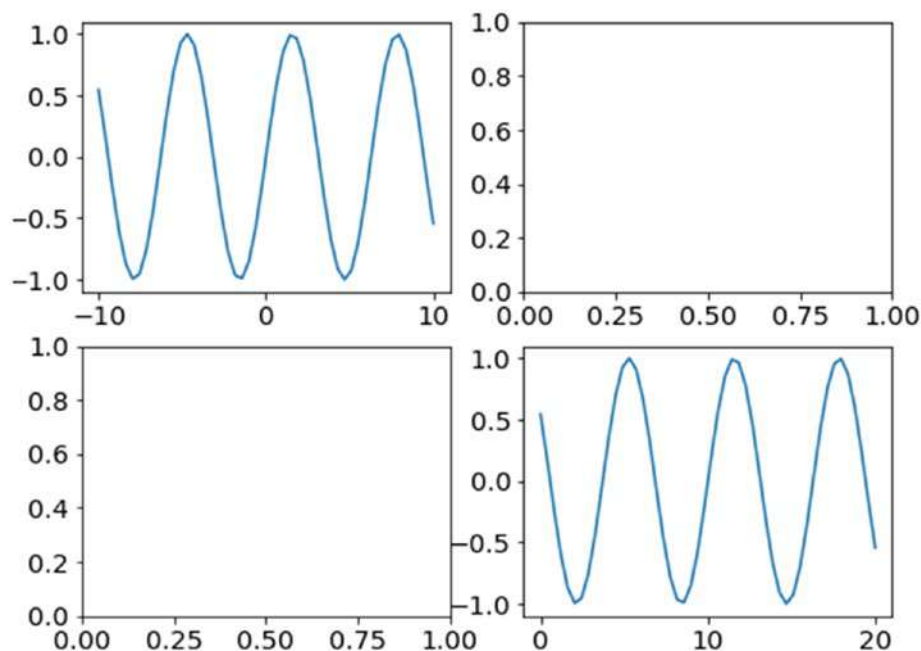

**Figure 3-34.** Subplots using `add_subplot` method

The second method for generating subplots is through the `pyplot` module directly. The `pyplot` module exposes a method `subplots()`, which returns figure object and a list of axes object, each of which is pointing to a subplot in the layout mentioned in the `subplots()` parameters. This method is useful when we have an idea about how many subplots will be required. The following snippet showcases the same.

```
fig, ax_list = plt.subplots(2,1,sharex=True, figsize=(8, 6))
y = np.sin(x)
ax_list[0].plot(x,y)

y = np.cos(x)
ax_list[1].plot(x,y)
```

The statement `plt.subplots(2,1,sharex=True)` does three things in one go. It first of all generates a figure object which is then divided into 2 rows and 1 column each (i.e., two subplots in total). The two subplots are returned in the form of a list of axes objects. The final and the third thing is the sharing of x-axis, which we achieve using the parameter `sharex`. This sharing of x-axis allows all subplots in this figure



to have the same x-axis. This allows us to view data on the same scale along with aesthetic improvements. The output is depicted in Figure 3-35 showcasing sine and cosine curves on the same x-axis.

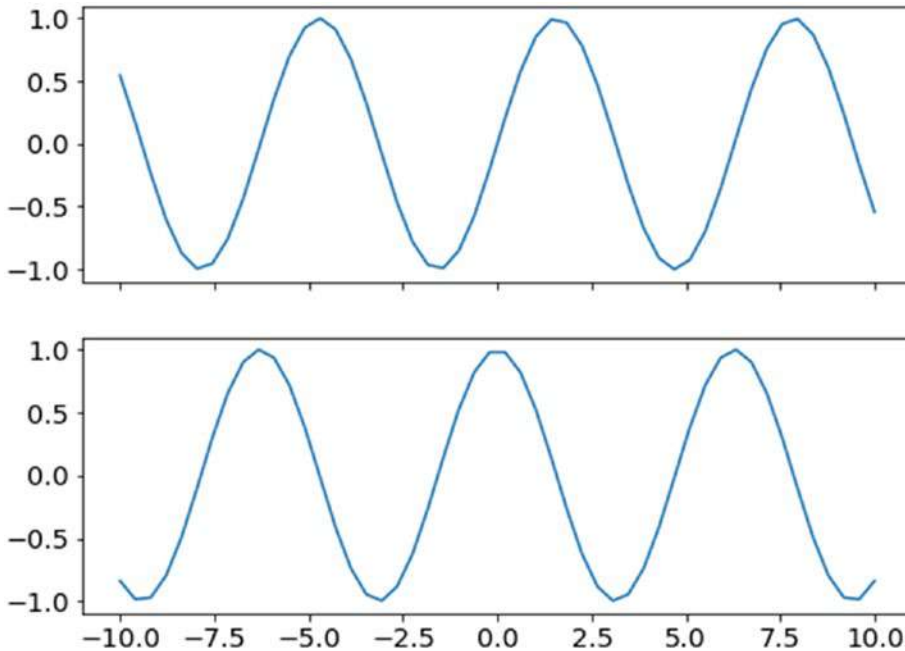

**Figure 3-35.** Subplots using `subplots()` method

Another variant is the `subplot()` function, which is also exposed through the `pyplot` module directly. This closely emulates the `add_subplot()` method of the figure object. You can find examples listed in the code for this chapter. Before moving onto other concepts, we quickly touch on the `subplot2grid()` function, also exposed through the `pyplot` module. This function provides capabilities similar to the ones already discussed along with finer control to define grid layout where subplots can span an arbitrary number of columns and rows. The following snippet showcases a grid with subplots of different sizes.

```
y = np.abs(x)
z = x**2

plt.subplot2grid((4,3), (0, 0), rowspan=4, colspan=2)
plt.plot(x, y, 'b', x, z, 'r')

ax2 = plt.subplot2grid((4,3), (0, 2), rowspan=2)
plt.plot(x, y, 'b')
plt.setp(ax2.get_xticklabels(), visible=False)

plt.subplot2grid((4,3), (2, 2), rowspan=2)
plt.plot(x, z, 'r')
```

The `subplot2grid()` function takes a number of parameters, explained as follows:

- `shape`: A tuple representing rows and columns in the grid as (rows, columns).
- `loc`: A tuple representing the location of a subplot. This parameter is 0 indexed.
- `rowspan`: This parameter represents the number of rows the subplot covers.
- `colspan`: This parameter represents the number of columns the subplot extends to.

The output generated in Figure 3-36 by the snippet has one subplot covering four rows and two columns containing two functions. The other two subplots cover two rows and one column each.

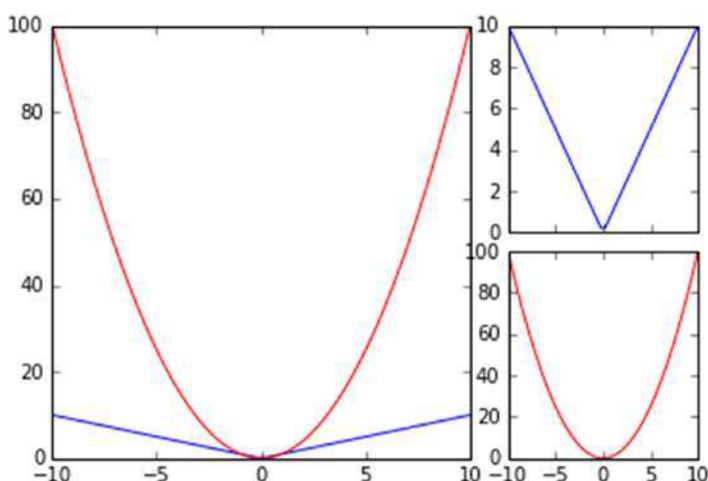

**Figure 3-36.** Subplots using `subplot2grid()`

## Plot Formatting

Formatting a plot is another important aspect of storytelling and `matplotlib` provides us plenty of features here. From changing colors to markers and so on, `matplotlib` provides easy-to-use intuitive interfaces.

We begin with the color attribute, which is available as part of the `plot()` interface. The color attribute works on the RGBA specifications, allowing us to provide alpha and color values as strings (red, green, and so on), as single letters (r, g, and so on) and even as hex values. More details are available on the `matplotlib` documentation at [https://matplotlib.org/api/colors\\_api.html](https://matplotlib.org/api/colors_api.html).

The following example and output depicted in Figure 3-37 illustrates how easy it is to set color and alpha properties for plots.

```
y = x

# color
ax1 = plt.subplot(321)
plt.plot(x,y,color='green')
ax1.set_title('Line Color')

# alpha
ax2 = plt.subplot(322,sharex=ax1)
alpha = plt.plot(x,y)
```

```
alpha[0].set_alpha(0.3)
ax2.set_title('Line Alpha')
plt.setp(ax2.get_yticklabels(), visible=False)
```

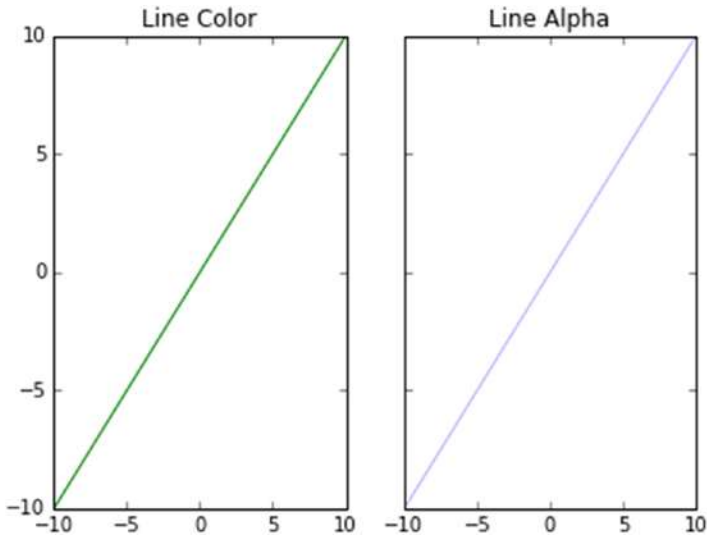
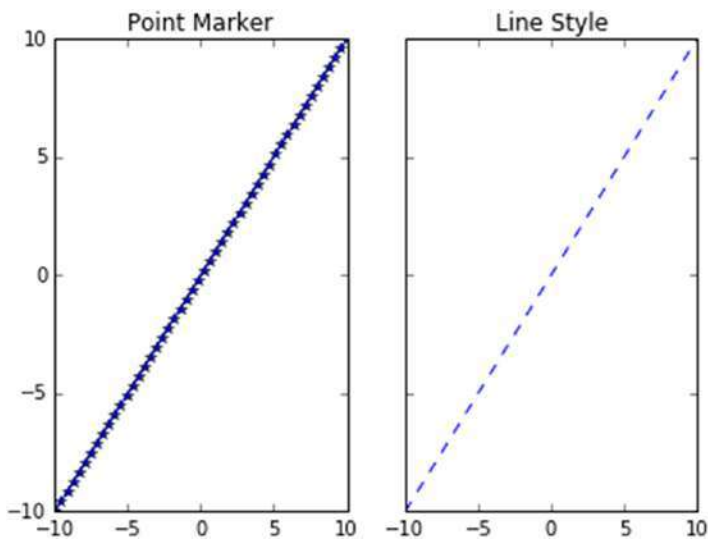

**Figure 3-37.** Setting color and alpha properties of a plot

Along the same lines, we also have options to use different shapes to mark data points as well as different styles to plot lines. These options come in handy while representing different attributes/classes onto the same plot. The following snippet and output depicted in Figure 3-38 showcase the same.

```
# marker
# markers -> '+', 'o', '*', 's', ',', '.', etc
ax3 = plt.subplot(323, sharex=ax1)
plt.plot(x,y,marker='*')
ax3.set_title('Point Marker')

# linestyle
# linestyles -> '-', '--', '-.', ':', 'steps'
ax4 = plt.subplot(324, sharex=ax1)
plt.plot(x,y,linestyle='--')
ax4.set_title('Line Style')
plt.setp(ax4.get_yticklabels(), visible=False)
```



**Figure 3-38.** Setting marker and line style properties of a plot

Though there are many more fine tuning options available, you are encouraged to go through the documentation for detailed information. We conclude the formatting section with final two tricks related to line width and a shorthand notation to do it all quickly, as shown in the following snippet.

```
# line width
ax5 = plt.subplot(325,sharex=ax1)
line = plt.plot(x,y)
line[0].set_linewidth(3.0)
ax5.set_title('Line Width')

# combine linestyle
ax6 = plt.subplot(326,sharex=ax1)
plt.plot(x,y,'b^')
ax6.set_title('Styling Shorthand')
plt.setp(ax6.get_yticklabels(), visible=False)
```

This snippet uses the line object returned by the `plot()` function to set the line width. The second part of the snippet showcases the shorthand notation to set the line color and data point marker in one go as, `b^`. The output shown in Figure 3-39 helps show this effect.

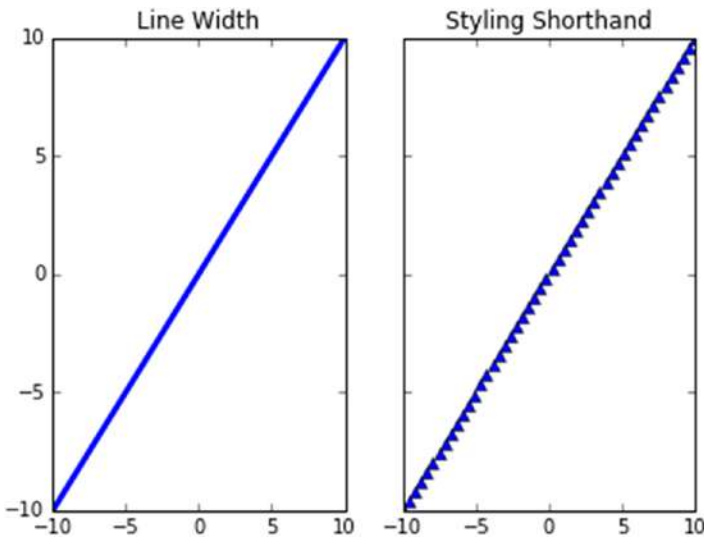

**Figure 3-39.** Example to show `line_width` and shorthand notation

## Legends

A graph legend is a key that helps us map color/shape or other attributes to different attributes being visualized by the plot. Though in most cases `matplotlib` does a wonderful job at preparing and showing the legends, there are times when we require a finer level of control.

The legend of a plot can be controlled using the `legend()` function, available through the `pyplot` module directly. We can set the location, size, and other formatting attributes through this function. The following example shows the legend being placed in the best possible location.

```
plt.plot(x,y,'g',label='y=x^2')
plt.plot(x,z,'b:',label='y=x')
plt.legend(loc="best")
plt.title('Legend Sample')
```

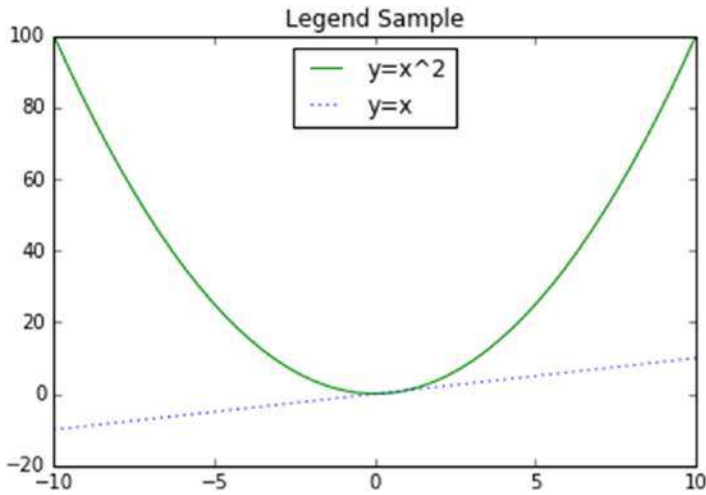

**Figure 3-40.** Sample plot with legend

One of the primary goals of `matplotlib` is to provide publication quality visualizations. `matplotlib` supports LaTeX style formatting of the legends to cleanly visualize mathematical symbols and equations. The `$` symbol is used to mark the start and end of LaTeX style formatting. The same is shown in the following snippet and output plot (see Figure 3-41).

```
# legend with latex formatting
plt.plot(x,y,'g',label='$y = x^2$')
plt.plot(x,z,'b:',linewidth=3,label='$y = x^2$')
plt.legend(loc="best",fontsize='x-large')
plt.title('Legend with $LaTeX$ formatting')
```

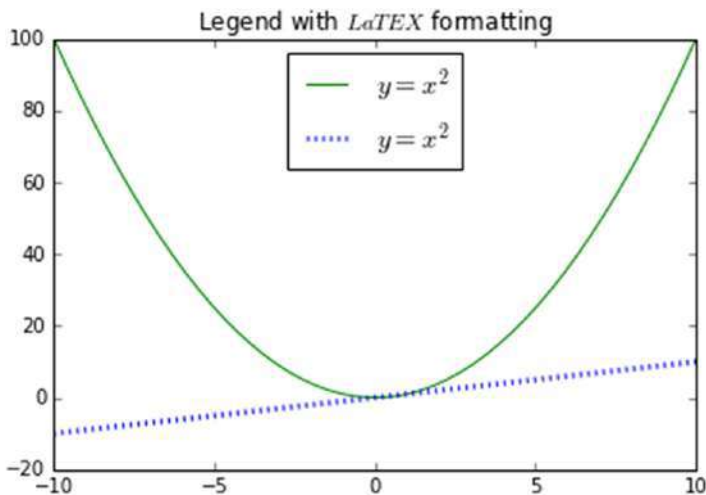

**Figure 3-41.** Sample plot with LaTeX formatted legend

## Axis Controls

The next feature from `matplotlib` is the ability to control the x- and y-axes of a plot. Apart from basic features like setting the axis labels and colors using the methods `set_xlabel()` and `set_ylabel()`, there are finer controls available as well. Let's first see how to add a secondary y-axis. There are many scenarios when we plot data related to different features (having values at different scales) on the same plot. To get a proper understanding, it usually helps to have both features on different y-axis (each scaled to respective range). To get additional y-axis, we use the function `twinx()` exposed through the axes object. The following snippet outlines the scenario.

```
## axis controls
# secondary y-axis
fig, ax1 = plt.subplots()
ax1.plot(x,y,'g')
ax1.set_ylabel(r"primary y-axis", color="green")

ax2 = ax1.twinx()

ax2.plot(x,z,'b:',linewidth=3)
ax2.set_ylabel(r"secondary y-axis", color="blue")

plt.title('Secondary Y Axis')
```

At first it may sound odd to have a function named `twinx()` to generate secondary y-axis. Smartly, `matplotlib` has such a function to point out the fact that the additional y-axis would share the same x-axis and hence the name `twinx()`. On the same lines, additional x-axis is obtained using the function `twiny()`. The output plot is depicted in Figure 3-42.

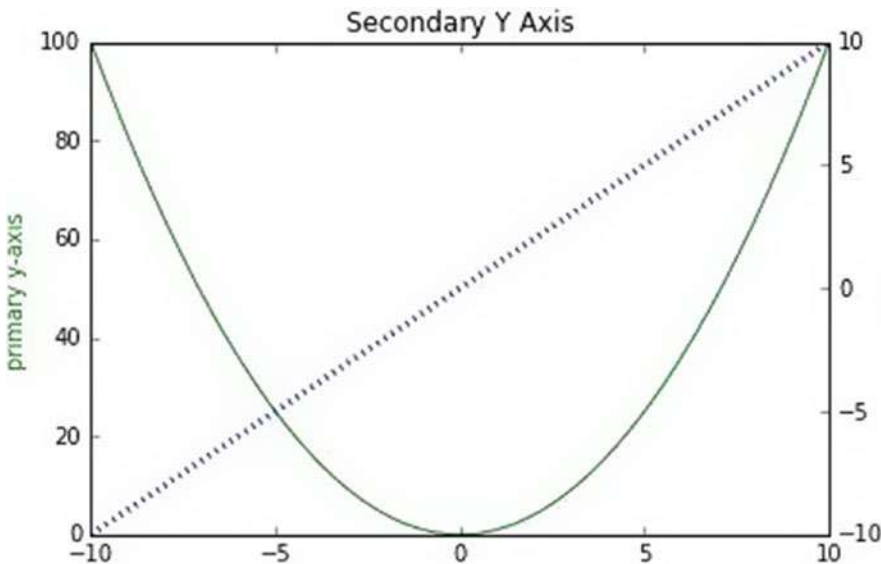

**Figure 3-42.** Sample plot with secondary y-axis

By default, `matplotlib` identifies the range of values being plotted and adjusts the ticks and the range of both x- and y-axes. It also provides capability to manually set these through the `axis()` function. Through this function, we can set the axis range using predefined keywords like `tight`, `scaled`, and `equal`, along with passing a list such that it marks the values as `[xmin, xmax, ymin, ymax]`. The following snippet shows how to adjust axis range manually.

```
# manual
y = np.log(x)
z = np.log2(x)
w = np.log10(x)

plt.plot(x,y,'r',x,z,'g',x,w,'b')
plt.axis([0,2,-1,2])
plt.title('Manual Axis Range')
```

The output in Figure 3-43 showcases the plot generated without any axis adjustments on the left, while the right one shows the axis adjustment as done in the previous snippet.

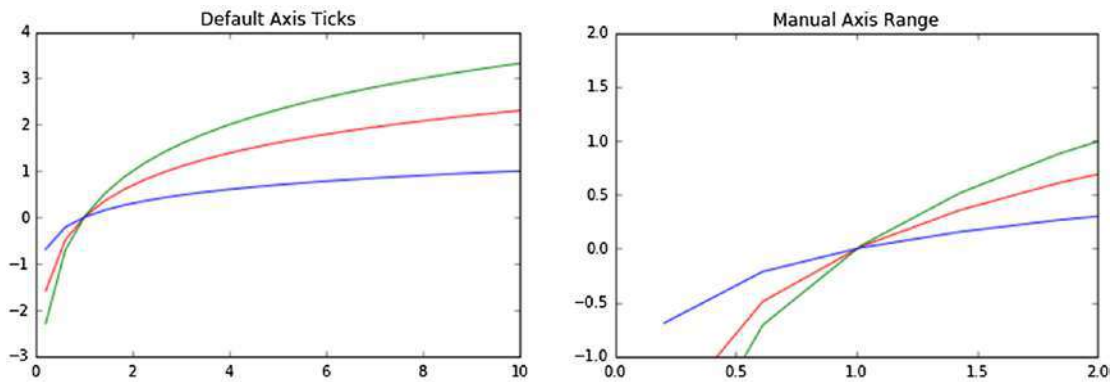

**Figure 3-43.** Plots showcasing default axis and manually adjusted axis

Now that we have seen how to set the axis range, we will quickly touch on setting the ticks or axis markers manually as well. For axis ticks, we have two separate functions available, one for setting the range of ticks while the second sets the tick labels. The functions are intuitively named as `set_ticks()` and `set_ticklabels()`, respectively. In the following example, we set the ticks to be marked for the x-axis while for y-axis we set both the tick range and the labels using the appropriate functions.

```
# Manual ticks
plt.plot(x, y)
ax = plt.gca()

ax.xaxis.set_ticks(np.arange(-2, 2, 1))

ax.yaxis.set_ticks(np.arange(0, 5))
ax.yaxis.set_ticklabels(["min", 2, 4, "max"])

plt.grid(True)
plt.title("Manual ticks on the x-axis")
```



The output is a plot with x-axis having labels marked only between -2 and 1, while y-axis has a range of 0 to 5 with labels changed manually. The output plot is shown in Figure 3-44.

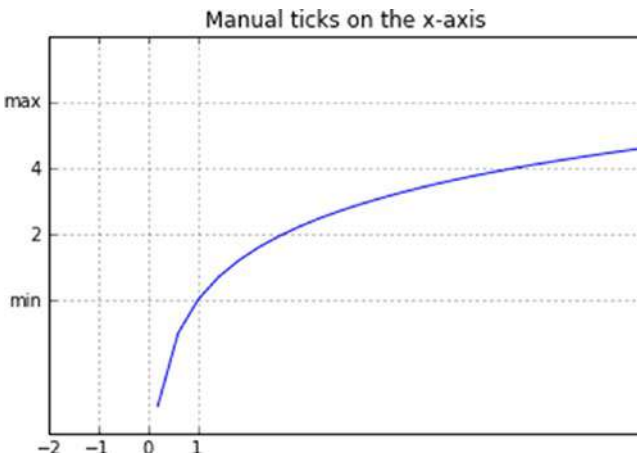

**Figure 3-44.** Plot showcasing axes with manual ticks

Before we move on to next set of features/capabilities, it is worth noting that with `matplotlib`, we also get the capability of scaling the axis based on the data range in a standard manner apart from manually setting it (as seen previously). The following is a quick snippet scaling the y-axis on a log scale. The output is shown in Figure 3-45.

```
# scaling
plt.plot(x, y)
ax = plt.gca()
# values: log, logit, symlog
ax.set_yscale("log")
plt.grid(True)
plt.title("Log Scaled Axis")
```

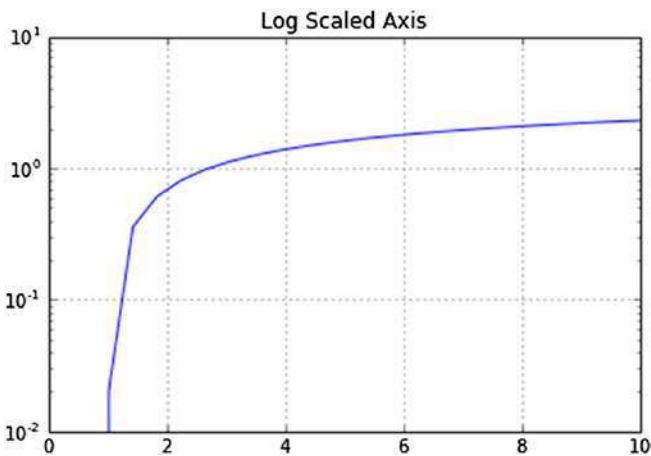

**Figure 3-45.** Plot showcasing log scaled y-axis

## Annotations

The `text()` interface from the `pyplot` module exposes the annotation capabilities of `matplotlib`. We can annotate any part of the figure/plot/subplot using this interface. It takes the `x` and `y` coordinates, the text to be displayed, alignment, and `fontsize` parameters as inputs to place the annotations at the desired place on the plot. The following snippet annotates the minima of a parabolic plot.

```
# annotations
y = x**2
min_x = 0
min_y = min_x**2

plt.plot(x, y, "b-", min_x, min_y, "ro")
plt.axis([-10,10,-25,100])

plt.text(0, 60, "Parabola\n$y = x^2$", fontsize=15, ha="center")
plt.text(min_x, min_y+2, "Minima", ha="center")
plt.text(min_x, min_y-6, "(%0.1f, %0.1f)"%(min_x, min_y), ha='center',color='gray')
plt.title("Annotated Plot")
```

The `text()` interface provides many more capabilities and formatting features. You are encouraged to go through the official documentation and examples for details on this. The output plot showcasing the annotated parabola is shown in Figure 3-46.

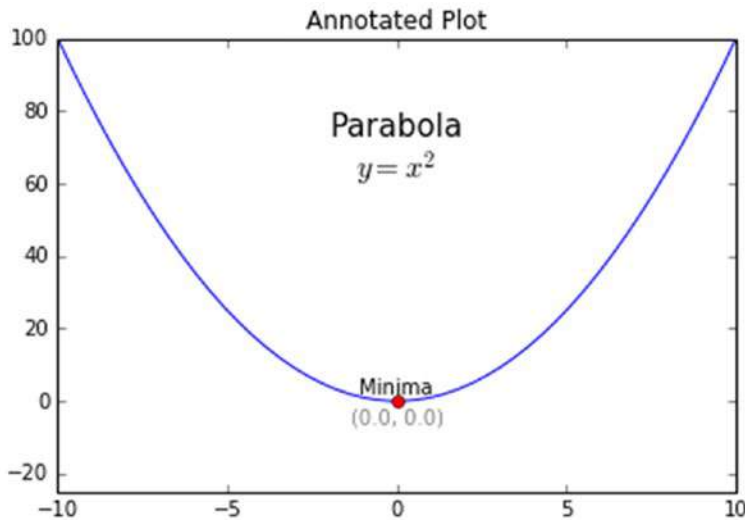

**Figure 3-46.** Plot showcasing annotations

## Global Parameters

To maintain consistency, we usually try to keep the plot sizes, fonts, and colors the same across the visual story. Setting each of these attributes creates complexity and difficulties in maintaining the code base. To overcome these issues, we can set formatting settings globally, as shown in the following snippet.

```
# global formatting params
params = {'legend.fontsize': 'large',
         'figure.figsize': (10, 10),
         'axes.labelsize': 'large',
         'axes.titlesize': 'large',
         'xtick.labelsize': 'large',
         'ytick.labelsize': 'large'}

plt.rcParams.update(params)
```

Once set using `rcParams.update()`, the attributes provided in the `params` dictionary are applied to every plot generated. You are encouraged to apply these setting and generate the plots discussed in this section again to understand the difference.

## Python Visualization Ecosystem

The `matplotlib` library is a very powerful and popular visualization/plotting library without any doubts. It provides most of the tools and tricks required to plot any type of data with capability to control even the finest elements.

Yet `matplotlib` leaves a lot more to be desired by even pro-users. Being a low-level API, it requires a lot of boilerplate code, interactivity is limited, and styling and other formatting defaults seem dated.

To address these issues and provide high-level interfaces and ability to work with current Python ecosystem, the Python universe has quite a few visualization libraries to choose from. Some of the most popular and powerful ones are `bokeh`, `seaborn`, `ggplot`, and `plotly`. Each of these libraries builds on the understanding and feature set of `matplotlib`, while providing their own set of features and easy-to-use wrappers to plug the gaps.

You are encouraged to explore these libraries and understand the differences. We will introduce some of these in the coming chapters as and when required. Though different, most libraries work on concepts similar to `matplotlib` and hence the learning curve is shorter if you're well versed in `matplotlib`.

## Summary

This chapter covered quite a lot of ground in terms of understanding, processing, and wrangling data. We covered major data formats like flat files (CSV, JSON, XML, HTML, etc.), and used standard libraries to extract/collect data. We touched on standard data types and their importance in the overall process of data science. Major part of this chapter covered data wrangling tasks to transform, clean, and process data so as to bring it into usable form. Though the techniques were explained using the `pandas` library, the concepts are universal and applied in most Data Science related use cases. You may use these techniques as pointers that can be easily applied using different libraries and programming/scripting languages. We covered major plots using sample datasets describing their usage. We also touched on the basics and the powerful tricks of `matplotlib`. We strongly encourage you to read the referred links for in-depth understanding. This chapter covers the initial steps in the *CRISP DM* model of data collection, processing, and visualization. In the coming chapters, we build on these concepts and apply them for solving specific real-world problems. Stay tuned!

## CHAPTER 4



# Feature Engineering and Selection

Building Machine Learning systems and pipelines take significant effort, which is evident from the knowledge you gained in the previous chapters. In the first chapter, we presented some high-level architecture for building Machine Learning pipelines. The path from data to insights and information is not an easy and direct one. It is tough and also iterative in nature involving data scientists and analysts to reiterate through several steps multiple times to get to the perfect model and derive correct insights. The limitation of Machine Learning algorithms is the fact that they can only understand numerical values as inputs. This is because, at the heart of any algorithm, we usually have multiple mathematical equations, constraints, optimizations and computations. Hence it is almost impossible for us to feed raw data into any algorithm and expect results. This is where features and attributes are extremely helpful in building models on top of our data.

Building machine intelligence is a multi-layered process having multiple facets. In this book, so far, we have already explored how you can retrieve, process, wrangle, and visualize data. Exploratory data analysis and visualizations are the first step toward understanding your data better. Understanding your data involves understanding the complete scope encompassing your data including the domain, constraints, caveats, quality and available attributes. From Chapter 3, you might remember that data is comprised of multiple fields, attributes, or variables. Each attribute by itself is an inherent feature of the data. You can then derive further features from these inherent features and this itself forms a major part of feature engineering. Feature selection is another important task that comes hand in hand with feature engineering, where the data scientist is tasked with selecting the best possible subset of features and attributes that would help in building the right model.

An important point to remember here is that feature engineering and selection is not a one-time process which should be carried out in an ad hoc manner. The nature of building Machine Learning systems is iterative (following the *CRISP-DM* principle) and hence extracting and engineering features from the dataset is not a one-time task. You may need to extract new features and try out multiple selections each time you build a model to get the best and optimal model for your problem. Data processing and feature engineering is often described to be the toughest task or step in building any Machine Learning system by data scientists. With the need of both domain knowledge as well as mathematical transformations, feature engineering is often said to be both an art as well as a science. The obvious complexities involve dealing with diverse types of data and variables. Besides this, each Machine Learning problem or task needs specific features and there is no one solution fits all in the case of feature engineering. This makes feature engineering all the more difficult and complex.

Hence we follow a proper structured approach in this chapter covering the following three major areas in the feature engineering workflow. They are mentioned as follows.

- Feature extraction and engineering
- Feature scaling
- Feature selection

This chapter covers essential concepts for all the three major areas mentioned above. Techniques for feature engineering will be covered in detail for diverse data types including numeric, categorical, temporal, text and image data. We would like to thank our good friend and fellow data scientist, Gabriel Moreira for helping us with some excellent compilations of feature engineering techniques over these diverse data types. We also cover different feature scaling methods typically used as a part of the feature engineering process to normalize values preventing higher valued features from taking unnecessary prominence. Several feature selection techniques like filter, wrapper, and embedded methods will also be covered. Techniques and concepts will be supplemented with sufficient hands-on examples and code snippets. Remember to check out the relevant code under Chapter 4 in the GitHub repository at <https://github.com/dipanjanS/practical-machine-learning-with-python> which contains necessary code, notebooks, and data. This will make things easier to understand, help you gain enough knowledge to know which technique should be used in which scenario and thus help you get started on your own journey toward feature engineering for building Machine Learning models!

## Features: Understand Your Data Better

The essence of any Machine Learning model is comprised of two components namely, data and algorithms. You might remember the same from the Machine Learning paradigm which we introduced in Chapter 1. Any Machine Learning algorithm is at essence a combination of mathematical functions, equations and optimizations which are often augmented with business logic as needed. These algorithms are not intelligent enough to usually process raw data and discover latent patterns from the same which would be used to train the system. Hence we need better data representations for building Machine Learning models, which are also known as data features or attributes. Let's look at some important concepts associated with data and features in this section.

### Data and Datasets

Data is essential for analytics and Machine Learning. Without data we are literally powerless to implement any intelligent system. The formal definition of data would be a collection or set of qualitative and/or quantitative variables containing values based on observations. Typically data is usually measured and collected from various observations. This is then stored in its raw form which can then be processed further and analyzed as required. Typically in any analytics or Machine Learning system, you might need multiple sources of data and processed data from one component can be fed as raw data to another component for further processing. Data can be structured having definite rows and columns indicating observations and attributes or unstructured like free textual data.

A dataset can be defined as a collection of data. Typically this indicates data present in the form of flat files like CSV files or MS Excel files, relational database tables or views, or even raw data two-dimensional matrices. Sample datasets which are quite popular in Machine Learning are available in the scikit-learn package to quickly get started. The `sklearn.datasets` module has these sample datasets readily available and other utilities pertaining to loading and handling datasets. You can find more details in this link <http://scikit-learn.org/stable/datasets/index.html#datasets> to learn more about the toy datasets and best practices for handling and loading data. Another popular resource for Machine Learning based datasets is the UC Irvine Machine Learning repository which can be found here <http://archive.ics.uci.edu/ml/index.php> and this contains a wide variety of datasets from real-world problems, scenarios and devices. In fact the popular Machine Learning and predictive analytics competitive platform Kaggle also features some datasets from UCI and other datasets pertaining to various competitions. Feel free to check out these resources and we will in fact be using some datasets from these resources in this chapter as well as in subsequent chapters.

## Features

Raw data is hardly used to build any Machine Learning model, mostly because algorithms can't work with data which is not properly processed and wrangled in a desired format. Features are attributes or properties obtained from raw data. Each feature is a specific representation on top of the raw data. Typically, each feature is an individual measurable attribute which usually is depicted by a column in a two dimensional dataset. Each observation is depicted by a row and each feature will have a specific value for an observation. Thus each row typically indicates a feature vector and the entire set of features across all the observations forms a two-dimensional feature matrix also known as a feature set. Features are extremely important toward building Machine Learning models and each feature represents a specific chunk of representation and information from the data which is used by the model. Both quality as well as quantity of features influences the performance of the model.

Features can be of two major types based on the dataset. Inherent raw features are obtained directly from the dataset with no extra data manipulation or engineering. Derived features are usually what we obtain from feature engineering where we extract features from existing data attributes. A simple example would be creating a new feature *Age* from an employee dataset containing *Birthdate* by just subtracting their birth date from the current date. The next major section covers more details on how to handle, extract, and engineer features based on diverse data types.

## Models

Features are better representations of underlying raw data which act as inputs to any Machine Learning model. Typically a model is comprised of data features, optional class labels or numeric responses for supervised learning and a Machine Learning algorithm. The algorithm is chosen based on the type of problem we want to solve after converting it into a specific Machine Learning task. Models are built after training the system on data features iteratively till we get the desired performance. Thus, a model is basically used to represent relationships among the various features of our data.

Typically the process of modeling involves multiple major steps. Model building focuses on training the model on data features. Model tuning and optimization involves tuning specific model parameters, known as hyperparameters and optimizing the model to get the best model. Model evaluation involves using standard performance evaluation metrics like accuracy to evaluate model performance. Model deployment is usually the final step where, once we have selected the most suitable model, we deploy it live in production which usually involves building an entire system around this model based on the CRISP-DM methodology. Chapter 5 will focus on these aspects in further detail.

## Revisiting the Machine Learning Pipeline

We covered the standard Machine Learning pipeline in detail in Chapter 1, which was based on the CRISP-DM standard. Let's refresh our memory by looking at Figure 4-1, which depicts our standard generic Machine Learning pipeline with the major components identified with the various building blocks.

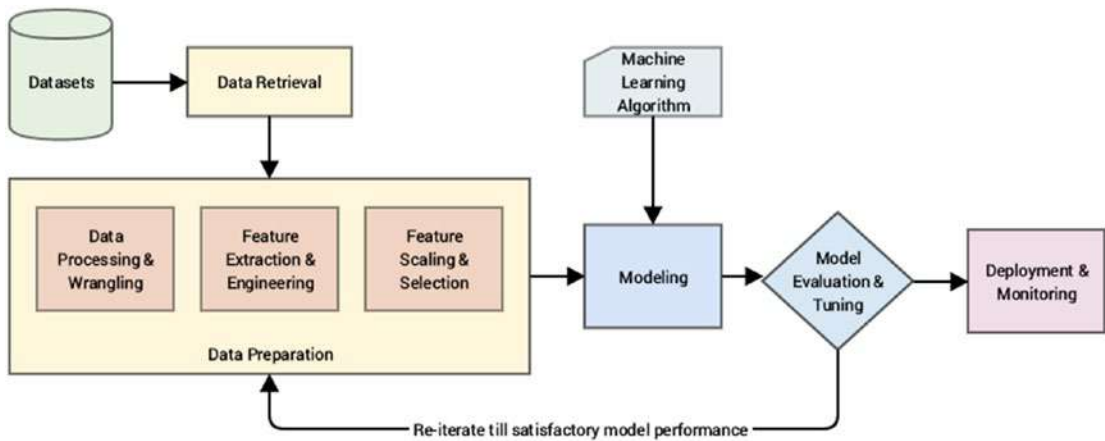

**Figure 4-1.** Revisiting our standard Machine Learning pipeline

The figure clearly depicts the main components in the pipeline, which you should already be well-versed on by now. These components are mentioned once more for ease of understanding.

- Data retrieval
- **Data preparation**
- Modeling
- Model evaluation and tuning
- Model deployment and monitoring

Our area of focus in this chapter falls under the blocks under “Data Preparation”. We already covered processing and wrangling data in Chapter 3 in detail. Here, we will be focusing on the three major steps essential toward handling data features. These are mentioned as follows.

1. Feature extraction and engineering
2. Feature scaling
3. Feature selection

These blocks are highlighted in Figure 4-1 and are essential toward the process of transforming processed data into features. By processed, we mean the raw data, after going through necessary pre-processing and wrangling operations. The sequence of steps that are usually followed in the pipeline for transforming processed data into features is depicted in a more detailed view in Figure 4-2.

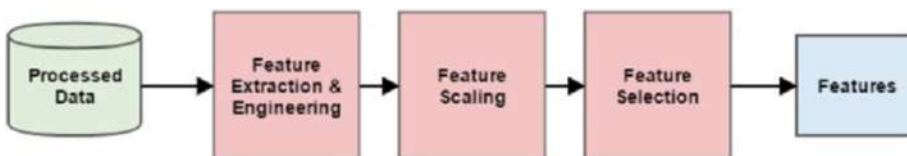

**Figure 4-2.** A standard pipeline for feature engineering, scaling, and selection

It is quite evident that based on the sequence of steps depicted in the figure, features are first crafted and engineering, necessary normalization and scaling is performed and finally the most relevant features are selected to give us the final set of features. We will cover these three components in detail in subsequent sections following the same sequence as depicted in the figure.

## Feature Extraction and Engineering

The process of feature extraction and engineering is perhaps the most important one in the entire Machine Learning pipeline. Good features depicting the most suitable representations of the data help in building effective Machine Learning models. In fact, more than often it's not the algorithms but the features that determine the effectiveness of the model. In simple words, good features give good models. A data scientist approximately spends around 70% to 80% of his time in data processing, wrangling, and feature engineering for building any Machine Learning model. Hence it's of paramount importance to understand all aspects pertaining to feature engineering if you want to be proficient in Machine Learning.

Typically feature extraction and feature engineering are synonyms that indicate the process of using a combination of domain knowledge, hand-crafted techniques and mathematical transformations to convert data into features. Henceforth we will be using the term *feature engineering* to refer to all aspects concerning the task of extracting or creating new features from data. While the choice of Machine Learning algorithm is very important when building a model, more than often, the choice and number of features tend to have more impact toward the model performance. In this section, we will be looking to answer some questions such as the why, what, and how of feature engineering to get a more in-depth understanding toward feature engineering.

### What Is Feature Engineering?

We already informally explained the core concept behind feature engineering, where we use specific components from domain knowledge and specific techniques to transform data into features. Data in this case is raw data after necessary pre-processing and wrangling, which we have mentioned earlier. This includes dealing with bad data, imputing missing values, transforming specific values, and so on. Features are the final end result from the process of feature engineering, which depicts various representations of the underlying data.

Let's now look at a couple of definitions and quotes relevant to feature engineering from several renowned people in the world of data science! Renowned computer and data scientist Andrew Ng talks about Machine Learning and feature engineering.

*“Coming up with features is difficult, time-consuming, requires expert knowledge. ‘Applied Machine Learning’ is basically feature engineering.”*

—Prof. Andrew Ng

This basically reinforces what we mentioned earlier about data scientists spending close to 80% of their time in engineering features which is a difficult and time-consuming process, requiring both domain knowledge and mathematical computations. Besides this, practical or applied Machine Learning is mostly feature engineering because the time taken in building and evaluating models is considerably less than the total time spent toward feature engineering. However, this doesn't mean that modeling and evaluation are any less important than feature engineering.



We will now look at a definition of feature engineering by Dr. Jason Brownlee, data scientist and ML practitioner who provides a lot of excellent resources over at <http://machinelearningmastery.com> with regard to Machine Learning and data science. Dr. Brownlee defines feature engineering as follows.

*“Feature engineering is the process of transforming **raw data** into **features** that better represent **the underlying problem** to **the predictive models**, resulting in improved **model accuracy** on **unseen data**.”*

—Dr. Jason Brownlee

Let’s spend some more time on this definition of feature engineering. It tells us that the process of feature engineering involves transforming data into features taking into account several aspects pertaining to the problem, model, performance, and data. These aspects are highlighted in this definition and are explained in further detail as follows.

- **Raw data:** This is data in its native form after data retrieval from source. Typically some amount of data processing and wrangling is done before the actual process of feature engineering.
- **Features:** These are specific representations obtained from the raw data after the process of feature engineering.
- **The underlying problem:** This refers to the specific business problem or use-case we want to solve with the help of Machine Learning. The business problem is typically converted into a Machine Learning task.
- **The predictive models:** Typically feature engineering is used for extracting features to build Machine Learning models that learn about the data and the problem to be solved from these features. Supervised predictive models are widely used for solving diverse problems.
- **Model accuracy:** This refers to model performance metrics that are used to evaluate the model.
- **Unseen data:** This is basically new data that was not used previously to build or train the model. The model is expected to learn and generalize well for unseen data based on good quality features.

Thus feature engineering is the process of transforming data into features to act as inputs for Machine Learning models such that good quality features help in improving the overall model performance. Features are also very much dependent on the underlying problem. Thus, even though the Machine Learning task might be same in different scenarios, like classification of e-mails into spam and non-spam or classifying handwritten digits, the features extracted in each scenario will be very different from the other.

By now you must be getting a good grasp on the idea and significance of feature engineering. Always remember that for solving any Machine Learning problem, feature engineering is the key! This in fact is reinforced by Prof. Pedro Domingos from the University of Washington, in his paper titled, “A Few Useful Things to Know about Machine Learning” available at <http://homes.cs.washington.edu/~pedrod/papers/cacm12.pdf>, which tells us the following.

*“At the end of the day, some Machine Learning projects succeed and some fail. What makes the difference? Easily the most important factor is the features used.”*

—Prof. Pedro Domingos

Feature engineering is indeed both an art and a science to transform data into features for feeding into models. Sometimes you need a combination of domain knowledge, experience, intuition, and mathematical transformations to give you the features you need. By solving more problems over time, you will gain the experience you need to know what features might be best suited for a problem. Hence do not be overwhelmed, practice will make you master feature engineering with time. The following list depicts some examples of engineering features.

- Deriving a person's age from birth date and the current date
- Getting the average and median view count of specific songs and music videos
- Extracting word and phrase occurrence counts from text documents
- Extracting pixel information from raw images
- Tabulating occurrences of various grades obtained by students

The final quote to whet your appetite on feature engineering is from renowned Kagglers, Xavier Conort. Most of you already know that tough Machine Learning problems are often posted on Kaggle regularly which is usually open to everyone. Xavier's thoughts on feature engineering are mentioned as follows.

*"The algorithms we used are very standard for Kagglers. ...We spent most of our efforts in feature engineering. ...We were also very careful to discard features likely to expose us to the risk of over-fitting our model."*

—Xavier Conort

This should give you a good idea what is feature engineering, the various aspects surrounding it and a very basic introduction into why do we really need feature engineering. In the following section, we will expand more on why we need feature engineering, its benefits and advantages.

## Why Feature Engineering?

We have defined feature engineering in the previous section and also touched upon the basics pertaining to the importance of feature engineering. Let's now look at why we need feature engineering and how can it be an advantage for us when we are building Machine Learning models and working with data.

- **Better representation of data:** Features are basically various representations of the underlying raw data. These representations can be better understood by Machine Learning algorithms. Besides this, we can also often easily visualize these representations. A simple example would be to visualize the frequent word occurrences of a newspaper article as opposed to being totally perplexed as to what to do with the raw text!
- **Better performing models:** The right features tend to give models that outperform other models no matter how complex the algorithm is. In general if you have the right feature set, even a simple model will perform well and give desired results. In short, better features make better models.
- **Essential for model building and evaluation:** We have mentioned this numerous times by now, raw data cannot be used to build Machine Learning models. Get your data, extract features, and start building models! Also on evaluating model performance and tuning the models, you can reiterate over your feature set to choose the right set of features to get the best model.

- **More flexibility on data types:** While it is definitely easier to use numeric data types directly with Machine Learning algorithms with little or no data transformations, the real challenge is to build models on more complex data types like text, images, and even videos. Feature engineering helps us build models on diverse data types by applying necessary transformations and enables us to work even on complex unstructured data.
- **Emphasis on the business and domain:** Data scientists and analysts are usually busy in processing, cleaning data and building models as a part of their day to day tasks. This often creates a gap between the business stakeholders and the technical/ analytics team. Feature engineering involves and enables data scientists to take a step back and try to understand the domain and the business better, by taking valuable inputs from the business and subject matter experts. This is necessary to create and select features that might be useful for building the right model to solve the problem. Pure statistical and mathematical knowledge is rarely sufficient to solve a complex real-world problem. Hence feature engineering emphasizes to focus on the business and the domain of the problem when building features.

This list, though not an exhaustive one, gives us a pretty good insight into the importance of feature engineering and how it is an essential aspect of building Machine Learning models. The importance of the problem to be solved and the domain is also pretty important in feature engineering.

## How Do You Engineer Features?

There are no fixed rules for engineering features. It involves using a combination of domain knowledge, business constraints, hand-crafted transformations and mathematical transformations to transform the raw data into desired features. Different data types have different techniques for feature extraction. Hence in this chapter, we focus on various feature engineering techniques and strategies for the following major data types.

- Numeric data
- Categorical data
- Text data
- Temporal data
- Image data

Subsequent sections in this chapter focus on dealing with these diverse data types and specific techniques which can be applied to engineer features. You can use them as a reference and guidebook for engineering features from your own datasets in the future.

Another aspect into feature engineering has recently gained prominence. Here, you do not use hand-crafted features but, make the machine itself try to detect patterns and extract useful data representations from the raw data, which can be used as features. This process is also known as auto feature generation. Deep Learning has proved to be extremely effective in this area and neural network architectures like convolutional neural networks (CNNs), recurrent neural networks (RNNs), and Long Short Term Memory networks (LSTMs) are extensively used for auto feature engineering and extraction. Let's dive into the world of feature engineering now with some real-world datasets and examples.

## Feature Engineering on Numeric Data

Numeric data, fields, variables, or features typically represent data in the form of scalar information that denotes an observation, recording, or measurement. Of course, numeric data can also be represented as a vector of scalars where each specific entity in the vector is a numeric data point in itself. Integers and floats are the most common and widely used numeric data types. Besides this, numeric data is perhaps the easiest to process and is often used directly by Machine Learning models. If you remember we have talked about numeric data previously in the “Data Description” section in Chapter 3.

Even though numeric data can be directly fed into Machine Learning models, you would still need to engineer features that are relevant to the scenario, problem, and domain before building a model. Hence the need for feature engineering remains. Important aspects of numeric features include feature scale and distribution and you will observe some of these aspects in the examples in this section. In some scenarios, we need to apply specific transformations to change the scale of numeric values and in other scenarios we need to change the overall distribution of the numeric values, like transforming a skewed distribution to a normal distribution.

The code used for this section is available in the code files for this chapter. You can load `feature_engineering_numeric.py` directly and start running the examples or use the jupyter notebook, `Feature Engineering on Numeric Data.ipynb`, for a more interactive experience. Before we begin, let’s load the following dependencies and configuration settings.

```
In [1]: import pandas as pd
...: import matplotlib.pyplot as plt
...: import matplotlib as mpl
...: import numpy as np
...: import scipy.stats as spstats
...:
...: %matplotlib inline
...: mpl.style.reload_library()
...: mpl.style.use('classic')
...: mpl.rcParams['figure.facecolor'] = (1, 1, 1, 0)
...: mpl.rcParams['figure.figsize'] = [6.0, 4.0]
...: mpl.rcParams['figure.dpi'] = 100
```

Now that we have the initial dependencies loaded, let’s look at some ways to engineer features from numeric data in the following sections.

### Raw Measures

Just like we mentioned earlier, numeric features can be directly fed to Machine Learning models often since they are in a format which can be easily understood, interpreted, and operated on. Raw measures typically indicated using numeric variables directly as features without any form of transformation or engineering. Typically these features can indicate values or counts.

## Values

Usually, scalar values in its raw form indicate a specific measurement, metric, or observation belonging to a specific variable or field. The semantics of this field is usually obtained from the field name itself or a data dictionary if present. Let's load a dataset now about Pokémon! This dataset is also available on Kaggle. If you do not know, Pokémon is a huge media franchise surrounding fictional characters called Pokémon which stands for pocket monsters. In short, you can think of them as fictional animals with superpowers! The following snippet gives us an idea about this dataset.

```
In [2]: pke_df = pd.read_csv('datasets/Pokemon.csv', encoding='utf-8')
...: pke_df.head()
```

Out[2]:

	#	Name	Type 1	Type 2	Total	HP	Attack	Defense	Sp. Atk	Sp. Def	Speed	Generation	Legendary
0	1	Bulbasaur	Grass	Poison	318	45	49	49	65	65	45	1	False
1	2	Ivysaur	Grass	Poison	405	60	62	63	80	80	60	1	False
2	3	Venusaur	Grass	Poison	525	80	82	83	100	100	80	1	False
3	3	VenusaurMega Venusaur	Grass	Poison	625	80	100	123	122	120	80	1	False
4	4	Charmander	Fire	NaN	309	39	52	43	60	50	65	1	False

**Figure 4-3.** Raw data from the Pokémon dataset

If you observe the dataset depicted in Figure 4-3, there are several attributes there which represent numeric raw values which can be used directly. The following snippet depicts some of these features with more emphasis.

```
In [3]: pke_df[['HP', 'Attack', 'Defense']].head()
Out[3]:
```

	HP	Attack	Defense
0	45	49	49
1	60	62	63
2	80	82	83
3	80	100	123
4	39	52	43

You can directly use these attributes as features that are depicted in the previous dataframe. These include each Pokémon's HP (Hit Points), Attack, and Defense stats. In fact, we can also compute some basic statistical measures on these fields using the following code.

```
In [4]: pke_df[['HP', 'Attack', 'Defense']].describe()
Out[4]:
```

	HP	Attack	Defense
count	800.000000	800.000000	800.000000
mean	69.258750	79.001250	73.842500
std	25.534669	32.457366	31.183501
min	1.000000	5.000000	5.000000
25%	50.000000	55.000000	50.000000
50%	65.000000	75.000000	70.000000
75%	80.000000	100.000000	90.000000
max	255.000000	190.000000	230.000000

We can see multiple statistical measures like count, average, standard deviation, and quartiles for each of the numeric features in this output. Try plotting their distributions if possible!

## Counts

Raw numeric measures can also indicate counts, frequencies and occurrences of specific attributes. Let's look at a sample of data from the million-song dataset, which depicts counts or frequencies of songs that have been heard by various users.

```
In [5]: popsong_df = pd.read_csv('datasets/song_views.csv', encoding='utf-8')
...: popsong_df.head(10)
```

Out[5]:

	user_id	song_id	title	listen_count
0	b6b799f34a204bd928ea014c243ddad6d0be4f8f	SOBONKR12A58A7A7E0	You're The One	2
1	b41ead730ac14f6b6717b9cf8859d5579f3f8d4d	SOBONKR12A58A7A7E0	You're The One	0
2	4c84359a164b161496d05282707cecbd50adbfc4	SOBONKR12A58A7A7E0	You're The One	0
3	779b5908593756abb6ff7586177c966022668b06	SOBONKR12A58A7A7E0	You're The One	0
4	dd88ea94f605a63d9fc37a214127e3f00e85e42d	SOBONKR12A58A7A7E0	You're The One	0
5	68f0359a2f1cedb0d15c98d88017281db79f9bc6	SOBONKR12A58A7A7E0	You're The One	0
6	116a4c95d63623a967edf2f3456c90ebb1964e6f	SOBONKR12A58A7A7E0	You're The One	17
7	45544491ccfc0b0803c34f201a6287ed4e30f8	SOBONKR12A58A7A7E0	You're The One	0
8	e701a24d9b6c59f5ac37ab28462ca82470e27cfb	SOBONKR12A58A7A7E0	You're The One	68
9	edc8b7b1fd592a3b69c3d823a742e1a064abec95	SOBONKR12A58A7A7E0	You're The One	0

**Figure 4-4.** Song listen counts as a numeric feature

We can see that the `listen_count` field in the data depicted in Figure 4-4 can be directly used as a count/frequency based numeric feature.

## Binarization

Often raw numeric frequencies or counts are not necessary in building models especially with regard to methods applied in building recommender engines. For example if I want to know if a person is interested or has listened to a particular song, I do not need to know the total number of times he/she has listened to the same song. I am more concerned about the various songs he/she has listened to. In this case, a binary feature is preferred as opposed to a count based feature. We can binarize our `listen_count` field from our earlier dataset in the following way.

```
In [6]: watched = np.array(popsong_df['listen_count'])
...: watched[watched >= 1] = 1
...: popsong_df['watched'] = watched
```

You can also use `scikit-learn`'s `Binarizer` class here from its preprocessing module to perform the same task instead of `numpy` arrays, as depicted in the following code.

```
In [7]: from sklearn.preprocessing import Binarizer
...:
...: bn = Binarizer(threshold=0.9)
...: pd_watched = bn.transform([popsong_df['listen_count']])[0]
...: popsong_df['pd_watched'] = pd_watched
...: popsong_df.head(11)
```

Out[7]:

	user_id	song_id	title	listen_count	watched	pd_watched
0	b6b799f34a204bd928ea014c243ddad6d0be4f8f	SOBONKR12A58A7A7E0	You're The One	2	1	1
1	b41ead730ac14f6b6717b9cf8859d5579f3f8d4d	SOBONKR12A58A7A7E0	You're The One	0	0	0
2	4c84359a164b161496d05282707cecbd50adbfc4	SOBONKR12A58A7A7E0	You're The One	0	0	0
3	779b5908593756abb6ff7586177c966022668b06	SOBONKR12A58A7A7E0	You're The One	0	0	0
4	dd88ea94f605a63d9fc37a214127e3f00e85e42d	SOBONKR12A58A7A7E0	You're The One	0	0	0
5	68f0359a2f1cedb0d15c98d88017281db79f9bc6	SOBONKR12A58A7A7E0	You're The One	0	0	0
6	116a4c95d63623a967edf2f3456c90ebbf964e6f	SOBONKR12A58A7A7E0	You're The One	17	1	1
7	45544491ccfc0c0b0803c34f201a6287ed4e30f8	SOBONKR12A58A7A7E0	You're The One	0	0	0
8	e701a24d9b6c59f5ac37ab28462ca82470e27cfb	SOBONKR12A58A7A7E0	You're The One	68	1	1
9	edc8b7b1fd592a3b69c3d823a742e1a064abec95	SOBONKR12A58A7A7E0	You're The One	0	0	0
10	fb41d1c374d093ab643ef3bcd70eeb258d479076	SOBONKR12A58A7A7E0	You're The One	1	1	1

Figure 4-5. Binarizing song counts

You can clearly see from Figure 4-5 that both the methods have produced the same results depicted in features `watched` and `pd_watched`. Thus, we have the song listen counts as a binarized feature indicating if the song was listened to or not by each user.

## Rounding

Often when dealing with numeric attributes like proportions or percentages, we may not need values with a high amount of precision. Hence it makes sense to round off these high precision percentages into numeric integers. These integers can then be directly used as raw numeric values or even as categorical (discrete-class based) features. Let's try applying this concept in a dummy dataset depicting store items and their popularity percentages.

```
In [8]: items_popularity = pd.read_csv('datasets/item_popularity.csv', encoding='utf-8')
...: # rounding off percentages
...: items_popularity['popularity_scale_10'] =
...:     np.array(np.round((items_popularity['pop_percent'] * 10)), dtype='int')
...: items_popularity['popularity_scale_100'] =
...:     np.array(np.round((items_popularity['pop_percent'] * 100)), dtype='int')
...: items_popularity
```

Out[8]:

	item_id	pop_percent	popularity_scale_10	popularity_scale_100
0	it_01345	0.98324	10	98
1	it_03431	0.56123	6	56
2	it_04572	0.12098	1	12
3	it_98021	0.35476	4	35

4	it_01298	0.92101	9	92
5	it_90120	0.81212	8	81
6	it_10123	0.56502	6	57

Thus after our rounding operations, you can see the new features in the data depicted in the previous dataframe. Basically we tried two forms of rounding. The features depict the item popularities now both on a scale of 1-10 and on a scale of 1-100. You can use these values both as numerical or categorical features based on the scenario and problem.

## Interactions

A model is usually built in such a way that we try to model the output responses (discrete classes or continuous values) as a function of the input feature variables. For example, a simple linear regression equation can be depicted as  $y = c_1x_1 + c_2x_2 + \dots + c_nx_n$  where the input features are depicted by variables  $\{x_1, x_2, \dots, x_n\}$  having weights or coefficients of  $\{c_1, c_2, \dots, c_n\}$  respectively and the goal is the predict response  $y$ . In this case, this simple linear model depicts the relationship between the output and inputs, purely based on the individual, separate input features.

However, often in several real-world datasets and scenarios, it makes sense to also try to capture the interactions between these feature variables as a part of the input feature set. A simple depiction of the extension of the above linear regression formulation with interaction features would be  $y = c_1x_1 + c_2x_2 + \dots + c_nx_n + c_{11}x_1^2 + c_{22}x_2^2 + c_{12}x_1x_2 + \dots$  where features like  $\{x_1x_2, x_1^2, \dots\}$  denote the interaction features. Let's try engineering some interaction features on our Pokémon dataset now.

```
In [9]: atk_def = poke_df[['Attack', 'Defense']]
...: atk_def.head()
```

```
Out[9]:
   Attack  Defense
0      49       49
1      62       63
2      82       83
3     100      123
4      52       43
```

We can see in this output, the two numeric features depicting Pokémon attack and defense. The following code helps us build interaction features from these two features. We will build features up to the second degree using the `PolynomialFeatures` class from `scikit-learn`'s API.

```
In [10]: from sklearn.preprocessing import PolynomialFeatures
...:
...: pf = PolynomialFeatures(degree=2, interaction_only=False, include_bias=False)
...: res = pf.fit_transform(atk_def)
...: res
```

```
Out[10]:
array([[ 49.,   49., 2401., 2401., 2401.],
       [ 62.,   63., 3844., 3906., 3969.],
       [ 82.,   83., 6724., 6806., 6889.],
       ...,
       [110.,   60., 12100., 6600., 3600.],
       [160.,   60., 25600., 9600., 3600.],
       [110.,  120., 12100., 13200., 14400.]])
```



We can clearly see from this output that we have a total of five features including the new interaction features. We can see the degree of each feature in the matrix, using the following snippet.

```
In [11]: pd.DataFrame(pf.powers_, columns=['Attack_degree', 'Defense_degree'])
Out[11]:
  Attack_degree  Defense_degree
0              1                0
1              0                1
2              2                0
3              1                1
4              0                2
```

Now that we know what each feature actually represented from the degrees depicted, we can assign a name to each feature as follows to get the updated feature set.

```
In [12]: intr_features = pd.DataFrame(res,
  ....:                               columns=['Attack', 'Defense',
  ....:                                       'Attack^2', 'Attack x Defense', 'Defense^2'])
  ....: intr_features.head(5)
Out[12]:
  Attack  Defense  Attack^2  Attack x Defense  Defense^2
0   49.0    49.0    2401.0         2401.0    2401.0
1   62.0    63.0    3844.0         3906.0    3969.0
2   82.0    83.0    6724.0         6806.0    6889.0
3  100.0   123.0   10000.0        12300.0   15129.0
4   52.0    43.0    2704.0         2236.0    1849.0
```

Thus we can see our original and interaction features in Figure 4-10. The `fit_transform(...)` API function from `scikit-learn` is useful to build a feature engineering representation object on the training data, which can be reused on new data during model predictions by calling on the `transform(...)` function. Let's take some sample new observations for Pokémon attack and defense features and try to transform them using this same mechanism.

```
In [13]: new_df = pd.DataFrame([[95, 75],[121, 120], [77, 60]],
  ....:                          columns=['Attack', 'Defense'])
  ....: new_df
Out[13]:
  Attack  Defense
0     95     75
1    121    120
2     77     60
```

We can now use the `pf` object that we created earlier and transform these input features to give us the interaction features as follows.

```
In [14]: new_res = pf.transform(new_df)
  ....: new_intr_features = pd.DataFrame(new_res,
  ....:                                   columns=['Attack', 'Defense',
  ....:                                           'Attack^2', 'Attack x Defense', 'Defense^2'])
  ....: new_intr_features
Out[14]:
```

	Attack	Defense	Attack^2	Attack x Defense	Defense^2
0	95.0	75.0	9025.0	7125.0	5625.0
1	121.0	120.0	14641.0	14520.0	14400.0
2	77.0	60.0	5929.0	4620.0	3600.0

Thus you can see that we have successfully obtained the necessary interaction features for the new dataset. Try building interaction features on three or more features now!

## Binning

Often when working with numeric data, you might come across features or attributes which depict raw measures such as values or frequencies. In many cases, often the distributions of these attributes are skewed in the sense that some sets of values will occur a lot and some will be very rare. Besides that, there is also the added problem of varying range of these values. Suppose we are talking about song or video view counts. In some cases, the view counts will be abnormally large and in some cases very small. Directly using these features in modeling might cause issues. Metrics like similarity measures, cluster distances, regression coefficients and more might get adversely affected if we use raw numeric features having values which range across multiple orders of magnitude. There are various ways to engineer features from these raw values so we can these issues. These methods include transformations, scaling and binning/quantization.

In this section, we will talk about binning which is also known as quantization. The operation of binning is used for transforming continuous numeric values into discrete ones. These discrete numbers can be thought of as bins into which the raw values or numbers are binned or grouped into. Each bin represents a specific degree of intensity and has a specific range of values which must fall into that bin. There are various ways of binning data which include fixed-width and adaptive binning. Specific techniques can be employed for each binning process. We will use a dataset extracted from the 2016 FreeCodeCamp Developer/Coder survey which talks about various attributes pertaining to coders and software developers. You can check it out yourself at <https://github.com/freeCodeCamp/2016-new-coder-survey> for more details. Let's load the dataset and take a peek at some interesting attributes.

```
In [15]: fcc_survey_df = pd.read_csv('datasets/fcc_2016_coder_survey_subset.csv',
...:                               encoding='utf-8')
...: fcc_survey_df[['ID.x', 'EmploymentField', 'Age', 'Income']].head()
```

Out[15]:

	ID.x	EmploymentField	Age	Income
0	cef35615d61b202f1dc794ef2746df14	office and administrative support	28.0	32000.0
1	323e5a113644d18185c743c241407754	food and beverage	22.0	15000.0
2	b29a1027e5cd062e654a63764157461d	finance	19.0	48000.0
3	04a11e4bcb573a1261eb0d9948d32637	arts, entertainment, sports, or media	26.0	43000.0
4	9368291c93d5d5f5c8cdb1a575e18bec	education	20.0	6000.0

**Figure 4-6.** Important attributes from the FCC coder survey dataset

The dataframe depicted in Figure 4-6 shows us some interesting attributes of the coder survey dataset, some of which we will be analyzing in this section. The ID.x variable is basically a unique identifier for each coder/developer who took the survey and the other fields are pretty self-explanatory.

## Fixed-Width Binning

In fixed-width binning, as the name indicates, we have specific fixed widths for each of the bins, which are usually pre-defined by the user analyzing the data. Each bin has a pre-fixed range of values which should be assigned to that bin on the basis of some business or custom logic, rules, or necessary transformations.

Binning based on rounding is one of the ways, where you can use the rounding operation that we discussed earlier to bin raw values. Let's consider the Age feature from the coder survey dataset. The following code shows the distribution of developer ages who took the survey.

```
In [16]: fig, ax = plt.subplots()
...: fcc_survey_df['Age'].hist(color='#A9C5D3')
...: ax.set_title('Developer Age Histogram', fontsize=12)
...: ax.set_xlabel('Age', fontsize=12)
...: ax.set_ylabel('Frequency', fontsize=12)
```

Out[16]:

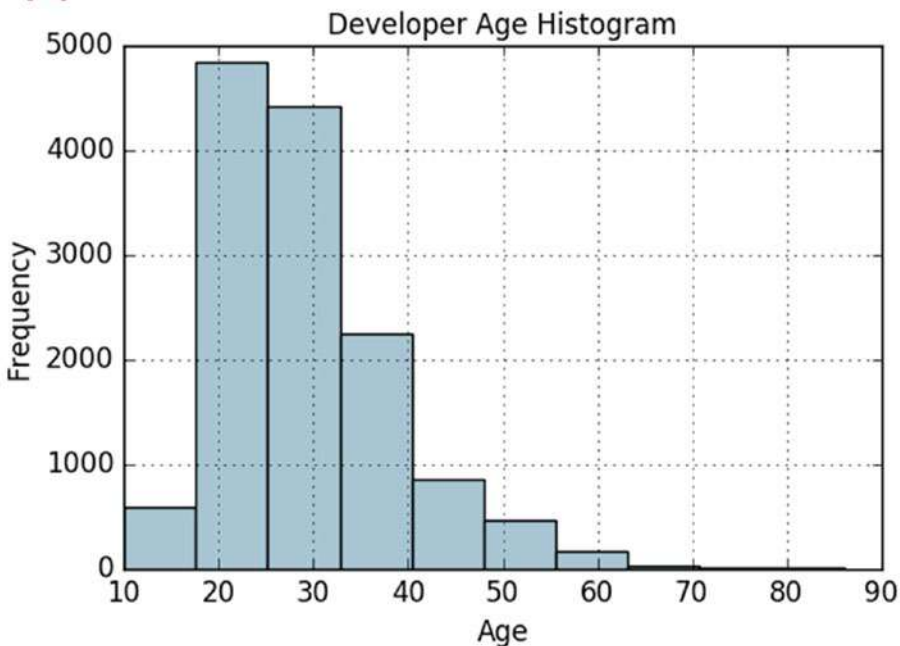

**Figure 4-7.** Histogram depicting developer age distribution

The histogram in Figure 4-7 depicts the distribution of developer ages, which is slightly right skewed as expected. Let's try to assign these raw age values into specific bins based on the following logic.

```
Age Range: Bin
-----
0 - 9 : 0
10 - 19 : 1
20 - 29 : 2
30 - 39 : 3
```

```

40 - 49 : 4
50 - 59 : 5
60 - 69 : 6
... and so on

```

We can easily do this using what we learned in the “Rounding” section earlier where we round off these raw age values by taking the floor value after dividing it by 10. The following code depicts the same.

```

In [17]: fcc_survey_df['Age_bin_round'] = np.array(np.floor(np.array(fcc_survey_df['Age']) /
...: fcc_survey_df[['ID.x', 'Age', 'Age_bin_round']].iloc[1071:1076]
Out[17]:

```

	ID.x	Age	Age_bin_round
1071	6a02aa4618c99fdb3e24de522a099431	17.0	1.0
1072	f0e5e47278c5f248fe861c5f7214c07a	38.0	3.0
1073	6e14f6d0779b7e424fa3fdd9e4bd3bf9	21.0	2.0
1074	c2654c07dc929cdf3dad4d1aec4ffbb3	53.0	5.0
1075	f07449fc9339b2e57703ec7886232523	35.0	3.0

We take a specific slice of the dataset (rows 1071-1076) to depict users of varying ages. You can see the corresponding bins for each age have been assigned based on rounding. But what if we need more flexibility? What if I want to decide and fix the bin widths myself?

Binning based on custom ranges is the answer to the all our questions about fixed-width binning, some of which I just mentioned. Let’s define some custom age ranges for binning developer ages using the following scheme.

```

Age Range : Bin
-----
0 - 15 : 1
16 - 30 : 2
31 - 45 : 3
46 - 60 : 4
61 - 75 : 5
75 - 100 : 6

```

Based on this custom binning scheme, we will now label the bins for each developer age value with the help of the following code. We will store both the bin range as well as the corresponding label.

```

In [18]: bin_ranges = [0, 15, 30, 45, 60, 75, 100]
...: bin_names = [1, 2, 3, 4, 5, 6]
...: fcc_survey_df['Age_bin_custom_range'] = pd.cut(np.array(fcc_survey_df['Age']),
...: bins=bin_ranges)
...: fcc_survey_df['Age_bin_custom_label'] = pd.cut(np.array(fcc_survey_df['Age']),
...: bins=bin_ranges, labels=bin_names)
...: fcc_survey_df[['ID.x', 'Age', 'Age_bin_round',
...: 'Age_bin_custom_range', 'Age_bin_custom_label']].iloc[1071:1076]

```

Out[18]:

	ID.x	Age	Age_bin_round	Age_bin_custom_range	Age_bin_custom_label
1071	6a02aa4618c99fdb3e24de522a099431	17.0	1.0	(15, 30]	2
1072	f0e5e47278c5f248fe861c5f7214c07a	38.0	3.0	(30, 45]	3
1073	6e14f6d0779b7e424fa3fdd9e4bd3bf9	21.0	2.0	(15, 30]	2
1074	c2654c07dc929cdf3dad4d1aec4ffb3	53.0	5.0	(45, 60]	4
1075	f07449fc9339b2e57703ec7886232523	35.0	3.0	(30, 45]	3

**Figure 4-8.** Custom age binning for developer ages

We can see from the dataframe output in Figure 4-8 that the custom bins based on our scheme have been assigned for each developer's age. Try out some of your own binning schemes!

## Adaptive Binning

So far, we have decided the bin width and ranges in fixed-width binning. However, this technique can lead to irregular bins that are not uniform based on the number of data points or values which fall in each bin. Some of the bins might be densely populated and some of them might be sparsely populated or even be empty! Adaptive binning is a safer and better approach where we use the data distribution itself to decide what should be the appropriate bins.

Quantile based binning is a good strategy to use for adaptive binning. Quantiles are specific values or cut-points which help in partitioning the continuous valued distribution of a specific numeric field into discrete contiguous bins or intervals. Thus, *q-Quantiles* help in partitioning a numeric attribute into *q* equal partitions. Popular examples of quantiles include the *2-Quantile* known as the median which divides the data distribution into two equal bins, *4-Quantiles* known as the quartiles, which divide the data into four equal bins and *10-Quantiles* also known as the deciles which create 10 equal width bins. Let's now look at a slice of data pertaining to developer income values in our coder survey dataset.

```
In [19]: fcc_survey_df[['ID.x', 'Age', 'Income']].iloc[4:9]
Out[19]:
```

	ID.x	Age	Income
4	9368291c93d5d5f5c8cdb1a575e18bec	20.0	6000.0
5	dd0e77eab9270e4b67c19b0d6bbf621b	34.0	40000.0
6	7599c0aa0419b59fd11ffede98a3665d	23.0	32000.0
7	6dff182db452487f07a47596f314bddc	35.0	40000.0
8	9dc233f8ed1c6eb2432672ab4bb39249	33.0	80000.0

The slice of data depicted by the dataframe shows us the income values for each developer in our dataset. Let's look at the whole data distribution for this Income variable now using the following code.

```
In [20]: fig, ax = plt.subplots()
...: fcc_survey_df['Income'].hist(bins=30, color='#A9C5D3')
...: ax.set_title('Developer Income Histogram', fontsize=12)
...: ax.set_xlabel('Developer Income', fontsize=12)
...: ax.set_ylabel('Frequency', fontsize=12)
```

Out[20]:

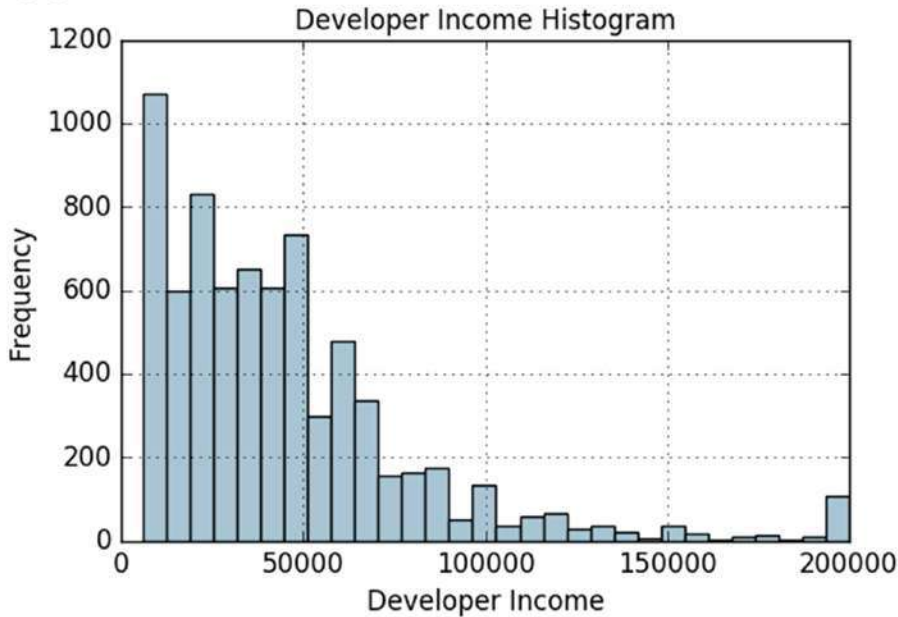

**Figure 4-9.** Histogram depicting developer income distribution

We can see from the distribution depicted in Figure 4-9 that as expected there is a right skew with lesser developers earning more money and vice versa. Let's take a *4-Quantile* or a quartile based adaptive binning scheme. The following snippet helps us obtain the income values that fall on the four quartiles in the distribution.

```
In [21]: quantile_list = [0, .25, .5, .75, 1.]
...: quantiles = fcc_survey_df['Income'].quantile(quantile_list)
...: quantiles
Out[21]:
0.00    6000.0
0.25   20000.0
0.50   37000.0
0.75   60000.0
1.00  200000.0
```

To visualize the quartiles obtained in this output better, we can plot them in our data distribution using the following code snippet.

```
In [22]: fig, ax = plt.subplots()
...: fcc_survey_df['Income'].hist(bins=30, color='#A9C5D3')
...:
...: for quantile in quantiles:
...:     qv1 = plt.axvline(quantile, color='r')
...: ax.legend([qv1], ['Quantiles'], fontsize=10)
...:
...: ax.set_title('Developer Income Histogram with Quantiles', fontsize=12)
...: ax.set_xlabel('Developer Income', fontsize=12)
...: ax.set_ylabel('Frequency', fontsize=12)
```

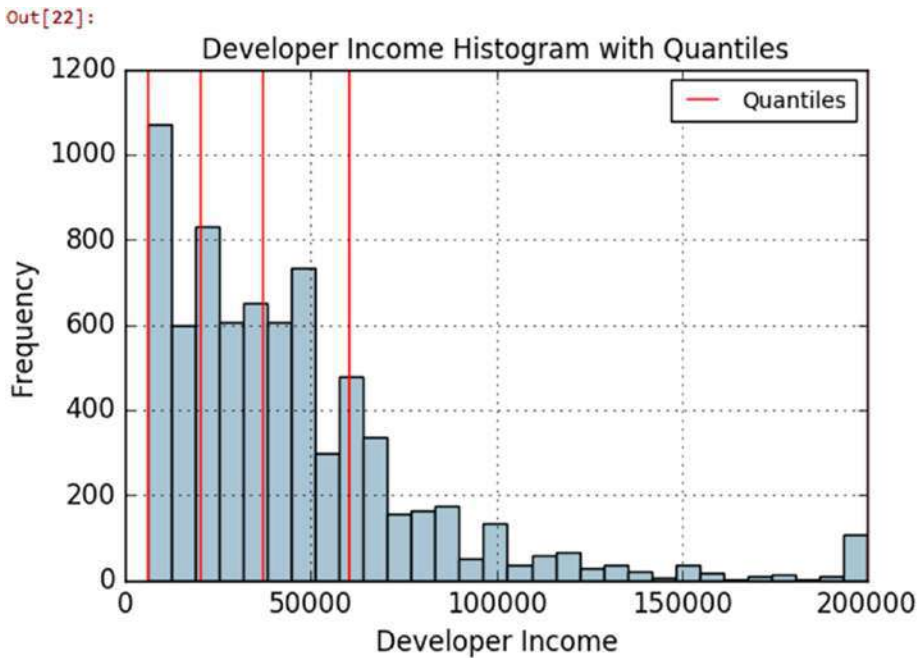

**Figure 4-10.** Histogram depicting developer income distribution with quartile values

The 4-Quantile values for the income attribute are depicted by red vertical lines in Figure 4-10. Let’s now use quantile binning to bin each of the developer income values into specific bins using the following code.

```
In [23]: quantile_labels = ['0-25Q', '25-50Q', '50-75Q', '75-100Q']
...: fcc_survey_df['Income_quantile_range'] = pd.qcut(fcc_survey_df['Income'],
...: q=quantile_list)
...: fcc_survey_df['Income_quantile_label'] = pd.qcut(fcc_survey_df['Income'],
...: q=quantile_list,
...: labels=quantile_labels)
...: fcc_survey_df[['ID.x', 'Age', 'Income',
...: 'Income_quantile_range', 'Income_quantile_label']].iloc[4:9]
```

Out[23]:

	ID.x	Age	Income	Income_quantile_range	Income_quantile_label
4	9368291c93d5d5f5c8cdb1a575e18bec	20.0	6000.0	(5999.999, 20000.0]	0-25Q
5	dd0e77eab9270e4b67c19b0d6bbf621b	34.0	40000.0	(37000.0, 60000.0]	50-75Q
6	7599c0aa0419b59fd11ffede98a3665d	23.0	32000.0	(20000.0, 37000.0]	25-50Q
7	6dff182db452487f07a47596f314bdbc	35.0	40000.0	(37000.0, 60000.0]	50-75Q
8	9dc233f8ed1c6eb2432672ab4bb39249	33.0	80000.0	(60000.0, 200000.0]	75-100Q

**Figure 4-11.** Quantile based bin ranges and labels for developer incomes

The result dataframe depicted in Figure 4-11 clearly shows the quantile based bin range and corresponding label assigned for each developer income value in the `Income_quantile_range` and `Income_quantile_labels` features, respectively.

## Statistical Transformations

Let's look at a different strategy of feature engineering on numerical data by using statistical or mathematical transformations. In this section, we will look at the Log transform as well as the Box-Cox transform. Both of these transform functions belong to the Power Transform family of functions. These functions are typically used to create monotonic data transformations, but their main significance is that they help in stabilizing variance, adhering closely to the normal distribution and making the data independent of the mean based on its distribution. Several transformations are also used as a part of feature scaling, which we cover in a future section.

### Log Transform

The log transform belongs to the power transform family of functions. This function can be defined as  $y = \log_b(x)$  which reads as log of  $x$  to the base  $b$  is equal to  $y$ . This translates to  $b^y = x$ , which indicates as to what power must the base  $b$  be raised to in order to get  $x$ . The natural logarithm uses the base  $b = e$  where  $e = 2.71828$  popularly known as Euler's number. You can also use base  $b = 10$  used popularly in the decimal system. Log transforms are useful when applied to skewed distributions as they tend to expand the values which fall in the range of lower magnitudes and tend to compress or reduce the values which fall in the range of higher magnitudes. This tends to make the skewed distribution as normal-like as possible. Let's use log transform on our developer income feature from our coder survey dataset.

```
In [24]: fcc_survey_df['Income_log'] = np.log((1+ fcc_survey_df['Income']))
...: fcc_survey_df[['ID.x', 'Age', 'Income', 'Income_log']].iloc[4:9]
Out[24]:
```

	ID.x	Age	Income	Income_log
4	9368291c93d5d5f5c8cdb1a575e18bec	20.0	6000.0	8.699681
5	dd0e77eab9270e4b67c19b0d6bbf621b	34.0	40000.0	10.596660
6	7599c0aa0419b59fd11ffede98a3665d	23.0	32000.0	10.373522
7	6dff182db452487f07a47596f314bdc	35.0	40000.0	10.596660
8	9dc233f8ed1c6eb2432672ab4bb39249	33.0	80000.0	11.289794

The dataframe obtained in this output depicts the log transformed income feature in the `Income_log` field. Let's now plot the data distribution of this transformed feature using the following code.

```
In [25]: income_log_mean = np.round(np.mean(fcc_survey_df['Income_log']), 2)
...:
...: fig, ax = plt.subplots()
...: fcc_survey_df['Income_log'].hist(bins=30, color='#A9C5D3')
...: plt.axvline(income_log_mean, color='r')
...: ax.set_title('Developer Income Histogram after Log Transform', fontsize=12)
...: ax.set_xlabel('Developer Income (log scale)', fontsize=12)
...: ax.set_ylabel('Frequency', fontsize=12)
...: ax.text(11.5, 450, r'\mu$='+str(income_log_mean), fontsize=10)
```



Out[25]:

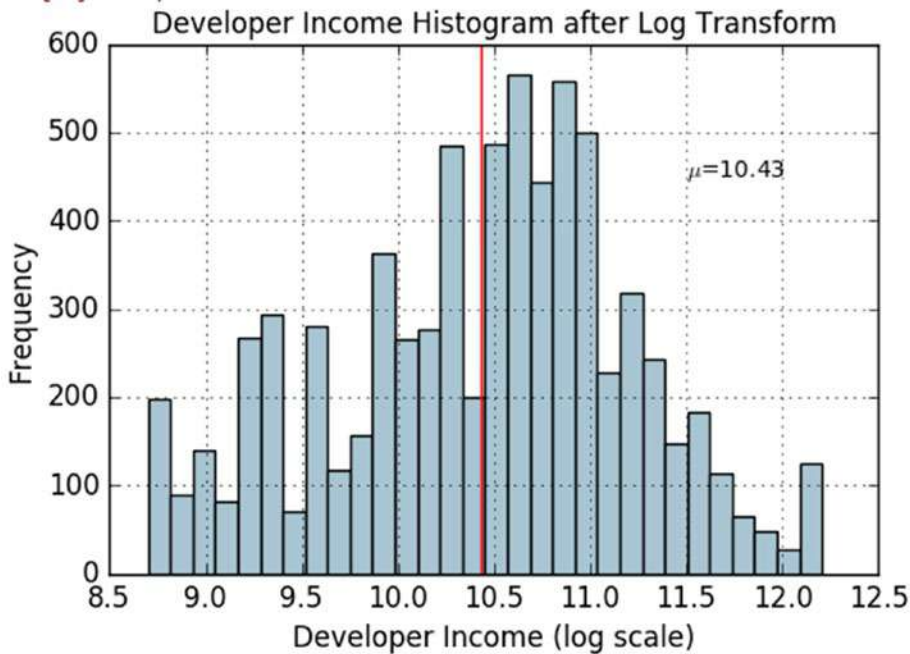

**Figure 4-12.** Histogram depicting developer income distribution after log transform

Thus we can clearly see that the original developer income distribution that was right skewed in Figure 4-10 is more Gaussian or normal-like in Figure 4-12 after applying the log transform.

## Box-Cox Transform

Let's now look at the Box-Cox transform, another popular function belonging to the power transform family of functions. This function has a prerequisite that the numeric values to be transformed must be positive (similar to what log transform expects). In case they are negative, shifting using a constant value helps. Mathematically, the Box-Cox transform function can be defined as,

$$y = f(x, \lambda) = x^\lambda = \begin{cases} \frac{x^\lambda - 1}{\lambda} & \text{for } \lambda > 0 \\ \log_e(x) & \text{for } \lambda = 0 \end{cases}$$

Such that the resulted transformed output  $y$  is a function of input  $x$  and transformation parameter  $\lambda$  such that when  $\lambda = 0$ , the resultant transform is the natural log transform, which we discussed earlier. The optimal value of  $\lambda$  is usually determined using a maximum likelihood or log-likelihood estimation. Let's apply the Box-Cox transform on our developer income feature. To do this, first we get the optimal lambda value from the data distribution by removing the non-null values using the following code.

```
In [26]: # get optimal lambda value from non null income values
...: income = np.array(fcc_survey_df['Income'])
...: income_clean = income[~np.isnan(income)]
...: l, opt_lambda = spstats.boxcox(income_clean)
...: print('Optimal lambda value:', opt_lambda)
Optimal lambda value: 0.117991239456
```

Now that we have obtained the optimal  $\lambda$  value, let's use the Box-Cox transform for two values of  $\lambda$  such that  $\lambda = 0$  &  $\lambda = \lambda_{optimal}$  and transform the raw numeric values pertaining to developer incomes.

```
In [27]: fcc_survey_df['Income_boxcox_lambda_0'] = spstats.boxcox((1+fcc_survey_df['Income']),
...:                                                                lmbda=0)
...: fcc_survey_df['Income_boxcox_lambda_opt'] = spstats.boxcox(fcc_survey_df['Income'],
...:                                                                lmbda=opt_lambda)
...: fcc_survey_df[['ID.x', 'Age', 'Income', 'Income_log',
...:                 'Income_boxcox_lambda_0', 'Income_boxcox_lambda_opt']].iloc[4:9]
```

Out[27]:

	ID.x	Age	Income	Income_log	Income_boxcox_lambda_0	Income_boxcox_lambda_opt
4	9368291c93d5d5f5c8c8db1a575e18bec	20.0	6000.0	8.699681	8.699681	15.180668
5	dd0e77eab9270e4b67c19b0d6bbf621b	34.0	40000.0	10.596660	10.596660	21.115342
6	7599c0aa0419b59fd11ffede98a3665d	23.0	32000.0	10.373522	10.373522	20.346420
7	6dff182db452487f07a47596f314bddc	35.0	40000.0	10.596660	10.596660	21.115342
8	9dc233f8ed1c6eb2432672ab4bb39249	33.0	80000.0	11.289794	11.289794	23.637131

**Figure 4-13.** Dataframe depicting developer income distribution after box-cox transform

The dataframe obtained in the output shown in Figure 4-13 depicts the income feature after applying the Box-Cox transform for  $\lambda = 0$  and  $\lambda = \lambda_{optimal}$  in the `Income_boxcox_lambda_0` and `Income_boxcox_lambda_opt` fields respectively. Also as expected, the `Income_log` field has the same values as the Box-Cox transform with  $\lambda = 0$ . Let's now plot the data distribution for the Box-Cox transformed developer values with optimal lambda. See Figure 4-14.

```
In [30]: income_boxcox_mean = np.round(np.mean(fcc_survey_df['Income_boxcox_lambda_opt']), 2)
...:
...: fig, ax = plt.subplots()
...: fcc_survey_df['Income_boxcox_lambda_opt'].hist(bins=30, color='#A9C5D3')
...: plt.axvline(income_boxcox_mean, color='r')
...: ax.set_title('Developer Income Histogram after Box-Cox Transform', fontsize=12)
...: ax.set_xlabel('Developer Income (Box-Cox transform)', fontsize=12)
...: ax.set_ylabel('Frequency', fontsize=12)
...: ax.text(24, 450, r'$\mu$='+str(income_boxcox_mean), fontsize=10)
```

Out[28]:

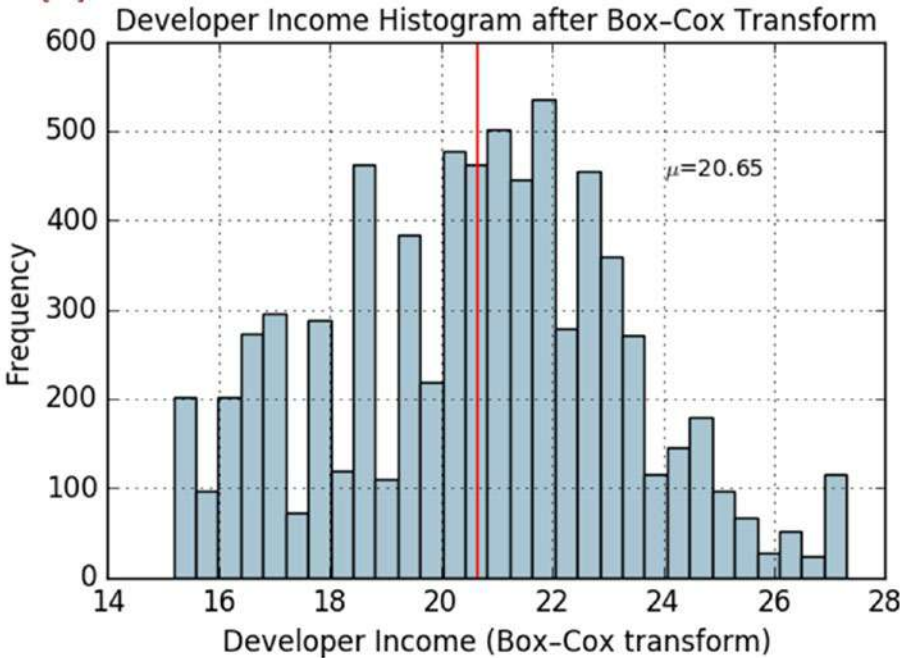

**Figure 4-14.** Histogram depicting developer income distribution after box-cox transform ( $\lambda = \lambda_{optimal}$ )

The distribution of the transformed numeric values for developer income after the Box-Cox distribution also look similar to the one we had obtained after the Log transform such that it is more normal-like and the extreme right skew that was present in the raw data has been minimized here.

## Feature Engineering on Categorical Data

So far, we have been working on continuous numeric data and you have also seen various techniques for engineering features from the same. We will now look at another structured data type, which is categorical data. Any attribute or feature that is categorical in nature represents discrete values that belong to a specific finite set of categories or classes. Category or class labels can be text or numeric in nature. Usually there are two types of categorical variables—nominal and ordinal.

Nominal categorical features are such that there is no concept of ordering among the values, i.e., it does not make sense to sort or order them. Movie or video game genres, weather seasons, and country names are some examples of nominal attributes. Ordinal categorical variables can be ordered and sorted on the basis of their values and hence these values have specific significance such that their order makes sense. Examples of ordinal attributes include clothing size, education level, and so on.

In this section, we look at various strategies and techniques for transforming and encoding categorical features and attributes. The code used for this section is available in the code files for this chapter. You can load `feature_engineering_categorical.py` directly and start running the examples or use the jupyter notebook, `Feature Engineering on Categorical Data.ipynb`, for a more interactive experience. Before we begin, let's load the following dependencies.

```
In [1]: import pandas as pd
...: import numpy as np
```

Once you have these dependencies loaded, let's get started and engineer some features from categorical data.

## Transforming Nominal Features

Nominal features or attributes are categorical variables that usually have a finite set of distinct discrete values. Often these values are in string or text format and Machine Learning algorithms cannot understand them directly. Hence usually you might need to transform these features into a more representative numeric format. Let's look at a new dataset pertaining to video game sales. This dataset is also available on Kaggle (<https://www.kaggle.com/gregorut/videogamesales>). We have downloaded a copy of this for your convenience. The following code helps us load this dataset and view some of the attributes of our interest.

```
In [2]: vg_df = pd.read_csv('datasets/vgsales.csv', encoding='utf-8')
...: vg_df[['Name', 'Platform', 'Year', 'Genre', 'Publisher']].iloc[1:7]
Out[2]:
```

	Name	Platform	Year	Genre	Publisher
1	Super Mario Bros.	NES	1985.0	Platform	Nintendo
2	Mario Kart	Wii	2008.0	Racing	Nintendo
3	Wii Sports Resort	Wii	2009.0	Sports	Nintendo
4	Pokemon Red/Pokemon Blue	GB	1996.0	Role-Playing	Nintendo
5	Tetris	GB	1989.0	Puzzle	Nintendo
6	New Super Mario Bros.	DS	2006.0	Platform	Nintendo

The dataset depicted in this dataframe shows us various attributes pertaining to video games. Features like Platform, Genre, and Publisher are nominal categorical variables. Let's now try to transform the video game Genre feature into a numeric representation. Do note here that this doesn't indicate that the transformed feature will be a numeric feature. It will still be a discrete valued categorical feature with numbers instead of text for each genre. The following code depicts the total distinct genre labels for video games.

```
In [3]: genres = np.unique(vg_df['Genre'])
...: genres
Out[3]:
array(['Action', 'Adventure', 'Fighting', 'Misc', 'Platform', 'Puzzle',
       'Racing', 'Role-Playing', 'Shooter', 'Simulation', 'Sports',
       'Strategy'], dtype=object)
```

This output tells us we have 12 distinct video game genres in our dataset. Let's transform this feature now using a mapping scheme in the following code.

```
In [4]: from sklearn.preprocessing import LabelEncoder
...:
...: gle = LabelEncoder()
...: genre_labels = gle.fit_transform(vg_df['Genre'])
...: genre_mappings = {index: label for index, label in enumerate(gle.classes_)}
...: genre_mappings
Out[4]:
{0: 'Action', 1: 'Adventure', 2: 'Fighting', 3: 'Misc',
 4: 'Platform', 5: 'Puzzle', 6: 'Racing', 7: 'Role-Playing',
 8: 'Shooter', 9: 'Simulation', 10: 'Sports', 11: 'Strategy'}
```

From the output, we can see that a mapping scheme has been generated where each genre value is mapped to a number with the help of the `LabelEncoder` object `gle`. The transformed labels are stored in the `genre_labels` value. Let's write it back to the original dataframe and view the results.

```
In [5]: vg_df['GenreLabel'] = genre_labels
...: vg_df[['Name', 'Platform', 'Year', 'Genre', 'GenreLabel']].iloc[1:7]
Out[5]:
```

	Name	Platform	Year	Genre	GenreLabel
1	Super Mario Bros.	NES	1985.0	Platform	4
2	Mario Kart Wii	Wii	2008.0	Racing	6
3	Wii Sports Resort	Wii	2009.0	Sports	10
4	Pokemon Red/Pokemon Blue	GB	1996.0	Role-Playing	7
5	Tetris	GB	1989.0	Puzzle	5
6	New Super Mario Bros.	DS	2006.0	Platform	4

The `GenreLabel` field depicts the mapped numeric labels for each of the `Genre` labels and we can clearly see that this adheres to the mappings that we generated earlier.

## Transforming Ordinal Features

Ordinal features are similar to nominal features except that order matters and is an inherent property with which we can interpret the values of these features. Like nominal features, even ordinal features might be present in text form and you need to map and transform them into their numeric representation. Let's now load our Pokémon dataset that we used earlier and look at the various values of the `Generation` attribute for each Pokémon.

```
In [6]: poke_df = pd.read_csv('datasets/Pokemon.csv', encoding='utf-8')
...: poke_df = poke_df.sample(random_state=1, frac=1).reset_index(drop=True)
...:
...: np.unique(poke_df['Generation'])
Out[6]: array(['Gen 1', 'Gen 2', 'Gen 3', 'Gen 4', 'Gen 5', 'Gen 6'], dtype=object)
```

We resample the dataset in this code just so we can get a good slice of data later on that represents all the distinct values which we are looking for. From this output we can see that there are a total of six generations of Pokémon. This attribute is definitely ordinal because Pokémon belonging to Generation 1 were introduced earlier in the video games and the television shows than Generation 2 and so on. Hence they have a sense of order among them. Unfortunately, since there is a specific logic or set of rules involved in case of each ordinal variable, there is no generic module or function to map and transform these features into numeric representations. Hence we need to hand-craft this using our own logic, which is depicted in the following code snippet.

```
In [7]: gen_ord_map = {'Gen 1': 1, 'Gen 2': 2, 'Gen 3': 3,
...:                  'Gen 4': 4, 'Gen 5': 5, 'Gen 6': 6}
...:
...: poke_df['GenerationLabel'] = poke_df['Generation'].map(gen_ord_map)
...: poke_df[['Name', 'Generation', 'GenerationLabel']].iloc[4:10]
Out[7]:
```

	Name	Generation	GenerationLabel
4	Octillery	Gen 2	2
5	Helioptile	Gen 6	6
6	Dialga	Gen 4	4

7	DeoxysDefense	Forme	Gen 3	3
8		Rapidash	Gen 1	1
9		Swanna	Gen 5	5

Thus, you can see that it is really easy to build your own transformation mapping scheme with the help of Python dictionaries and use the `map(...)` function from pandas to transform the ordinal feature.

## Encoding Categorical Features

We have mentioned several times in the past that Machine Learning algorithms usually work well with numerical values. You might now be wondering we already transformed and mapped the categorical variables into numeric representations in the previous sections so why would we need more levels of encoding again? The answer to this is pretty simple. If we directly fed these transformed numeric representations of categorical features into any algorithm, the model will essentially try to interpret these as raw numeric features and hence the notion of magnitude will be wrongly introduced in the system.

A simple example would be from our previous output dataframe, a model fit on `GenerationLabel` would think that value `6 > 5 > 4` and so on. While order is important in the case of Pokémon generations (ordinal variable), there is no notion of magnitude here. `Generation 6` is not larger than `Generation 5` and `Generation 1` is not smaller than `Generation 6`. Hence models built using these features directly would be sub-optimal and incorrect models. There are several schemes and strategies where dummy features are created for each unique value or label out of all the distinct categories in any feature. In the subsequent sections, we will discuss some of these schemes including one hot encoding, dummy coding, effect coding, and feature hashing schemes.

## One Hot Encoding Scheme

Considering we have numeric representation of any categorical feature with  $m$  labels, the one hot encoding scheme, encodes or transforms the feature into  $m$  binary features, which can only contain a value of 1 or 0. Each observation in the categorical feature is thus converted into a vector of size  $m$  with only one of the values as 1 (indicating it as active). Let's take our Pokémon dataset and perform some one hot encoding transformations on some of its categorical features.

```
In [8]: poke_df[['Name', 'Generation', 'Legendary']].iloc[4:10]
Out[8]:
```

	Name	Generation	Legendary	
4	Octillery	Gen 2	False	
5	Helioptile	Gen 6	False	
6	Dialga	Gen 4	True	
7	DeoxysDefense	Forme	Gen 3	True
8	Rapidash	Gen 1	False	
9	Swanna	Gen 5	False	

Considering the dataframe depicted in the output, we have two categorical features, `Generation` and `Legendary`, depicting the Pokémon generations and their legendary status. First, we need to transform these text labels into numeric representations. The following code helps us achieve this.

```
In [9]: from sklearn.preprocessing import OneHotEncoder, LabelEncoder
...:
...: # transform and map pokemon generations
...: gen_le = LabelEncoder()
```

```

...: gen_labels = gen_le.fit_transform(poke_df['Generation'])
...: poke_df['Gen_Label'] = gen_labels
...:
...: # transform and map pokemon legendary status
...: leg_le = LabelEncoder()
...: leg_labels = leg_le.fit_transform(poke_df['Legendary'])
...: poke_df['Lgnd_Label'] = leg_labels
...:
...: poke_df_sub = poke_df[['Name', 'Generation', 'Gen_Label', 'Legendary', 'Lgnd_Label']]
...: poke_df_sub.iloc[4:10]
Out[9]:

```

	Name	Generation	Gen_Label	Legendary	Lgnd_Label
4	Octillery	Gen 2	1	False	0
5	Helioptile	Gen 6	5	False	0
6	Dialga	Gen 4	3	True	1
7	DeoxysDefense Forme	Gen 3	2	True	1
8	Rapidash	Gen 1	0	False	0
9	Swanna	Gen 5	4	False	0

The features `Gen_Label` and `Lgnd_Label` now depict the numeric representations of our categorical features. Let's now apply the one hot encoding scheme on these features using the following code.

```

In [10]: # encode generation labels using one-hot encoding scheme
...: gen_ohc = OneHotEncoder()
...: gen_feature_arr = gen_ohc.fit_transform(poke_df[['Gen_Label']]).toarray()
...: gen_feature_labels = list(gen_le.classes_)
...: gen_features = pd.DataFrame(gen_feature_arr, columns=gen_feature_labels)
...:
...: # encode legendary status labels using one-hot encoding scheme
...: leg_ohc = OneHotEncoder()
...: leg_feature_arr = leg_ohc.fit_transform(poke_df[['Lgnd_Label']]).toarray()
...: leg_feature_labels = ['Legendary_'+str(cls_label) for cls_label in leg_le.classes_]
...: leg_features = pd.DataFrame(leg_feature_arr, columns=leg_feature_labels)

```

Now, you should remember that you can always encode both the features together using the `fit_transform(...)` function by passing it a two-dimensional array of the two features. But we are depicting this encoding for each feature separately, to make things easier to understand. Besides this, we can also create separate dataframes and label them accordingly. Let's now concatenate these feature frames and see the final result.

```

In [11]: poke_df_ohc = pd.concat([poke_df_sub, gen_features, leg_features], axis=1)
...: columns = sum(['Name', 'Generation', 'Gen_Label'], gen_feature_labels,
...:               ['Legendary', 'Lgnd_Label'], leg_feature_labels, [])
...: poke_df_ohc[columns].iloc[4:10]

```

Out[11]:

	Name	Generation	Gen_Label	Gen_1	Gen_2	Gen_3	Gen_4	Gen_5	Gen_6	Legendary	Lgnd_Label	Legendary_False	Legendary_True
4	Octillery	Gen 2	1	0.0	1.0	0.0	0.0	0.0	0.0	False	0	1.0	0.0
5	Helioptile	Gen 6	5	0.0	0.0	0.0	0.0	0.0	1.0	False	0	1.0	0.0
6	Dialga	Gen 4	3	0.0	0.0	0.0	1.0	0.0	0.0	True	1	0.0	1.0
7	DeoxysDefense Forme	Gen 3	2	0.0	0.0	1.0	0.0	0.0	0.0	True	1	0.0	1.0
8	Rapidash	Gen 1	0	1.0	0.0	0.0	0.0	0.0	0.0	False	0	1.0	0.0
9	Swanna	Gen 5	4	0.0	0.0	0.0	0.0	1.0	0.0	False	0	1.0	0.0

**Figure 4-15.** Feature set depicting one hot encoded features for Pokémon generation and legendary status

From the result feature set depicted in Figure 4-15, we can clearly see the new one hot encoded features for Gen\_Label and Lgnd\_Label. Each of these one hot encoded features is binary in nature and if they contain the value 1, it means that feature is active for the corresponding observation. For example, row 6 indicates the Pokémon Dialga is a Gen 4 Pokémon having Gen\_Label 3 (mapping starts from 0) and the corresponding one hot encoded feature Gen\_4 has the value 1 and the remaining one hot encoded features are 0. Similarly, its Legendary status is True, corresponding Lgnd\_Label is 1 and the one hot encoded feature Legendary\_True is also 1, indicating it is active.

Suppose we used this data in training and building a model but now we have some new Pokémon data for which we need to engineer the same features before we want to run it by our trained model. We can use the transform(...) function for our LabelEncoder and OneHotEncoder objects, which we have previously constructed to engineer the features from the training data. The following code shows us two dummy data points pertaining to new Pokémon.

```
In [12]: new_poke_df = pd.DataFrame([[ 'PikaZoom', 'Gen 3', True],
...:                               [ 'CharMyToast', 'Gen 4', False]],
...:                               columns=[ 'Name', 'Generation', 'Legendary'])
...: new_poke_df
```

```
Out[12]:
   Name Generation  Legendary
0  PikaZoom     Gen 3      True
1 CharMyToast     Gen 4     False
```

We will follow the same process as before of first converting the text categories into numeric representations using our previously built LabelEncoder objects, as depicted in the following code.

```
In [13]: new_gen_labels = gen_le.transform(new_poke_df[ 'Generation'])
...: new_poke_df[ 'Gen_Label'] = new_gen_labels
...:
...: new_leg_labels = leg_le.transform(new_poke_df[ 'Legendary'])
...: new_poke_df[ 'Lgnd_Label'] = new_leg_labels
...:
...: new_poke_df[[ 'Name', 'Generation', 'Gen_Label', 'Legendary', 'Lgnd_Label']]
```

```
Out[13]:
   Name Generation  Gen_Label  Legendary  Lgnd_Label
0  PikaZoom     Gen 3         2         True          1
1 CharMyToast     Gen 4         3         False         0
```

We can now use our previously built LabelEncoder objects and perform one hot encoding on these new data observations using the following code. See Figure 4-16.



```
In [14]: new_gen_feature_arr = gen_ohc.transform(new_poke_df[['Gen_Label']]).toarray()
...: new_gen_features = pd.DataFrame(new_gen_feature_arr, columns=gen_feature_labels)
...:
...: new_leg_feature_arr = leg_ohc.transform(new_poke_df[['Lgnd_Label']]).toarray()
...: new_leg_features = pd.DataFrame(new_leg_feature_arr, columns=leg_feature_labels)
...:
...: new_poke_ohc = pd.concat([new_poke_df, new_gen_features, new_leg_features], axis=1)
...: columns = sum(['Name', 'Generation', 'Gen_Label'], gen_feature_labels,
...:               ['Legendary', 'Lgnd_Label'], leg_feature_labels), [])
...: new_poke_ohc[columns]
```

Out[14]:

	Name	Generation	Gen_Label	Gen_1	Gen_2	Gen_3	Gen_4	Gen_5	Gen_6	Legendary	Lgnd_Label	Legendary_False	Legendary_True
0	PikaZoom	Gen 3	2	0.0	0.0	1.0	0.0	0.0	0.0	True	1	0.0	1.0
1	CharMyToast	Gen 4	3	0.0	0.0	0.0	1.0	0.0	0.0	False	0	1.0	0.0

Figure 4-16. Feature set depicting one hot encoded features for new pokemon data points

Thus, you can see how we used the `fit_transform(...)` functions to engineer features on our dataset and then we were able to use the encoder objects to engineer features on new data using the `transform(...)` function based on the data what it observed previously, specifically the distinct categories and their corresponding labels and one hot encodings. You should always follow this workflow in the future for any type of feature engineering when you deal with training and test datasets when you build models. Pandas also provides a wonderful function called `to_dummies(...)`, which helps us easily perform one hot encoding. The following code depicts how to achieve this.

```
In [15]: gen_onehot_features = pd.get_dummies(poke_df['Generation'])
...: pd.concat([poke_df[['Name', 'Generation']], gen_onehot_features], axis=1).
iloc[4:10]
Out[15]:
```

	Name	Generation	Gen_1	Gen_2	Gen_3	Gen_4	Gen_5	Gen_6
4	Octillery	Gen 2	0	1	0	0	0	0
5	Helioptile	Gen 6	0	0	0	0	0	1
6	Dialga	Gen 4	0	0	0	1	0	0
7	DeoxysDefense Forme	Gen 3	0	0	1	0	0	0
8	Rapidash	Gen 1	1	0	0	0	0	0
9	Swanna	Gen 5	0	0	0	0	1	0

The output depicts the one hot encoding scheme for Pokémon generation values similar to what we depicted in our previous analyses.

## Dummy Coding Scheme

The dummy coding scheme is similar to the one hot encoding scheme, except in the case of dummy coding scheme, when applied on a categorical feature with  $m$  distinct labels, we get  $m-1$  binary features. Thus each value of the categorical variable gets converted into a vector of size  $m-1$ . The extra feature is completely disregarded and thus if the category values range from  $\{0, 1, \dots, m-1\}$  the 0th or the  $m-1$ th feature is usually represented by a vector of all zeros (0).

The following code depicts the dummy coding scheme on Pokémon Generation by dropping the first level binary encoded feature (Gen 1).

```
In [16]: gen_dummy_features = pd.get_dummies(poke_df['Generation'], drop_first=True)
...: pd.concat([poke_df[['Name', 'Generation']], gen_dummy_features], axis=1).iloc[4:10]
Out[16]:
```

	Name	Generation	Gen 2	Gen 3	Gen 4	Gen 5	Gen 6
4	Octillery	Gen 2	1	0	0	0	0
5	Helioptile	Gen 6	0	0	0	0	1
6	Dialga	Gen 4	0	0	1	0	0
7	DeoxysDefense	Forme	Gen 3	0	1	0	0
8	Rapidash	Gen 1	0	0	0	0	0
9	Swanna	Gen 5	0	0	0	1	0

If you want, you can also choose to drop the last level binary encoded feature (Gen 6) by using the following code.

```
In [17]: gen_onehot_features = pd.get_dummies(poke_df['Generation'])
...: gen_dummy_features = gen_onehot_features.iloc[:, :-1]
...: pd.concat([poke_df[['Name', 'Generation']], gen_dummy_features], axis=1).iloc[4:10]
Out[17]:
```

	Name	Generation	Gen 1	Gen 2	Gen 3	Gen 4	Gen 5
4	Octillery	Gen 2	0	1	0	0	0
5	Helioptile	Gen 6	0	0	0	0	0
6	Dialga	Gen 4	0	0	0	1	0
7	DeoxysDefense	Forme	Gen 3	0	0	1	0
8	Rapidash	Gen 1	1	0	0	0	0
9	Swanna	Gen 5	0	0	0	0	1

Thus from these outputs you can see that based on the encoded level binary feature which we drop, that particular categorical value is represented by a vector/encoded features, which all represent 0. For example in the previous result feature set, Pokémon Helioptile belongs to Gen 6 and is represented by all 0s in the encoded dummy features.

## Effect Coding Scheme

The effect coding scheme is very similar to the dummy coding scheme in most aspects. However, the encoded features or feature vector, for the category values that represent all 0s in the dummy coding scheme, is replaced by -1s in the effect coding scheme. The following code depicts the effect coding scheme on the Pokémon Generation feature.

```
In [18]: gen_onehot_features = pd.get_dummies(poke_df['Generation'])
...: gen_effect_features = gen_onehot_features.iloc[:, :-1]
...: gen_effect_features.loc[np.all(gen_effect_features == 0, axis=1)] = -1.
...: pd.concat([poke_df[['Name', 'Generation']], gen_effect_features], axis=1).iloc[4:10]
Out[18]:
```

	Name	Generation	Gen 1	Gen 2	Gen 3	Gen 4	Gen 5
4	Octillery	Gen 2	0.0	1.0	0.0	0.0	0.0
5	Helioptile	Gen 6	-1.0	-1.0	-1.0	-1.0	-1.0
6	Dialga	Gen 4	0.0	0.0	0.0	1.0	0.0

7	DeoxysDefense	Forme	Gen 3	0.0	0.0	1.0	0.0	0.0
8		Rapidash	Gen 1	1.0	0.0	0.0	0.0	0.0
9		Swanna	Gen 5	0.0	0.0	0.0	0.0	1.0

We can clearly see from the output feature set that all 0s have been replaced by -1 in case of values which were previously all 0 in the dummy coding scheme.

## Bin-Counting Scheme

The encoding schemes discovered so far work quite well on categorical data in general, but they start causing problems when the number of distinct categories in any feature becomes very large. Essential for any categorical feature of  $m$  distinct labels, you get  $m$  separate features. This can easily increase the size of the feature set causing problems like storage issues, model training problems with regard to time, space and memory. Besides this, we also have to deal with what is popularly known as the curse of dimensionality where basically with an enormous number of features and not enough representative samples, model performance starts getting affected. Hence we need to look toward other categorical data feature engineering schemes for features having a large number of possible categories (like IP addresses).

The bin-counting scheme is useful for dealing with categorical variables with many categories. In this scheme, instead of using the actual label values for encoding, we use probability based statistical information about the value and the actual target or response value which we aim to predict in our modeling efforts. A simple example would be based on past historical data for IP addresses and the ones which were used in DDOS attacks; we can build probability values for a DDOS attack being caused by any of the IP addresses. Using this information, we can encode an input feature which depicts that if the same IP address comes in the future, what is the probability value of a DDOS attack being caused. This scheme needs historical data as a pre-requisite and is an elaborate one. Depicting this with a complete example is out of scope of this chapter but there are several resources online that you can refer to.

## Feature Hashing Scheme

The feature hashing scheme is another useful feature engineering scheme for dealing with large scale categorical features. In this scheme, a hash function is typically used with the number of encoded features pre-set (as a vector of pre-defined length) such that the hashed values of the features are used as indices in this pre-defined vector and values are updated accordingly. Since a hash function maps a large number of values into a small finite set of values, multiple different values might create the same hash which is termed as collisions. Typically, a signed hash function is used so that the sign of the value obtained from the hash is used as the sign of the value which is stored in the final feature vector at the appropriate index. This should ensure lesser collisions and lesser accumulation of error due to collisions.

Hashing schemes work on strings, numbers and other structures like vectors. You can think of hashed outputs as a finite set of  $h$  bins such that when hash function is applied on the same values, they get assigned to the same bin out of the  $h$  bins based on the hash value. We can assign the value of  $h$ , which becomes the final size of the encoded feature vector for each categorical feature we encode using the feature hashing scheme. Thus even if we have over 1000 distinct categories in a feature and we set  $h = 10$ , the output feature set will still have only 10 features as compared to 1000 features if we used a one hot encoding scheme.

Let's look at the following code snippet, which shows us the number of distinct genres we have in our video game dataset.

```
In [19]: unique_genres = np.unique(vg_df[['Genre']])
...: print("Total game genres:", len(unique_genres))
...: print(unique_genres)
```

```
Total game genres: 12
['Action' 'Adventure' 'Fighting' 'Misc' 'Platform' 'Puzzle' 'Racing'
 'Role-Playing' 'Shooter' 'Simulation' 'Sports' 'Strategy']
```

We can clearly see from the output that there are 12 distinct genres and if we used a one-hot encoding scheme on the Genre feature, we would end up having 12 binary features. Instead, we will now use a feature hashing scheme by leveraging `scikit-learn`'s `FeatureHasher` class, which uses a signed 32-bit version of the Murmurhash3 hash function. The following code shows us how to use the feature hashing scheme where we will pre-set the feature vector size to be 6 (6 features instead of 12).

```
In [21]: from sklearn.feature_extraction import FeatureHasher
...:
...: fh = FeatureHasher(n_features=6, input_type='string')
...: hashed_features = fh.fit_transform(vg_df['Genre'])
...: hashed_features = hashed_features.toarray()
...: pd.concat([vg_df[['Name', 'Genre']], pd.DataFrame(hashed_features)], axis=1).
      iloc[1:7]
```

```
Out[21]:
```

	Name	Genre	0	1	2	3	4	5
1	Super Mario Bros.	Platform	0.0	2.0	2.0	-1.0	1.0	0.0
2	Mario Kart Wii	Racing	-1.0	0.0	0.0	0.0	0.0	-1.0
3	Wii Sports Resort	Sports	-2.0	2.0	0.0	-2.0	0.0	0.0
4	Pokemon Red/Pokemon Blue	Role-Playing	-1.0	1.0	2.0	0.0	1.0	-1.0
5	Tetris	Puzzle	0.0	1.0	1.0	-2.0	1.0	-1.0
6	New Super Mario Bros.	Platform	0.0	2.0	2.0	-1.0	1.0	0.0

Thus we can clearly see from the result feature set that the Genre categorical feature has been encoded using the hashing scheme into 6 features instead of 12. We can also see that rows 1 and 6 denote the same genre of games, Platform which have been rightly encoded into the same feature vector as expected.

## Feature Engineering on Text Data

Dealing with structured data attributes like numeric or categorical variables are usually not as challenging as unstructured attributes like text and images. In case of unstructured data like text documents, the first challenge is dealing with the unpredictable nature of the syntax, format, and content of the documents, which make it a challenge to extract useful information for building models. The second challenge is transforming these textual representations into numeric representations that can be understood by Machine Learning algorithms. There exist various feature engineering techniques employed by data scientists daily to extract numeric feature vectors from unstructured text. In this section, we discuss several of these techniques. Before we get started, you should remember that there are two aspects to execute feature engineering on text data.

- Pre-processing and normalizing text
- Feature extraction and engineering

Without text pre-processing and normalization, the feature engineering techniques will not work at their core efficiency hence it is of paramount importance to pre-process textual documents. You can load `feature_engineering_text.py` directly and start running the examples or use the jupyter notebook, `Feature Engineering on Text Data.ipynb`, for a more interactive experience. Let's load the following necessary dependencies before we start.

```
In [1]: import pandas as pd
...: import numpy as np
...: import re
...: import nltk
```

Let's now load some sample text documents, do some basic pre-processing, and learn about various feature engineering strategies to deal with text data. The following code creates our sample text corpus (a collection of text documents), which we will use in this section.

```
In [2]: corpus = ['The sky is blue and beautiful.',
...:              'Love this blue and beautiful sky!',
...:              'The quick brown fox jumps over the lazy dog.',
...:              'The brown fox is quick and the blue dog is lazy!',
...:              'The sky is very blue and the sky is very beautiful today',
...:              'The dog is lazy but the brown fox is quick!']
...: ]
...: labels = ['weather', 'weather', 'animals', 'animals', 'weather', 'animals']
...: corpus = np.array(corpus)
...: corpus_df = pd.DataFrame({'Document': corpus,
...:                          'Category': labels})
...: corpus_df = corpus_df[['Document', 'Category']]
...: corpus_df
```

```
Out[2]:
```

	Document	Category
0	The sky is blue and beautiful.	weather
1	Love this blue and beautiful sky!	weather
2	The quick brown fox jumps over the lazy dog.	animals
3	The brown fox is quick and the blue dog is lazy!	animals
4	The sky is very blue and the sky is very beaut...	weather
5	The dog is lazy but the brown fox is quick!	animals

We can see that we have a total of six documents, where three of them are relevant to weather and the other three talk about animals as depicted by the Category class label.

## Text Pre-Processing

Before feature engineering, we need to pre-process, clean, and normalize the text like we mentioned before. There are multiple pre-processing techniques, some of which are quite elaborate. We will not be going into a lot of details in this section but we will be covering a lot of them in further detail in a future chapter when we work on text classification and sentiment analysis. Following are some of the popular pre-processing techniques.

- Text tokenization and lower casing
- Removing special characters
- Contraction expansion
- Removing stopwords
- Correcting spellings
- Stemming
- Lemmatization

For more details on these topics, you can jump ahead to Chapter 7 of this book or refer to the section “Text Normalization,” Chapter 3, page 115 of *Text Analytics with Python* (Apress; Dipanjan Sarkar, 2016), which covers each of these techniques in detail. We will be normalizing our text here by lowercasing, removing special characters, tokenizing, and removing stopwords. The following code helps us achieve this.

```
In [3]: wpt = nltk.WordPunctTokenizer()
...: stop_words = nltk.corpus.stopwords.words('english')
...:
...: def normalize_document(doc):
...:     # lower case and remove special characters\whitespaces
...:     doc = re.sub(r'^a-zA-Z0-9\s', '', doc, re.I)
...:     doc = doc.lower()
...:     doc = doc.strip()
...:     # tokenize document
...:     tokens = wpt.tokenize(doc)
...:     # filter stopwords out of document
...:     filtered_tokens = [token for token in tokens if token not in stop_words]
...:     # re-create document from filtered tokens
...:     doc = ' '.join(filtered_tokens)
...:     return doc
...:
...: normalize_corpus = np.vectorize(normalize_document)
```

The `np.vectorize(...)` function helps us run the same function over all elements of a numpy array instead of writing a loop. We will now use this function to pre-process our text corpus.

```
In [4]: norm_corpus = normalize_corpus(corpus)
...: norm_corpus
Out[4]:
array(['sky blue beautiful', 'love blue beautiful sky',
      'quick brown fox jumps lazy dog', 'brown fox quick blue dog lazy',
      'sky blue sky beautiful today', 'dog lazy brown fox quick'],
      dtype='<U32')
```

You can compare each text document with its original form in our initial dataframe. You will see that each document is in the lowercase, special symbols have been removed and stopwords (words which carry little meaning like articles, pronouns, etc.) have been removed. We can now engineer features from this pre-processed corpus.

## Bag of Words Model

This is perhaps one of the simplest yet effective schemes of vectorizing features from unstructured text. The core principle of this model is to convert text documents into numeric vectors. The dimension or size of each vector is  $N$  where  $N$  indicates all possible distinct words across the corpus of documents. Each document once transformed is a numeric vector of size  $N$  where the values or weights in the vector indicate the frequency of each word in that specific document. The following code helps us vectorize the text corpus into numeric feature vectors.

```
In [5]: from sklearn.feature_extraction.text import CountVectorizer
...:
...: cv = CountVectorizer(min_df=0., max_df=1.)
```

```

...: cv_matrix = cv.fit_transform(norm_corpus)
...: cv_matrix = cv_matrix.toarray()
...: cv_matrix
Out[5]:
array([[1, 1, 0, 0, 0, 0, 0, 0, 0, 1, 0],
       [1, 1, 0, 0, 0, 0, 0, 1, 0, 1, 0],
       [0, 0, 1, 1, 1, 1, 1, 0, 1, 0, 0],
       [0, 1, 1, 1, 1, 0, 1, 0, 1, 0, 0],
       [1, 1, 0, 0, 0, 0, 0, 0, 0, 2, 1],
       [0, 0, 1, 1, 1, 0, 1, 0, 1, 0, 0]], dtype=int64)

```

The output represents a numeric term frequency based feature vector for each document like we mentioned before. To understand it better, we can represent it using the feature names and view it as a dataframe.

```

In [6]: vocab = cv.get_feature_names()
...: pd.DataFrame(cv_matrix, columns=vocab)
Out[6]:
   beautiful  blue  brown  dog  fox  jumps  lazy  love  quick  sky  today
0           1    1      0   0   0      0    0    0      0    1      0
1           1    1      0   0   0      0    0    1      0    1      0
2           0    0      1   1   1      1    1    0      1    0      0
3           0    1      1   1   1      0    1    0      1    0      0
4           1    1      0   0   0      0    0    0      0    2      1
5           0    0      1   1   1      0    1    0      1    0      0

```

We can clearly see now that each row of the dataframe depicts the term frequency vector for each text document. Hence the name bag of words because this model represents unstructured text into a bag of words without taking into account word positions, syntax, or semantics.

## Bag of N-Grams Model

We have used single word terms as features in the above mentioned bag of words model. But what if we also wanted to take into account phrases or collection of words which occur in a sequence? N-grams help us achieve that. An n-gram is basically a collection of word tokens from a text document such that these tokens are contiguous and occur in a sequence. Bi-grams indicate n-grams of order 2 (two words), Tri-grams indicate n-grams of order 3 (three words), and so on. We can easily extend the bag of words model to use a bag of n-grams model to give us n-gram based feature vectors. The following code computes bi-gram based features on our corpus.

```

In [7]: bv = CountVectorizer(ngram_range=(2,2))
...: bv_matrix = bv.fit_transform(norm_corpus)
...: bv_matrix = bv_matrix.toarray()
...: vocab = bv.get_feature_names()
...: pd.DataFrame(bv_matrix, columns=vocab)

```

Out[7]:

	beautiful sky	beautiful today	blue beautiful	blue dog	blue sky	brown fox	dog lazy	fox jumps	fox quick	jumps lazy	lazy brown	lazy dog	love blue	quick blue	quick brown	sky beautiful	sky blue
0	0	0	1	0	0	0	0	0	0	0	0	0	0	0	0	0	1
1	1	0	1	0	0	0	0	0	0	0	0	0	1	0	0	0	0
2	0	0	0	0	0	1	0	1	0	1	0	1	0	0	1	0	0
3	0	0	0	1	0	1	1	0	1	0	0	0	0	1	0	0	0
4	0	1	0	0	1	0	0	0	0	0	0	0	0	0	0	1	1
5	0	0	0	0	0	1	1	0	1	0	1	0	0	0	0	0	0

Figure 4-17. Bi-gram feature vectors for our corpus based on bag of n-grams model

Figure 4-17 clearly shows our bi-gram feature vectors where each feature is a bi-gram of two contiguous words and the values depict the frequency of that bi-gram in each document. You can use the `ngram_range` parameter to extend the n-gram range to get n-grams of higher orders. Typically n-grams until order three are sufficient for most tasks in Machine Learning and natural language processing.

## TF-IDF Model

There are some potential problems which might arise with the Bag of Words model when it is used on large corpora. Since the feature vectors are based on absolute term frequencies, there might be some terms which occur frequently across all documents and these will tend to overshadow other terms in the feature set. The TF-IDF model tries to combat this issue by using a scaling or normalizing factor in its computation. TF-IDF stands for Term Frequency-Inverse Document Frequency, which uses a combination of two metrics in its computation, namely: term frequency (`tf`) and inverse document frequency (`idf`). This technique was developed for ranking results for queries in search engines and now it is an indispensable model in the world of information retrieval and text analytics.

Mathematically, we can define TF-IDF as  $tfidf = tf \times idf$ , which can be expanded further to be represented as follows.

$$tfidf(w, D) = tf(w, D) \times idf(w, D) = tf(w, D) \times \log \left( \frac{C}{df(w)} \right)$$

Here,  $tfidf(w, D)$  is the TF-IDF score for word  $w$  in document  $D$ . The term  $tf(w, D)$  represents the term frequency of the word  $w$  in document  $D$ , which can be obtained from the Bag of Words model. The term  $idf(w, D)$  is the inverse document frequency for the term  $w$ , which can be computed as the log transform of the total number of documents in the corpus  $C$  divided by the document frequency of the word  $w$ , which is basically the frequency of documents in the corpus where the word  $w$  occurs. The following code depicts TF-IDF based feature engineering on our corpus.

```
In [8]: from sklearn.feature_extraction.text import TfidfVectorizer
...:
...: tv = TfidfVectorizer(min_df=0., max_df=1., use_idf=True)
...: tv_matrix = tv.fit_transform(norm_corpus)
...: tv_matrix = tv_matrix.toarray()
...:
...: vocab = tv.get_feature_names()
...: pd.DataFrame(np.round(tv_matrix, 2), columns=vocab)
```



Out[8]:

	beautiful	blue	brown	dog	fox	jumps	lazy	love	quick	sky	today
0	0.60	0.52	0.00	0.00	0.00	0.00	0.00	0.00	0.00	0.60	0.00
1	0.46	0.39	0.00	0.00	0.00	0.00	0.00	0.66	0.00	0.46	0.00
2	0.00	0.00	0.38	0.38	0.38	0.54	0.38	0.00	0.38	0.00	0.00
3	0.00	0.36	0.42	0.42	0.42	0.00	0.42	0.00	0.42	0.00	0.00
4	0.36	0.31	0.00	0.00	0.00	0.00	0.00	0.00	0.00	0.72	0.52
5	0.00	0.00	0.45	0.45	0.45	0.00	0.45	0.00	0.45	0.00	0.00

Thus, the preceding output depicts the TF-IDF based feature vectors for each of our text documents. Notice how this is a scaled and normalized version as compared to the raw Bag of Words model. Interested readers who might want to dive into further details of how the internals of this model work can refer to page 181 of *Text Analytics with Python* (Apress; Dipanjan Sarkar, 2016).

## Document Similarity

You can even build on top of the tf-idf based features we engineered in the previous section and use them to generate new features which can be useful in multiple applications. An example of this is computing document similarity. This is very useful in domains like search engines, document clustering, and information retrieval. Document similarity is the process of using a distance or similarity based metric that can be used to identify how similar a text document is with another document based on features extracted from the documents like bag of words or tf-idf. Pairwise document similarity in a corpus involves computing document similarity for each pair of documents in a corpus. Thus if you have  $C$  documents in a corpus, you would end up with a  $C \times C$  matrix such that each row and column represents the similarity score for a pair of documents, which represent the indices at the row and column, respectively.

There are several similarity and distance metrics that are used to compute document similarity. These include cosine distance/similarity, BM25 distance, Hellinger-Bhattacharya distance, jaccard distance, and so on. In our analysis, we will be using perhaps the most popular and widely used similarity metric, cosine similarity. Cosine similarity basically gives us a metric representing the cosine of the angle between the feature vector representations of two text documents. Figure 4-18 shows some typical feature vector alignments for text documents.

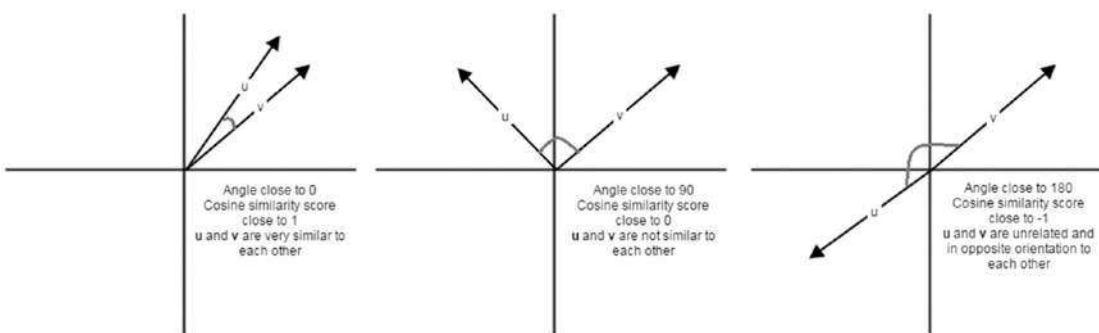

**Figure 4-18.** Cosine similarity depictions for text document feature vectors (Source: *Text Analytics with Python*, Apress)

From Figure 4-18, we can clearly see that feature vectors having a similar orientation will be very close to one another and the angle between them will be closer to  $0^\circ$  and thus cosine similarity would be  $\cos 0^\circ = 1$ . When cosine similarity is close to  $\cos 90^\circ = 0$ , the angle between the documents is closer to  $90^\circ$  indicating they are far apart and hence not very similar. Similarity scores close to  $-1$  indicate the documents have completely opposite orientation as the angle between them would be closer to  $180^\circ$ . The following code helps us compute pairwise cosine similarity for all the documents in our sample corpus.

```
In [9]: from sklearn.metrics.pairwise import cosine_similarity
...:
...: similarity_matrix = cosine_similarity(tv_matrix)
...: similarity_df = pd.DataFrame(similarity_matrix)
...: similarity_df
Out[9]:
```

	0	1	2	3	4	5
0	1.000000	0.753128	0.000000	0.185447	0.807539	0.000000
1	0.753128	1.000000	0.000000	0.139665	0.608181	0.000000
2	0.000000	0.000000	1.000000	0.784362	0.000000	0.839987
3	0.185447	0.139665	0.784362	1.000000	0.109653	0.933779
4	0.807539	0.608181	0.000000	0.109653	1.000000	0.000000
5	0.000000	0.000000	0.839987	0.933779	0.000000	1.000000

From the pairwise similarity matrix obtained in the preceding output, we can clearly see that documents 0, 1, and 4 have very strong similarity among one another. Also documents 2, 3, and 5 have strong similarity among themselves. This must indicate they all have some similar features. This is a perfect example of grouping or clustering that can be solved by unsupervised learning.

Let's use K-means clustering to try to use the features to see if we can actually cluster or group these documents based on their feature representations. In K-means clustering, we have an input parameter *k*, which specifies the number of clusters it will output using the document features. This clustering method is a centroid based clustering method, where it tries to cluster these documents into clusters of equal variance. It tries to create these clusters by minimizing the within-cluster sum of squares measure, also known as inertia. The following snippet builds a clustering model using our similarity features to cluster our text documents.

```
In [10]: from sklearn.cluster import KMeans
...:
...: km = KMeans(n_clusters=2)
...: km.fit_transform(similarity_df)
...: cluster_labels = km.labels_
...: cluster_labels = pd.DataFrame(cluster_labels, columns=['ClusterLabel'])
...: pd.concat([corpus_df, cluster_labels], axis=1)
Out[10]:
```

	Document	Category	ClusterLabel
0	The sky is blue and beautiful.	weather	0
1	Love this blue and beautiful sky!	weather	0
2	The quick brown fox jumps over the lazy dog.	animals	1
3	The brown fox is quick and the blue dog is lazy!	animals	1
4	The sky is very blue and the sky is very beaut...	weather	0
5	The dog is lazy but the brown fox is quick!	animals	1

The output obtained clearly shows us that our K-means clustering model has labeled our documents into two clusters with labels 0 and 1. We can also see that these labels are correct where labels with value 0 indicate documents relevant to weather and labels with value 1 indicate documents relevant to animals. Thus you can see how useful these features are in document clustering and categorization!

## Topic Models

Besides document terms, phrases and similarities, we can also use some summarization techniques to extract topic or concept based features from text documents. The idea of topic models revolves around the process of extracting key themes or concepts from a corpus of documents which are represented as topics. Each topic can be represented as a bag or collection of words/terms from the document corpus. Together, these terms signify a specific topic, theme or a concept and each topic can be easily distinguished from other topics by virtue of the semantic meaning conveyed by these terms. These concepts can range from simple facts and statements to opinions and outlook. Topic models are extremely useful in summarizing large corpus of text documents to extract and depict key concepts. They are also useful in extracting features from text data that capture latent patterns in the data.

There are various techniques for topic modeling and most of them involve some form of matrix decomposition. Some techniques like Latent Semantic Indexing (LSI) use matrix decomposition operations, more specifically Singular Valued Decomposition (refer back to important mathematical concepts in Chapter 1), to split a term-document matrix (transpose of our TF-IDF document-term feature matrix) into three matrices,  $U$ ,  $S$  &  $V^T$ . You can use the left singular vectors in matrix  $U$  and multiply it by the singular vectors  $S$  to get terms and their weights (signifying importance) per topic. You can use `scikit-learn` or `gensim` to use LSI based topic modeling.

Another technique is Latent Dirichlet Allocation (LDA), which uses a generative probabilistic model where each document consists of a combination of several topics and each term or word can be assigned to a specific topic. This is similar to pLSI based model (probabilistic LSI). Each latent topic contains a Dirichlet prior over them in the case of LDA. The math behind this is pretty involving and it would not be possible to go into details in the current scope. Interested readers can refer to page 241 of *Text Analytics with Python* (Apress; Dipanjan Sarkar, 2016) for further details on LDA. For the purpose of feature engineering, you need to remember that when LDA is applied on a document-term matrix (TF-IDF feature matrix), it gets decomposed into two main components. A document-topic matrix, which would be the feature matrix we are looking for and a topic-term matrix, which helps us in looking at potential topics in the corpus. The following code builds an LDA model to extract features and topics from our sample corpus.

```
In [11]: from sklearn.decomposition import LatentDirichletAllocation
...:
...: lda = LatentDirichletAllocation(n_topics=2, max_iter=100, random_state=42)
...: dt_matrix = lda.fit_transform(tv_matrix)
...: features = pd.DataFrame(dt_matrix, columns=['T1', 'T2'])
...: features
```

```
Out[11]:
```

	T1	T2
0	0.190615	0.809385
1	0.176860	0.823140
2	0.846148	0.153852
3	0.815229	0.184771
4	0.180563	0.819437
5	0.839140	0.160860

Thus, the `dt_matrix` refers to the document-topic matrix giving us two features since we chose number of topics to be 2. You can also use the other matrix obtained from the decomposition, the topic-term matrix to see the topics extracted from our corpus using the LDA model using the following code.

```
In [12]: tt_matrix = lda.components_
...: for topic_weights in tt_matrix:
...:     topic = [(token, weight) for token, weight in zip(vocab, topic_weights)]
...:     topic = sorted(topic, key=lambda x: -x[1])
```

```

...:     topic = [item for item in topic if item[1] > 0.6]
...:     print(topic)
...:     print()
[('fox', 1.7265536238698524), ('quick', 1.7264910761871224), ('dog', 1.7264019823624879),
('brown', 1.7263774760262807), ('lazy', 1.7263567668213813), ('jumps', 1.0326450363521607),
('blue', 0.7770158513472083)]

[('sky', 2.263185143458752), ('beautiful', 1.9057084998062579), ('blue',
1.7954559705805626), ('love', 1.1476805311187976), ('today', 1.0064979209198706)]

```

The preceding output represents each of the two topics as a collection of terms and their importance is depicted by the corresponding weight. It is definitely interesting to see that the two topics are quite distinguishable from each other by looking at the terms. The first topic shows terms relevant to animals and the second topic shows terms relevant to weather. This is reinforced by applying our unsupervised K-means clustering algorithm on our document-topic feature matrix (`dt_matrix`) using the following code snippet.

```

In [13]: km = KMeans(n_clusters=2)
...: km.fit_transform(features)
...: cluster_labels = km.labels_
...: cluster_labels = pd.DataFrame(cluster_labels, columns=['ClusterLabel'])
...: pd.concat([corpus_df, cluster_labels], axis=1)
Out[13]:

```

	Document	Category	ClusterLabel
0	The sky is blue and beautiful.	weather	0
1	Love this blue and beautiful sky!	weather	0
2	The quick brown fox jumps over the lazy dog.	animals	1
3	The brown fox is quick and the blue dog is lazy!	animals	1
4	The sky is very blue and the sky is very beaut...	weather	0
5	The dog is lazy but the brown fox is quick!	animals	1

This clearly makes sense and we can see that by just using two topic-model based features, we are still able to cluster our documents efficiently!

## Word Embeddings

There are several advanced word vectorization models that have recently gained a lot of prominence. Almost all of them deal with the concept of word embeddings. Basically, word embeddings can be used for feature extraction and language modeling. This representation tries to map each word or phrase into a complete numeric vector such that semantically similar words or terms tend to occur closer to each other and these can be quantified using these embeddings. The `word2vec` model is perhaps one of the most popular neural network based probabilistic language models and can be used to learn distributed representational vectors for words. Word embeddings produced by `word2vec` involve taking in a corpus of text documents, representing words in a large high dimensional vector space such that each word has a corresponding vector in that space and similar words (even semantically) are located close to one another, analogous to what we observed in document similarity earlier.

The `word2vec` model was released by Google in 2013 and uses a neural network based implementation with architectures like continuous Bag of Words and Skip-Grams to learn the distributed vector representations of words in a corpus. We will be using the `gensim` framework to implement the same model on our corpus to extract features. Some of the important parameters in the model are explained briefly as follows.

- **size:** Represents the feature vector size for each word in the corpus when transformed.
- **window:** Sets the context window size specifying the length of the window of words to be taken into account as belonging to a single, similar context when training.
- **min\_count:** Specifies the minimum word frequency value needed across the corpus to consider the word as a part of the final vocabulary during training the model.
- **sample:** Used to downsample the effects of words which occur very frequently.

The following snippet builds a `word2vec` embedding model on the documents of our sample corpus. Remember to tokenize each document before passing it to the model.

```
In [14]: from gensim.models import word2vec
...:
...: wpt = nltk.WordPunctTokenizer()
...: tokenized_corpus = [wpt.tokenize(document) for document in norm_corpus]
...:
...: # Set values for various parameters
...: feature_size = 10 # Word vector dimensionality
...: window_context = 10 # Context window size
...: min_word_count = 1 # Minimum word count
...: sample = 1e-3 # Downsample setting for frequent words
...:
...: w2v_model = word2vec.Word2Vec(tokenized_corpus, size=feature_size,
...:                               window=window_context, min_count = min_word_count,
...:                               sample=sample)
```

Using TensorFlow backend.

Each word in the corpus will essentially now be a vector itself of size 10. We can verify the same using the following code.

```
In [15]: w2v_model.wv['sky']
Out[15]:
array([ 0.02626196, -0.02171229, -0.04910386,  0.0194816 ,  0.01649994,
        0.01200452,  0.04641563,  0.01844106,  0.02693636, -0.02992732], dtype=float32)
```

A question might arise in your mind now that so far, we had feature vectors for each complete document, but now we have vectors for each word. How on earth do we represent entire documents now? We can do that using various aggregation and combinations. A simple scheme would be to use an averaged word vector representation, where we simply sum all the word vectors occurring in a document and then divide by the count of word vectors to represent an averaged word vector for the document. The following code enables us to do the same.

```
In [16]: def average_word_vectors(words, model, vocabulary, num_features):
...:
...:     feature_vector = np.zeros((num_features,), dtype="float64")
...:     nwords = 0.
...:
...:     for word in words:
...:         if word in vocabulary:
...:             nwords = nwords + 1.
```

```

...:         feature_vector = np.add(feature_vector, model[word])
...:
...:     if nwords:
...:         feature_vector = np.divide(feature_vector, nwords)
...:
...:     return feature_vector
...:
...:
...: def averaged_word_vectorizer(corpus, model, num_features):
...:     vocabulary = set(model.wv.index2word)
...:     features = [average_word_vectors(tokenized_sentence, model, vocabulary,
...:                                   num_features)
...:                for tokenized_sentence in corpus]
...:     return np.array(features)

```

In [17]: w2v\_feature\_array = averaged\_word\_vectorizer(corpus=tokenized\_corpus, model=w2v\_model,  
...: num\_features=feature\_size)  
...: pd.DataFrame(w2v\_feature\_array)

Out[17]:

	0	1	2	3	4	5	6	7	8	9
0	-0.010540	-0.015367	0.005373	-0.020741	0.030717	-0.022407	-0.001724	0.004722	0.026881	0.011909
1	-0.017797	-0.013693	-0.003599	-0.015436	0.022831	-0.017905	0.010470	0.001540	0.025658	0.016208
2	-0.020869	-0.018273	-0.019681	-0.004124	-0.010980	0.001654	-0.001310	0.003395	0.003760	0.010851
3	-0.017561	-0.017866	-0.016438	-0.007601	-0.005687	-0.008843	-0.002385	0.001444	0.005643	0.012638
4	0.002371	-0.006731	0.017480	-0.014220	0.022088	-0.014882	0.003067	0.002605	0.021167	0.006461
5	-0.018306	-0.012056	-0.015671	-0.011617	-0.011667	-0.005490	0.005404	-0.003512	-0.003198	0.013306

**Figure 4-19.** Averaged word vector feature set for our corpus documents

Thus, we have our averaged word vector based feature set for all our corpus documents, as depicted by the dataframe in Figure 4-19. Let's use a different clustering algorithm this time known as Affinity Propagation to try to cluster our documents based on these new features. Affinity Propagation is based on the concept of message passing and you do not need to specify the number of clusters beforehand like you did in K-means clustering.

```

In [18]: from sklearn.cluster import AffinityPropagation
...:
...: ap = AffinityPropagation()
...: ap.fit(w2v_feature_array)
...: cluster_labels = ap.labels_
...: cluster_labels = pd.DataFrame(cluster_labels, columns=['ClusterLabel'])
...: pd.concat([corpus_df, cluster_labels], axis=1)

```

Out[18]:

	Document	Category	ClusterLabel
0	The sky is blue and beautiful.	weather	0
1	Love this blue and beautiful sky!	weather	0
2	The quick brown fox jumps over the lazy dog.	animals	1

```

3 The brown fox is quick and the blue dog is lazy! animals 1
4 The sky is very blue and the sky is very beaut... weather 0
5 The dog is lazy but the brown fox is quick! animals 1

```

The preceding output uses the averaged word vectors based on word embeddings to cluster the documents in our corpus and we can clearly see that it has obtained the right clusters! There are several other schemes of aggregating word vectors like using TF-IDF weights along with the word vector representations. Besides this there have been recent advancements in the field of Deep Learning where architectures like RNNs and LSTMs are also used for engineering features from text data.

## Feature Engineering on Temporal Data

Temporal data involves datasets that change over a period of time and time-based attributes are of paramount importance in these datasets. Usually temporal attributes include some form of data, time, and timestamp values and often optionally include other metadata like time zones, daylight savings time information, and so on. Temporal data, especially time-series based data is extensively used in multiple domains like stock, commodity, and weather forecasting. You can load `feature_engineering_temporal.py` directly and start running the examples or use the jupyter notebook, `Feature Engineering on Temporal Data.ipynb`, for a more interactive experience. Let's load the following dependencies before we move on to acquiring some temporal data.

```

In [1]: import datetime
...: import numpy as np
...: import pandas as pd
...: from dateutil.parser import parse
...: import pytz

```

We will now use some sample time-based data as our source of temporal data by loading the following values in a dataframe.

```

In [2]: time_stamps = ['2015-03-08 10:30:00.360000+00:00', '2017-07-13 15:45:05.755000-07:00',
...:                  '2012-01-20 22:30:00.254000+05:30', '2016-12-25
00:30:00.000000+10:00']
...: df = pd.DataFrame(time_stamps, columns=['Time'])
...: df

```

```

Out[2]:
              Time
0  2015-03-08 10:30:00.360000+00:00
1  2017-07-13 15:45:05.755000-07:00
2  2012-01-20 22:30:00.254000+05:30
3  2016-12-25 00:30:00.000000+10:00

```

Of course by default, they are stored as strings or text in the dataframe so we can convert time into Timestamp objects by using the following code snippet.

```

In [3]: ts_objs = np.array([pd.Timestamp(item) for item in np.array(df.Time)])
...: df['TS_obj'] = ts_objs
...: ts_objs
Out[3]:
array([Timestamp('2015-03-08 10:30:00.360000+0000', tz='UTC'),

```

```
Timestamp('2017-07-13 15:45:05.755000-0700', tz='pytz.FixedOffset(-420)'),
Timestamp('2012-01-20 22:30:00.254000+0530', tz='pytz.FixedOffset(330)'),
Timestamp('2016-12-25 00:30:00+1000', tz='pytz.FixedOffset(600)']], dtype=object)
```

You can clearly see from the temporal values that we have multiple components for each `Timestamp` object which include date, time, and even a time based offset, which can be used to identify the time zone also. Of course there is no way we can directly ingest or use these features in any Machine Learning model. Hence we need specific strategies to extract meaningful features from this data. In the following sections, we cover some of these strategies that you can start using on your own temporal data in the future.

## Date-Based Features

Each temporal value has a date component that can be used to extract useful information and features pertaining to the date. These include features and components like year, month, day, quarter, day of the week, day name, day and week of the year, and many more. The following code depicts how we can obtain some of these features from our temporal data.

```
In [4]: df['Year'] = df['TS_obj'].apply(lambda d: d.year)
...: df['Month'] = df['TS_obj'].apply(lambda d: d.month)
...: df['Day'] = df['TS_obj'].apply(lambda d: d.day)
...: df['DayOfWeek'] = df['TS_obj'].apply(lambda d: d.dayofweek)
...: df['DayName'] = df['TS_obj'].apply(lambda d: d.weekday_name)
...: df['DayOfYear'] = df['TS_obj'].apply(lambda d: d.dayofyear)
...: df['WeekOfYear'] = df['TS_obj'].apply(lambda d: d.weekofyear)
...: df['Quarter'] = df['TS_obj'].apply(lambda d: d.quarter)
...:
...: df[['Time', 'Year', 'Month', 'Day', 'Quarter',
...:      'DayOfWeek', 'DayName', 'DayOfYear', 'WeekOfYear']]
```

Out[4]:

	Time	Year	Month	Day	Quarter	DayOfWeek	DayName	DayOfYear	WeekOfYear
0	2015-03-08 10:30:00.360000+00:00	2015	3	8	1	6	Sunday	67	10
1	2017-07-13 15:45:05.755000-07:00	2017	7	13	3	3	Thursday	194	28
2	2012-01-20 22:30:00.254000+05:30	2012	1	20	1	4	Friday	20	3
3	2016-12-25 00:30:00.000000+10:00	2016	12	25	4	6	Saturday	360	51

**Figure 4-20.** Date based features in temporal data

The features depicted in Figure 4-20 show some of the attributes we talked about earlier and have been derived purely from the date segment of each temporal value. Each of these features can be used as categorical features and further feature engineering can be done like one hot encoding, aggregations, binning, and more.



## Time-Based Features

Each temporal value also has a time component that can be used to extract useful information and features pertaining to the time. These include attributes like hour, minute, second, microsecond, UTC offset, and more. The following code snippet extracts some of the previously mentioned time-based features from our temporal data.

```
In [5]: df['Hour'] = df['TS_obj'].apply(lambda d: d.hour)
...: df['Minute'] = df['TS_obj'].apply(lambda d: d.minute)
...: df['Second'] = df['TS_obj'].apply(lambda d: d.second)
...: df['MUsecond'] = df['TS_obj'].apply(lambda d: d.microsecond)
...: df['UTC_offset'] = df['TS_obj'].apply(lambda d: d.utcoffset())
...:
...: df[['Time', 'Hour', 'Minute', 'Second', 'MUsecond', 'UTC_offset']]
```

Out[5]:

	Time	Hour	Minute	Second	MUsecond	UTC_offset
0	2015-03-08 10:30:00.360000+00:00	10	30	0	360000	00:00:00
1	2017-07-13 15:45:05.755000-07:00	15	45	5	755000	-1 days +17:00:00
2	2012-01-20 22:30:00.254000+05:30	22	30	0	254000	05:30:00
3	2016-12-25 00:30:00.000000+10:00	0	30	0	0	10:00:00

**Figure 4-21.** Time based features in temporal data

The features depicted in Figure 4-21 show some of the attributes we talked about earlier which have been derived purely from the time segment of each temporal value. We can further engineer these features based on categorical feature engineering techniques and even derive other features like extracting time zones. Let's try to use binning to bin each temporal value into a specific time of the day by leveraging the Hour feature we just obtained.

```
In [6]: hour_bins = [-1, 5, 11, 16, 21, 23]
...: bin_names = ['Late Night', 'Morning', 'Afternoon', 'Evening', 'Night']
...: df['TimeOfDayBin'] = pd.cut(df['Hour'],
...:                               bins=hour_bins, labels=bin_names)
...: df[['Time', 'Hour', 'TimeOfDayBin']]
```

Out[6]:

	Time	Hour	TimeOfDayBin
0	2015-03-08 10:30:00.360000+00:00	10	Morning
1	2017-07-13 15:45:05.755000-07:00	15	Afternoon
2	2012-01-20 22:30:00.254000+05:30	22	Night
3	2016-12-25 00:30:00.000000+10:00	0	Late Night

Thus you can see from the preceding output that based on hour ranges (0-5, 5-11, 11-16, 16-21, 21-23) we have assigned a specific time of the day bin for each temporal value. The UTC offset component of the temporal data is very useful in knowing how far ahead or behind is that time value from the UTC (Coordinated Universal Time), which is the primary time standard that clocks and time are regulated from. This information can also be used to engineer new features like potential time zones from which each temporal value might have been obtained. The following code helps us achieve the same.

```
In [7]: df['TZ_info'] = df['TS_obj'].apply(lambda d: d.tzinfo)
...: df['TimeZones'] = df['TS_obj'].apply(lambda d: list({d.astimezone(tz).tzname()
...:                                     for tz in map(pytz.timezone,
...:                                     pytz.all_timezones_set)
...:                                     if d.astimezone(tz).utcoffset() == d.utcoffset()}))
...:
...: df[['Time', 'UTC_offset', 'TZ_info', 'TimeZones']]
```

Out[7]:

	Time	UTC_offset	TZ_info	TimeZones
0	2015-03-08 10:30:00.360000+00:00	00:00:00	UTC	[WET, UTC, UCT, GMT]
1	2017-07-13 15:45:05.755000-07:00	-1 days +17:00:00	pytz.FixedOffset(-420)	[MST, GMT+7, PDT]
2	2012-01-20 22:30:00.254000+05:30	05:30:00	pytz.FixedOffset(330)	[IST]
3	2016-12-25 00:30:00.000000+10:00	10:00:00	pytz.FixedOffset(600)	[VLAT, ChST, AEST, PGT, DDUT, GMT-10, CHUT]

**Figure 4-22.** Time zone relevant features in temporal data

Thus as we mentioned earlier, the features depicted in Figure 4-22 show some of the attributes pertaining to time zone relevant information for each temporal value. We can also get time components in other formats, like the Epoch, which is basically the number of seconds that have elapsed since January 1, 1970 (midnight UTC) and the Gregorian Ordinal, where January 1st of year 1 is represented as 1 and so on. The following code helps us extract these representations. See Figure 4-23.

```
In [8]: df['TimeUTC'] = df['TS_obj'].apply(lambda d: d.tz_convert(pytz.utc))
...: df['Epoch'] = df['TimeUTC'].apply(lambda d: d.timestamp())
...: df['GregOrdinal'] = df['TimeUTC'].apply(lambda d: d.toordinal())
...:
...: df[['Time', 'TimeUTC', 'Epoch', 'GregOrdinal']]
```

Out[8]:

	Time	TimeUTC	Epoch	GregOrdinal
0	2015-03-08 10:30:00.360000+00:00	2015-03-08 10:30:00.360000+00:00	1.425811e+09	735665
1	2017-07-13 15:45:05.755000-07:00	2017-07-13 22:45:05.755000+00:00	1.499986e+09	736523
2	2012-01-20 22:30:00.254000+05:30	2012-01-20 17:00:00.254000+00:00	1.327079e+09	734522
3	2016-12-25 00:30:00.000000+10:00	2016-12-24 14:30:00+00:00	1.482590e+09	736322

**Figure 4-23.** Time components depicted in various representations

Do note we converted each temporal value to UTC before deriving the other features. These alternate representations of time can be further used for easy date arithmetic. The epoch gives us time elapsed in seconds and the Gregorian ordinal gives us time elapsed in days. We can use this to derive further features like time elapsed from the current time or time elapsed from major events of importance based on the problem we are trying to solve. Let's compute the time elapsed for each temporal value since the current time. See Figure 4-24.

```
In [9]: curr_ts = datetime.datetime.now(pytz.utc)
...: # compute days elapsed since today
...: df['DaysElapsedEpoch'] = (curr_ts.timestamp() - df['Epoch']) / (3600*24)
...: df['DaysElapsedOrdinal'] = (curr_ts.toordinal() - df['GregOrdinal'])
...:
...: df[['Time', 'TimeUTC', 'DaysElapsedEpoch', 'DaysElapsedOrdinal']]
```

Out[9]:

	Time	TimeUTC	DaysElapsedEpoch	DaysElapsedOrdinal
0	2015-03-08 10:30:00.360000+00:00	2015-03-08 10:30:00.360000+00:00	860.207396	860
1	2017-07-13 15:45:05.755000-07:00	2017-07-13 22:45:05.755000+00:00	1.696917	2
2	2012-01-20 22:30:00.254000+05:30	2012-01-20 17:00:00.254000+00:00	2002.936564	2003
3	2016-12-25 00:30:00.000000+10:00	2016-12-24 14:30:00+00:00	203.040734	203

**Figure 4-24.** Deriving elapsed time difference from current time

Based on our computations, each new derived feature should give us the elapsed time difference between the current time and the time value in the Time column (actually TimeUTC since conversion to UTC is necessary). Both the values are almost equal to one another, which is expected. Thus you can use time and date arithmetic to extract and engineer more features which can help build better models. Alternate time representations enable you to do date time arithmetic directly instead of dealing with specific API methods of Timestamp and datetime objects from Python. However you can use any method to get to the results you want. It's all about ease of use and efficiency!

## Feature Engineering on Image Data

Another very popular format of unstructured data is images. Sound and visual data in the form of images, video, and audio are very popular sources of data which pose a lot of challenge to data scientists in terms of processing, storage, feature extraction and modeling. However their benefits as sources of data are quite rewarding especially in the field of artificial intelligence and computer vision. Due to the unstructured nature of data, it is not possible to directly use images for training models. If you are given a raw image, you might have a hard time trying to think of ways to represent it so that any Machine Learning algorithm can utilize it for model training. There are various strategies and techniques that can be used in this case to engineer the right features from images. One of the core principles to remember when dealing with images is that any image can be represented as a matrix of numeric pixel values. With that thought in mind, let's get started! You can load `feature_engineering_image.py` directly and start running the examples or use the jupyter notebook, `Feature Engineering on Image Data.ipynb`, for a more interactive experience. Let's start by loading the necessary dependencies and configuration settings.

```
In [1]: import skimage
...: import numpy as np
...: import pandas as pd
...: import matplotlib.pyplot as plt
...: from skimage import io
...:
...: %matplotlib inline
```

The scikit-image (skimage) library is an excellent framework consisting of several useful interfaces and algorithms for image processing and feature extraction. Besides this, we will also leverage the mahotas framework, which is useful in computer vision and image processing. Open CV is another useful framework that you can check out if interested in aspects pertaining to computer vision. Let's now look at ways to represent images as useful feature vector representations.

## Image Metadata Features

There are tons of useful features obtainable from the image metadata itself without even processing the image. Most of this information can be found from the EXIF data, which is usually recorded for each image by the device when the picture is being taken. Following are some of the popular features that are obtainable from the image EXIF data.

- Image create date and time
- Image dimensions
- Image compression format
- Device make and model
- Image resolution and aspect ratio
- Image artist
- Flash, aperture, focal length, and exposure

For more details on what other data points can be used as features from image EXIF metadata, you can refer to <https://sno.phy.queensu.ca/~phil/exiftool/TagNames/EXIF.html>, which lists the possible EXIF tags.

## Raw Image and Channel Pixels

An image can be represented by the value of each of its pixels as a two dimensional array. We can leverage numpy arrays for this. However, color images usually have three components also known as channels. The R, G, and B channels stand for the red, green, and blue channels, respectively. This can be represented as a three dimensional array ( $m, n, c$ ) where  $m$  indicates the number of rows in the image,  $n$  indicates the number of columns. These are determined by the image dimensions. The  $c$  indicates which channel it represents (R, G or B). Let's load some sample color images now and try to understand their representation.

```
In [2]: cat = io.imread('datasets/cat.png')
...: dog = io.imread('datasets/dog.png')
...: df = pd.DataFrame(['Cat', 'Dog'], columns=['Image'])
...:
...: print(cat.shape, dog.shape)
(168, 300, 3) (168, 300, 3)
```

```
In [3]: fig = plt.figure(figsize = (8,4))
...: ax1 = fig.add_subplot(1,2, 1)
...: ax1.imshow(cat)
...: ax2 = fig.add_subplot(1,2, 2)
...: ax2.imshow(dog)
```

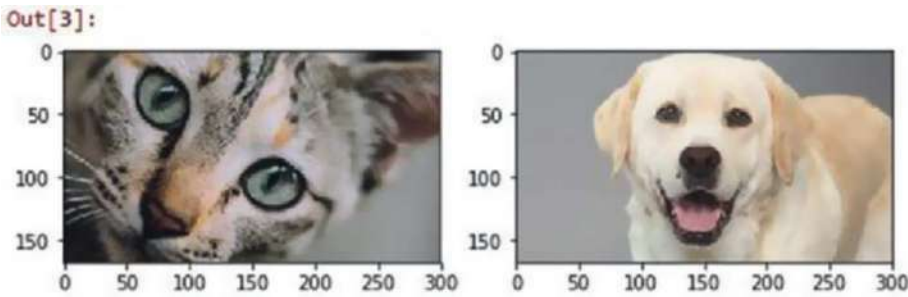

**Figure 4-25.** Our two sample color images

We can clearly see from Figure 4-25 that we have two images of a cat and a dog having dimensions 168x300 pixels where each row and column denotes a specific pixel of the image. The third dimension indicates these are color images having three color channels. Let's now try to use numpy indexing to slice out and extract the three color channels separately for the dog image.

```
In [4]: dog_r = dog.copy() # Red Channel
...: dog_r[:, :, 1] = dog_r[:, :, 2] = 0 # set G,B pixels = 0
...: dog_g = dog.copy() # Green Channel
...: dog_g[:, :, 0] = dog_r[:, :, 2] = 0 # set R,B pixels = 0
...: dog_b = dog.copy() # Blue Channel
...: dog_b[:, :, 0] = dog_b[:, :, 1] = 0 # set R,G pixels = 0
...:
...: plot_image = np.concatenate((dog_r, dog_g, dog_b), axis=1)
...: plt.figure(figsize = (10,4))
...: plt.imshow(plot_image)
```

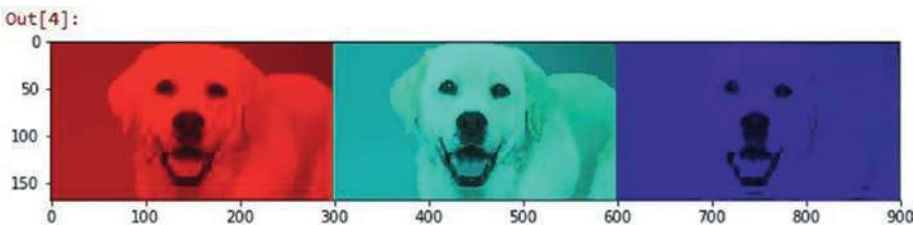

**Figure 4-26.** Extracting red, green, and blue channels from our color RGB image

We can clearly see from Figure 4-26 how we can easily use numpy indexing and extract out the three color channels from the sample image. You can now refer to any of these channel's raw image pixel matrix and even flatten it if needed to form a feature vector.

```
In [5]: dog_r[:, :, 0]
Out[5]:
array([[160, 160, 160, ..., 113, 113, 112],
       [160, 160, 160, ..., 113, 113, 112],
       ...,
       ...])
```

```
[165, 165, 165, ..., 212, 211, 210],
 [165, 165, 165, ..., 210, 210, 209],
 [164, 164, 164, ..., 209, 209, 209]], dtype=uint8)
```

This image pixel matrix is a two-dimensional matrix so you can extract features from this further or even flatten it to a one-dimensional vector to use as inputs for any Machine Learning algorithm.

## Grayscale Image Pixels

If you are dealing with color images, it might get difficult working with multiple channels and three-dimensional arrays. Hence converting images to grayscale is a nice way of keeping the necessary pixel intensity values but getting an easy to process two-dimensional image. Grayscale images usually capture the luminance or intensity of each pixel such that each pixel value can be computed using the equation

$$Y = 0.2125 \times R + 0.7154 \times G + 0.0721 \times B$$

Where  $R$ ,  $G$  &  $B$  are the pixel values of the three channels and  $Y$  captures the final pixel intensity information and is usually ranges from 0 (complete intensity absence - black) to 1 (complete intensity presence - white). The following snippet shows us how to convert RGB color images to grayscale and extract the raw pixel values, which can be used as features.

```
In [6]: from skimage.color import rgb2gray
...:
...: cgs = rgb2gray(cat)
...: dgs = rgb2gray(dog)
...:
...: print('Image shape:', cgs.shape, '\n')
...:
...: # 2D pixel map
...: print('2D image pixel map')
...: print(np.round(cgs, 2), '\n')
...:
...: # flattened pixel feature vector
...: print('Flattened pixel map:', (np.round(cgs.flatten(), 2)))
Image shape: (168, 300)
```

```
2D image pixel map
[[ 0.42  0.41  0.41 ...,  0.5  0.52  0.53]
 [ 0.41  0.41  0.4 ...,  0.51  0.52  0.54]
 ...,
 [ 0.11  0.11  0.1 ...,  0.51  0.51  0.51]
 [ 0.11  0.11  0.1 ...,  0.51  0.51  0.51]]
```

```
Flattened pixel map: [ 0.42  0.41  0.41 ...,  0.51  0.51  0.51]
```

## Binning Image Intensity Distribution

We already obtained the raw image intensity values for the grayscale images in the previous section. One approach would be to use these raw pixel values themselves as features. Another approach would be to binning the image intensity distribution based on intensity values using a histogram and using the bins as features. The following code snippet shows us how the image intensity distribution looks for the two sample images.

```
In [7]: fig = plt.figure(figsize = (8,4))
...: ax1 = fig.add_subplot(2,2, 1)
...: ax1.imshow(cgs, cmap="gray")
...: ax2 = fig.add_subplot(2,2, 2)
...: ax2.imshow(dgs, cmap='gray')
...: ax3 = fig.add_subplot(2,2, 3)
...: c_freq, c_bins, c_patches = ax3.hist(cgs.flatten(), bins=30)
...: ax4 = fig.add_subplot(2,2, 4)
...: d_freq, d_bins, d_patches = ax4.hist(dgs.flatten(), bins=30)
```

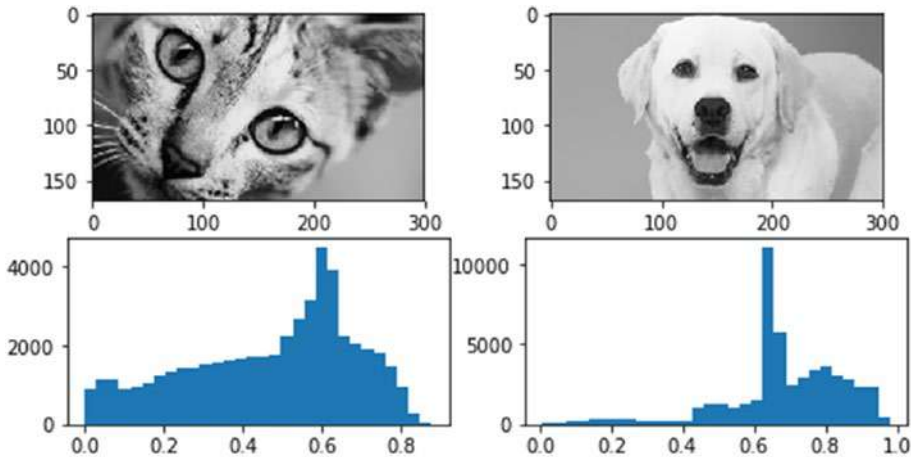

**Figure 4-27.** Binning image intensity distributions with histograms

As we mentioned, image intensity ranges from 0 to 1 and is evident by the x-axes depicted in Figure 4-27. The y-axes depict the frequency of the respective bins. We can clearly see that the dog image has more concentration of the bin frequencies around 0.6 - 0.8 indicating higher intensity and the reason for that being that the Labrador dog is white in color and white has a high intensity value like we mentioned in the previous section. The variables `c_freq`, `c_bins`, and `d_freq`, `d_bins` can be used to get the numeric values pertaining to the bins and used as features.

## Image Aggregation Statistics

We already obtained the raw image intensity values for the grayscale images in the previous section. One approach would be to use them as features directly or use some level of aggregations and statistical measures which can be obtained from the pixels and intensity. We already saw an approach of binning intensity values using histograms. In this section, we use descriptive statistical measures and aggregations to compute specific features from the image pixel values.

We can compute RGB ranges for each image by basically subtracting the maximum from the minimum value for pixel values in each channel. The following code helps us achieve this.

```
In [8]: from scipy.stats import describe
...:
...: cat_rgb = cat.reshape((168*300), 3).T
...: dog_rgb = dog.reshape((168*300), 3).T
```

```

...:
...: cs = describe(cat_rgb, axis=1)
...: ds = describe(dog_rgb, axis=1)
...:
...: cat_rgb_range = cs.minmax[1] - cs.minmax[0]
...: dog_rgb_range = ds.minmax[1] - ds.minmax[0]
...: rgb_range_df = pd.DataFrame([cat_rgb_range, dog_rgb_range],
...:                             columns=['R_range', 'G_range', 'B_range'])
...: pd.concat([df, rgb_range_df], axis=1)
Out[8]:
  Image  R_range  G_range  B_range
0  Cat      240     223     235
1  Dog      246     250     246

```

We can then use these range features as specific characteristic attributes of each image. Besides this, we can also compute other metrics like mean, median, variance, skewness, and kurtosis for each image channel as follows.

```

In [9]: cat_stats= np.array([np.round(cs.mean, 2),np.round(cs.variance, 2),
...:                         np.round(cs.kurtosis, 2),np.round(cs.skewness, 2),
...:                         np.round(np.median(cat_rgb, axis=1), 2)]).flatten()
...: dog_stats= np.array([np.round(ds.mean, 2),np.round(ds.variance, 2),
...:                      np.round(ds.kurtosis, 2),np.round(ds.skewness, 2),
...:                      np.round(np.median(dog_rgb, axis=1), 2)]).flatten()
...:
...: stats_df = pd.DataFrame([cat_stats, dog_stats],
...:                         columns=['R_mean', 'G_mean', 'B_mean', 'R_var', 'G_var',
...:                                 'B_var', 'R_kurt', 'G_kurt', 'B_kurt', 'R_skew',
...:                                 'G_skew', 'B_skew', 'R_med', 'G_med', 'B_med'])
...: pd.concat([df, stats_df], axis=1)

```

```

Out[9]:

```

Image	R_mean	G_mean	B_mean	R_var	G_var	B_var	R_kurt	G_kurt	B_kurt	R_skew	G_skew	B_skew	R_med	G_med	B_med
0 Cat	127.48	118.80	111.94	3054.04	2863.78	3003.05	-0.63	-0.77	-0.94	-0.48	-0.50	-0.25	140.0	132.0	120.0
1 Dog	184.46	173.46	160.77	1887.71	1776.00	1574.73	1.30	2.24	2.32	-0.96	-1.12	-1.09	185.0	169.0	165.0

**Figure 4-28.** Image channel aggregation statistical features

We can observe from the features obtained in Figure 4-28 that the mean, median, and kurtosis values for the various channels for the dog image are mostly greater than corresponding ones in the cat image. Variance and skewness are however more for the cat image.

## Edge Detection

One of the more interesting and sophisticated techniques involve detecting edges in an image. Edge detection algorithms can be used to detect sharp intensity and brightness changes in an image and find areas of interest. The canny edge detector algorithm developed by John Canny is one of the most widely used edge detector algorithms today. This algorithm typically involves using a Gaussian distribution with a specific standard deviation  $\sigma$  (sigma) to smoothen and denoise the image. Then we apply a Sobel filter to extract image intensity gradients. Norm value of this gradient is used to determine the edge strength.



Potential edges are thinned down to curves with width of 1 pixel and hysteresis based thresholding is used to label all points above a specific high threshold as edges and then recursively use the low threshold value to label points above the low threshold as edges connected to any of the previously labeled points. The following code applied the canny edge detector to our sample images.

```
In [10]: from skimage.feature import canny
...:
...: cat_edges = canny(cgs, sigma=3)
...: dog_edges = canny(dgs, sigma=3)
...:
...: fig = plt.figure(figsize = (8,4))
...: ax1 = fig.add_subplot(1,2, 1)
...: ax1.imshow(cat_edges, cmap='binary')
...: ax2 = fig.add_subplot(1,2, 2)
...: ax2.imshow(dog_edges, cmap='binary')
```

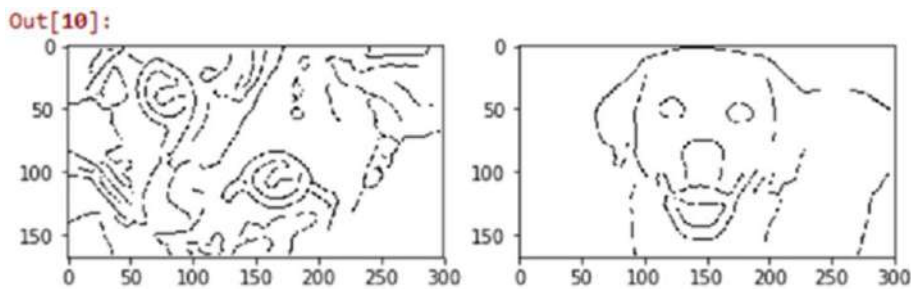

**Figure 4-29.** Canny edge detection to extract edge based features

The image plots based on the edge feature arrays depicted in Figure 4-29 clearly show the prominent edges of our cat and dog. You can use these edge feature arrays (`cat_edges` and `dog_edges`) by flattening them, extracting pixel values and positions pertaining to the edges (non-zero values), or even by aggregating them like finding out the total number of pixels making edges, mean value, and so on.

## Object Detection

Another interesting technique in the world of computer vision is object detection where features useful in highlighting specific objects in the image are detected and extracted. The histogram of oriented gradients, also known as HOG, is one of the techniques that's extensively used in object detection. Going into the details of this technique would not be possible in the current scope but for the process of feature engineering, you need to remember that the HOG algorithm works by following a sequence of steps similar to edge detection. The image is normalized and denoised to remove excess illumination effects. First order image gradients are computed to capture image attributes like contour, texture, and so on. Gradient histograms are built on top of these gradients based on specific windows called cells. Finally these cells are normalized and a flattened feature descriptor is obtained, which can be used as a feature vector for our models. The following code shows the HOG object detection technique on our sample images.

```
In [11]: from skimage.feature import hog
...: from skimage import exposure
...:
```

```

...: fd_cat, cat_hog = hog(cgs, orientations=8, pixels_per_cell=(8, 8),
...:                       cells_per_block=(3, 3), visualise=True)
...: fd_dog, dog_hog = hog(dgs, orientations=8, pixels_per_cell=(8, 8),
...:                       cells_per_block=(3, 3), visualise=True)
...:
...: # rescaling intensity to get better plots
...: cat_hogs = exposure.rescale_intensity(cat_hog, in_range=(0, 0.04))
...: dog_hogs = exposure.rescale_intensity(dog_hog, in_range=(0, 0.04))
...:
...: fig = plt.figure(figsize = (10,4))
...: ax1 = fig.add_subplot(1,2, 1)
...: ax1.imshow(cat_hogs, cmap='binary')
...: ax2 = fig.add_subplot(1,2, 2)
...: ax2.imshow(dog_hogs, cmap='binary')

```

Out[11]:

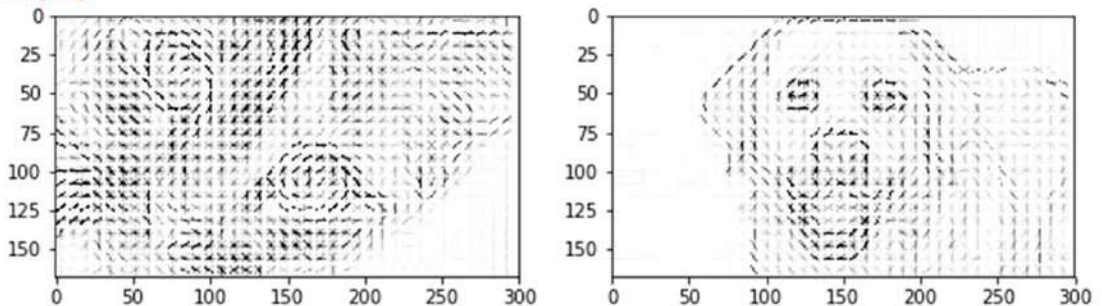

**Figure 4-30.** HOG object detector to extract features based on object detection

The image plots in Figure 4-30 show us how the HOG detector has identified the objects in our sample images. You can also get the flattened feature descriptors as follows.

```

In [12]: print(fd_cat, fd_cat.shape)
[ 0.00288784  0.00301086  0.0255757 ... ,  0.         0.         0.         ] (47880,)

```

## Localized Feature Extraction

We have talked about aggregating pixel values from two-dimensional image or feature matrices and also flattening them into feature vectors. Localized feature extraction based techniques are slightly better methods which try to detect and extract localized feature descriptors on various small localized regions of our input images. This is hence rightly named localized feature extraction. We will be using the popular and patented SURF algorithm invented by [Herbert Bay](#), et al. SURF stands for Speeded Up Robust Features. The main idea is to get scale invariant local feature descriptors from images which can be used later as image features. This algorithm is similar to the popular SIFT algorithm. There are mainly two major phases in this algorithm. The first phase is to detect points of interest using square shaped filters and hessian matrices. The second phase is to build feature descriptors by extracting localized features around these points of interest. There are usually computed by taking a localized square image region around a point of interest and then aggregating Haar wavelet responses at specific interval based sample points. We use the `mahotas` Python framework for extracting SURF feature descriptors from our sample images.

```
In [13]: from mahotas.features import surf
...: import mahotas as mh
...:
...: cat_mh = mh.colors.rgb2gray(cat)
...: dog_mh = mh.colors.rgb2gray(dog)
...:
...: cat_surf = surf.surf(cat_mh, nr_octaves=8, nr_scales=16, initial_step_size=1,
...:                       threshold=0.1, max_points=50)
...: dog_surf = surf.surf(dog_mh, nr_octaves=8, nr_scales=16, initial_step_size=1,
...:                       threshold=0.1, max_points=54)
...:
...: fig = plt.figure(figsize = (10,4))
...: ax1 = fig.add_subplot(1,2, 1)
...: ax1.imshow(surf.show_surf(cat_mh, cat_surf))
...: ax2 = fig.add_subplot(1,2, 2)
...: ax2.imshow(surf.show_surf(dog_mh, dog_surf))
```

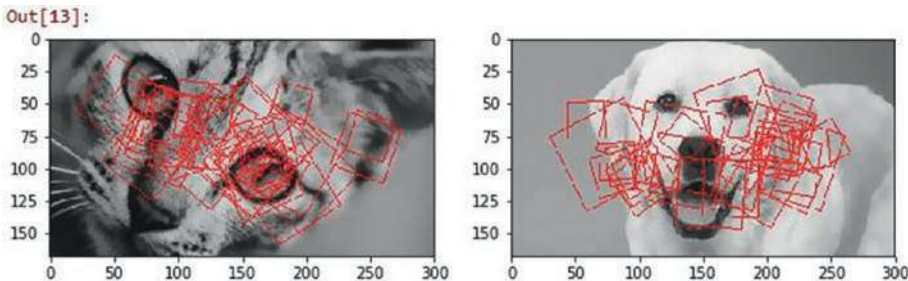

**Figure 4-31.** Localized feature extraction with SURF

The square boxes in the image plots in Figure 4-31 depict the square image regions around the points of interest which were used for localized feature extraction. You can also use the `surf.dense(...)` function to extract uniform dimensional feature descriptors at dense points with regular interval spacing in pixels. The following code depicts how to achieve this.

```
In [14]: cat_surf_fds = surf.dense(cat_mh, spacing=10)
...: dog_surf_fds = surf.dense(dog_mh, spacing=10)
...: cat_surf_fds.shape
Out[14]: (140, 64)
```

We see from the preceding output that we have obtained 140 feature descriptors of size 64 (elements) each. You can further apply other schemes on this like aggregation, flattening, and so on to derive further features. Another sophisticated technique that you can use to extract features on these SURF feature descriptors is to use the visual bag of words model, which we discuss in the next section.

## Visual Bag of Words Model

We have seen the effectiveness of the popular Bag of Words model in extracting meaningful features from unstructured text documents. Bag of words refers to the document being broken down into its constituents, words and computing frequency of occurrences or other measures like tf-idf. Similarly, in case of image raw pixel matrices or derived feature descriptors from other algorithms, we can apply a bag of words principle. However the constituents will not be words in this case but they will be subset of features/pixels extracted from images which are similar to each other.

Imagine you have multiple pictures of octopuses and you were able to extract the 140 dense surf features each having 64 values in each feature vector. You can now use an unsupervised learning algorithm like clustering to extract clusters of similar feature descriptors. Each cluster can be labeled as a *visual word* or a *visual feature*. Subsequently, each feature descriptor can be binned into one of these clusters or visual words. Thus, you end up getting a one-dimensional visual bag of words vector with counts of number of feature descriptors assigned to each of the visual words for the 140x64 feature descriptor matrix. Each feature or visual word tends to capture some portion of the images that are similar to each other like octopus eyes, tentacles, suckers, and so on, as depicted in Figure 4-32.

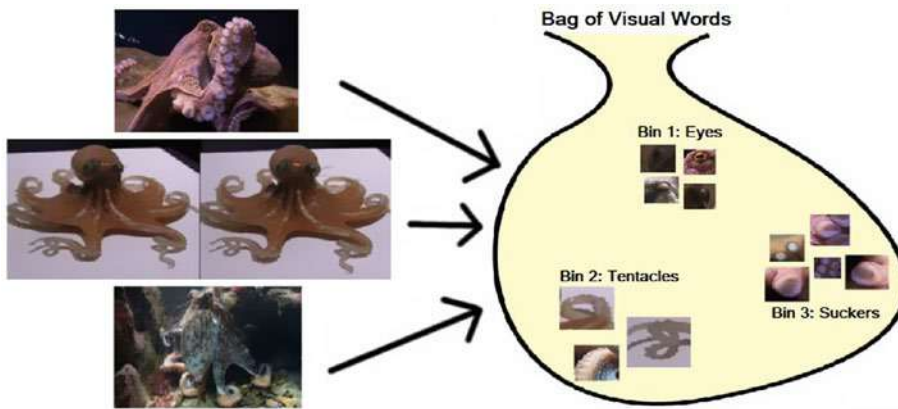

**Figure 4-32.** Visual bag of words (Courtesy of Ian London, *Image Classification in Python with Visual Bag of Words*)

The basic idea is hence to get a feature descriptor matrix from using any algorithm like SURF, apply an unsupervised algorithm like K-means clustering, and extract out  $k$  bins or visual features/words and their counts (based on number of feature descriptors assigned to each bin). Then for each subsequent image, once you extract the feature descriptors, you can use the K-means model to assign each feature descriptor to one of the visual feature clusters and get a one-dimensional vector of counts. This is depicted in Figure 4-33 for a sample octopus image, assuming our VBOw (Visual Bag of Words) model has three bins of eyes, tentacles, and suckers.



**Figure 4-33.** Transforming an image into a VBOW vector (Courtesy of Ian London, *Image Classification in Python with Visual Bag of Words*)

Thus you can see from Figure 4-33, how a two-dimensional image and its corresponding feature descriptors can be easily transformed into a one-dimensional VBOW vector [1, 3, 5]. Going into extensive details of the VBOW model would not be possible in the current scope, but I would like to thank my friend and fellow data scientist, Ian London, for helping me out with providing the two figures on VBOW models. I would also recommend you to check out his wonderful blog article <https://ianlondon.github.io/blog/visual-bag-of-words/>, which talks about using the VBOW model for image classification.

We will now use our 140x64 SURF feature descriptors for our two sample images and use K-means clustering on them and compute VBOW vectors for each image by assigning each feature descriptor to one of the bins. We will take k=20 in this case. See Figure 4-34.

```
In [15]: from sklearn.cluster import KMeans
...:
...: k = 20
...: km = KMeans(k, n_init=100, max_iter=100)
...:
...: surf_fd_features = np.array([cat_surf_fds, dog_surf_fds])
...: km.fit(np.concatenate(surf_fd_features))
...:
...: vbow_features = []
...: for feature_desc in surf_fd_features:
...:     labels = km.predict(feature_desc)
...:     vbow = np.bincount(labels, minlength=k)
...:     vbow_features.append(vbow)
...:
...: vbow_df = pd.DataFrame(vbow_features)
...: pd.concat([df, vbow_df], axis=1)
```

Out[15]:

Image	0	1	2	3	4	5	6	7	8	...	10	11	12	13	14	15	16	17	18	19
0 Cat	8	16	11	7	3	0	16	6	0	...	0	13	1	0	1	15	10	2	14	2
1 Dog	3	10	6	16	9	16	9	5	3	...	2	10	3	2	3	7	7	6	7	2

**Figure 4-34.** Transforming SURF descriptors into VBOW vectors for sample images

You can see how easy it is to transform complex two-dimensional SURF feature descriptor matrices into easy-to-interpret VBOV vectors. Let's now take a new image and think about how we could apply the VBOV pipeline. First we would need to extract the SURF feature descriptors from the image using the following snippet (This is only to depict the localized image subsets used in SURF we will actually use the dense features as before.) See Figure 4-35.

```
In [16]: new_cat = io.imread('datasets/new_cat.png')
...: newcat_mh = mh.colors.rgb2gray(new_cat)
...: newcat_surf = surf.surf(newcat_mh, nr_octaves=8, nr_scales=16, initial_step_size=1,
...:                        threshold=0.1, max_points=50)
...:
...: fig = plt.figure(figsize = (10,4))
...: ax1 = fig.add_subplot(1,2, 1)
...: ax1.imshow(surf.show_surf(newcat_mh, newcat_surf))
```

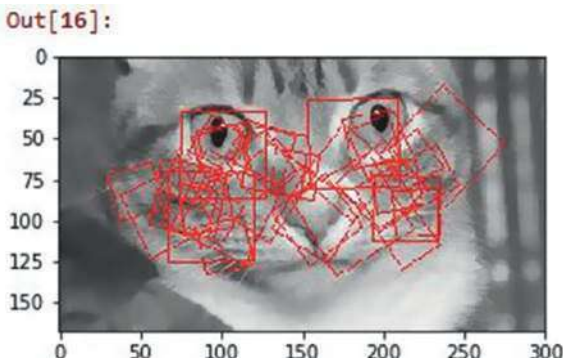

**Figure 4-35.** Localized feature extraction with SURF for new image

Let's now extract the dense SURF features and transform them into a VBOV vector using our previously trained VBOV model. The following code helps us achieve this. See Figure 4-36.

```
In [17]: new_surf_fds = surf.dense(newcat_mh, spacing=10)
...:
...: labels = km.predict(new_surf_fds)
...: new_vbow = np.bincount(labels, minlength=k)
...: pd.DataFrame([new_vbow])
```

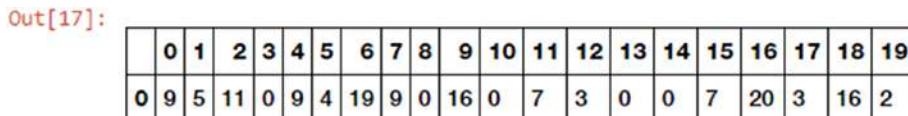

**Figure 4-36.** Transforming new image SURF descriptors into a VBOV vector

Thus you can see the final VBOV feature vector for the new image based on SURF feature descriptors. This is also an example of using an unsupervised Machine Learning model for feature engineering. You can now compare the similarity of this new image with the other two sample images using some similarity metrics.

```
In [18]: from sklearn.metrics.pairwise import euclidean_distances, cosine_similarity
...:
...: eucdis = euclidean_distances(new_vbow.reshape(1,-1) , vbow_features)
...: cossim = cosine_similarity(new_vbow.reshape(1,-1) , vbow_features)
...:
...: result_df = pd.DataFrame({'EuclideanDistance': eucdis[0],
...:                          'CosineSimilarity': cossim[0]})
...: pd.concat([df, result_df], axis=1)
Out[18]:
  Image  CosineSimilarity  EuclideanDistance
0  Cat          0.871609           21.260292
1  Dog          0.722096           30.000000
```

Based on the distance and similarity metrics, we can see that our new image (of a cat) is definitely closer to the cat image than the dog image. Try this out with a bigger dataset to get better results!

## Automated Feature Engineering with Deep Learning

We have used a lot of simple and sophisticated feature engineering techniques so far in this section. Building complex feature engineering systems and pipelines is time consuming and building algorithms for the same is even more tasking. Deep Learning is a novel and new approach toward automating this complex task of feature engineering by making the machine extract features automatically by learning multiple layered and complex representations of the underlying raw data.

Convolutional neural networks or CNNs are extensively used for automated feature extraction in images. We have already covered the basic principles of CNNs in Chapter 1. Go ahead and refresh your memory you heading to the “Important Concepts” sub-section under the “Deep Learning” section in Chapter 1. Just like we mentioned before, the idea of CNNs operate on the principles of convolution and pooling besides your regular activation function layers.

Convolutional layers typically slides or convolves learnable filters (also known as kernels or convolution matrix) across the entire width and height of the input image pixels. Dot products between the input pixels and the filter are computed at each position on sliding the filter. Two-dimensional activation maps for the filter get created and consequently the network is able to learn these filters when it activates on detecting specific features like edges, corners and so on. If we take  $n$  filters, we will get  $n$  separate two-dimensional activation maps, which can then be stacked along the depth dimension to get the output volume.

Pooling is a kind of aggregation or downsampling layer where typically a non-linear downsampling operation is inserted between convolutional layers. Filters are applied here too. They are slid along the convolution output matrix and, for each sliding operation, also known as a stride, elements in the slice of matrix covered by the pooling filter are either summed (Sum pooling) or averaged (Mean pooling) or the maximum value is selected (Max pooling). More than often max pooling works really well in several real-world scenarios. Pooling helps in reducing feature dimensionality and control model overfitting. Let’s now try to use Deep Learning for automated feature extraction on our sample images using CNNs. Load the following dependencies necessary for building deep networks.

```
In [19]: from keras.models import Sequential
...: from keras.layers.convolutional import Conv2D
...: from keras.layers.convolutional import MaxPooling2D
...: from keras import backend as K
Using TensorFlow backend.
```

You can use Theano or Tensorflow as your backend Deep Learning framework for keras to work on. I am using tensorflow in this scenario. Let's build a basic two-layer CNN now with a Max Pooling layer between them.

```
In [20]: model = Sequential()
...: model.add(Conv2D(4, (4, 4), input_shape=(168, 300, 3), activation='relu',
...:               kernel_initializer='glorot_uniform'))
...: model.add(MaxPooling2D(pool_size=(2, 2)))
...: model.add(Conv2D(4, (4, 4), activation='relu',
...:               kernel_initializer='glorot_uniform'))
```

We can actually visualize this network architecture using the following code snippet to understand the layers that have been used in this network, in a better way.

```
In [21]: from IPython.display import SVG
...: from keras.utils.vis_utils import model_to_dot
...:
...: SVG(model_to_dot(model, show_shapes=True,
...:                 show_layer_names=True, rankdir='TB').create(prog='dot', format='svg'))
```

Out[21]:

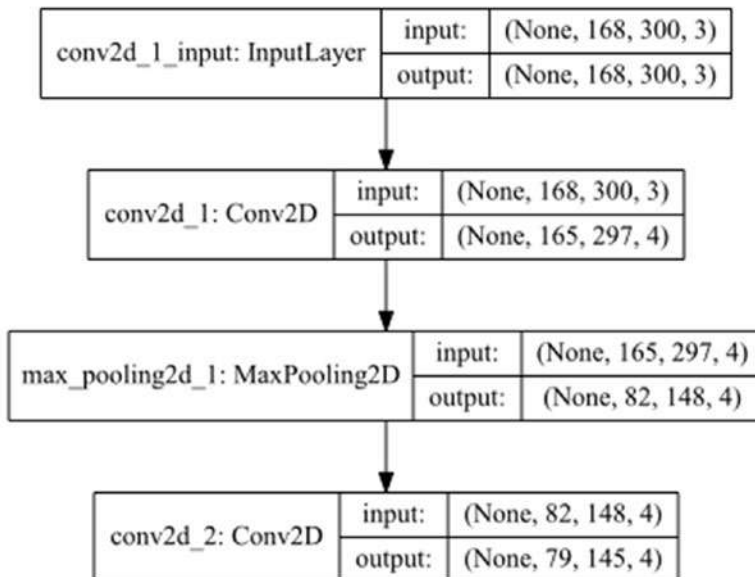

**Figure 4-37.** Visualizing our two-layer convolutional neural network architecture

You can now understand from the depiction in Figure 4-37 that we are using two two-dimensional Convolutional layers containing four (4x4) filters. We also have a Max Pool layer between them of size (2x2) for some downsampling. Let's now build some functions to extract features from these intermediate network layers.



```
In [22]: first_conv_layer = K.function([model.layers[0].input, K.learning_phase()],
...:                                  [model.layers[0].output])
...: second_conv_layer = K.function([model.layers[0].input, K.learning_phase()],
...:                                 [model.layers[2].output])
```

Let's now use these functions to extract the feature representations learned in the convolutional layers and visualize these features to see what the network is trying to learn from the images.

```
In [23]: catr = cat.reshape(1, 168, 300,3)
...:
...: # extract features
...: first_conv_features = first_conv_layer([catr])[0][0]
...: second_conv_features = second_conv_layer([catr])[0][0]
...:
...: # view feature representations
...: fig = plt.figure(figsize = (14,4))
...: ax1 = fig.add_subplot(2,4, 1)
...: ax1.imshow(first_conv_features[:, :,0])
...: ax2 = fig.add_subplot(2,4, 2)
...: ax2.imshow(first_conv_features[:, :,1])
...: ax3 = fig.add_subplot(2,4, 3)
...: ax3.imshow(first_conv_features[:, :,2])
...: ax4 = fig.add_subplot(2,4, 4)
...: ax4.imshow(first_conv_features[:, :,3])
...:
...: ax5 = fig.add_subplot(2,4, 5)
...: ax5.imshow(second_conv_features[:, :,0])
...: ax6 = fig.add_subplot(2,4, 6)
...: ax6.imshow(second_conv_features[:, :,1])
...: ax7 = fig.add_subplot(2,4, 7)
...: ax7.imshow(second_conv_features[:, :,2])
...: ax8 = fig.add_subplot(2,4, 8)
...: ax8.imshow(second_conv_features[:, :,3])
```

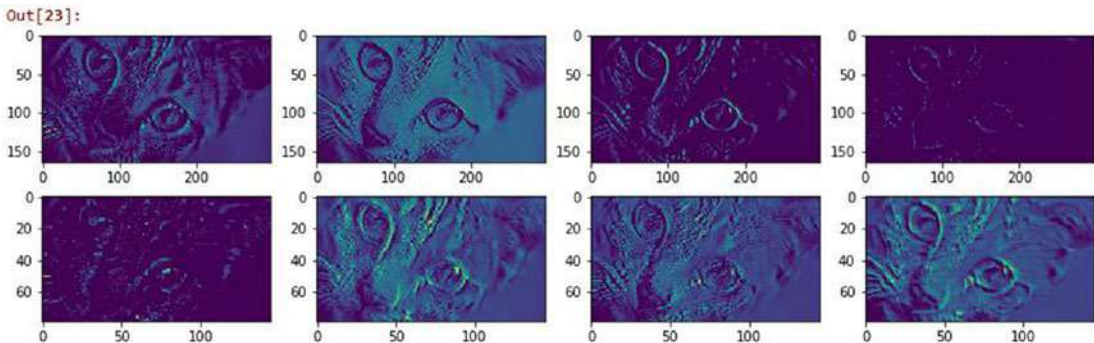

**Figure 4-38.** Intermediate feature maps obtained after passing through convolutional Layers

The feature map visualizations depicted in Figure 4-38 are definitely interesting. You can clearly see that each feature matrix produced by the convolutional neural network is trying to learn something about the image like its texture, corners, edges, illumination, hue, brightness, and so on. This should give you an idea of how these activation feature maps can then be used as features for images. In fact you can stack the output of a CNN, flatten it if needed, and pass it as an input layer to a multi-layer fully connected perceptron neural network and use it to solve the problem of image classification. This should give you a head start on automated feature extraction with the power of Deep Learning!

Don't worry if you did not understand some of the terms mentioned in this section; we will cover Deep Learning and CNNs in more depth in a subsequent chapter. If can't wait to get started with Deep Learning, you can fire up the bonus notebook provided with this chapter, called Bonus - Classifying handwritten digits using Deep CNNs.ipynb, for a complete real-world example of applying CNNs and Deep Learning to classify hand-written digits!

## Feature Scaling

When dealing with numeric features, we have specific attributes which may be completely unbounded in nature, like view counts of a video or web page hits. Using the raw values as input features might make models biased toward features having really high magnitude values. These models are typically sensitive to the magnitude or scale of features like linear or logistic regression. Other models like tree based methods can still work without feature scaling. However it is still recommended to normalize and scale down the features with feature scaling, especially if you want to try out multiple Machine Learning algorithms on input features. We have already seen some examples of scaling and transforming features using log and box-cox transforms earlier in this chapter. In this section, we look at some popular feature scaling techniques. You can load `feature_scaling.py` directly and start running the examples or use the jupyter notebook, `Feature Scaling.ipynb` for a more interactive experience. Let's start by loading the following dependencies and configurations.

```
In [1]: from sklearn.preprocessing import StandardScaler, MinMaxScaler, RobustScaler
...: import numpy as np
...: import pandas as pd
...: np.set_printoptions(suppress=True)
```

Let's now load some sample data of user views pertaining to online videos. The following snippet creates this sample dataset.

```
In [2]: views = pd.DataFrame([1295., 25., 19000., 5., 1., 300.], columns=['views'])
...: views
```

```
Out[2]:
   views
0  1295.0
1    25.0
2 19000.0
3     5.0
4     1.0
5   300.0
```

From the preceding dataframe we can see that we have five videos that have been viewed by users and the total view count for each video is depicted by the feature views. It is quite evident that some videos have been viewed a lot more than the others, giving a rise to values of high scale and magnitude. Let's look at how we can scale this feature using several handy techniques.

## Standardized Scaling

The standard scaler tries to standardize each value in a feature column by removing the mean and scaling the variance to be 1 from the values. This is also known as centering and scaling and can be denoted mathematically as

$$SS(X_i) = \frac{X_i - \mu_x}{\sigma_x}$$

where each value in feature  $X$  is subtracted by the mean  $\mu_x$  and the resultant is divided by the standard deviation  $\sigma_x$ . This is also popularly known as Z-score scaling. You can also divide the resultant by the variance instead of the standard deviation if needed. The following snippet helps us achieve this.

```
In [3]: ss = StandardScaler()
...: views['zscore'] = ss.fit_transform(views[['views']])
...: views
Out[3]:
   views  zscore
0  1295.0 -0.307214
1    25.0 -0.489306
2 19000.0  2.231317
3     5.0 -0.492173
4     1.0 -0.492747
5   300.0 -0.449877
```

We can see the standardized and scaled values in the `zscore` column in the preceding dataframe. In fact, you can manually use the formula we used earlier to compute the same result. The following example computes the z-score mathematically.

```
In [4]: vw = np.array(views['views'])
...: (vw[0] - np.mean(vw)) / np.std(vw)
Out[4]: -0.30721413311687235
```

## Min-Max Scaling

With min-max scaling, we can transform and scale our feature values such that each value is within the range of [0, 1]. However the `MinMaxScaler` class in `scikit-learn` also allows you to specify your own upper and lower bound in the scaled value range using the `feature_range` variable. Mathematically we can represent this scaler as

$$MMS(X_i) = \frac{X_i - \min(X)}{\max(X) - \min(X)}$$

where we scale each value in the feature  $X$  by subtracting it from the minimum value in the feature  $\min(X)$  and dividing the resultant by the difference between the maximum and minimum values in the feature  $\max(X) - \min(X)$ . The following snippet helps us compute this.

```
In [5]: mms = MinMaxScaler()
...: views['minmax'] = mms.fit_transform(views[['views']])
```

```

...: views
Out[5]:
   views  zscore  minmax
0  1295.0 -0.307214  0.068109
1    25.0 -0.489306  0.001263
2 19000.0  2.231317  1.000000
3     5.0 -0.492173  0.000211
4     1.0 -0.492747  0.000000
5    300.0 -0.449877  0.015738

```

The preceding output shows the min-max scaled values in the `minmax` column and as expected, the maximum viewed video in row index 2 has a value of 1, and the minimum viewed video in row index 4 has a value of 0. You can also compute this mathematically using the following code (sample computation for the first row).

```

In [6]: (vw[0] - np.min(vw)) / (np.max(vw) - np.min(vw))
Out[6]: 0.068108847834096528

```

## Robust Scaling

The disadvantage of min-max scaling is that often the presence of outliers affects the scaled values for any feature. Robust scaling tries to use specific statistical measures to scale features without being affected by outliers. Mathematically this scaler can be represented as

$$RS(X_i) = \frac{X_i - \text{median}(X)}{IQR_{(1,3)}(X)}$$

where we scale each value of feature  $X$  by subtracting the median of  $X$  and dividing the resultant by the IQR also known as the Inter-Quartile Range of  $X$  which is the range (difference) between the first quartile (25th %ile) and the third quartile (75th %ile). The following code performs robust scaling on our sample feature.

```

In [7]: rs = RobustScaler()
...: views['robust'] = rs.fit_transform(views[['views']])
...: views
Out[7]:
   views  zscore  minmax  robust
0  1295.0 -0.307214  0.068109  1.092883
1    25.0 -0.489306  0.001263 -0.132690
2 19000.0  2.231317  1.000000 18.178528
3     5.0 -0.492173  0.000211 -0.151990
4     1.0 -0.492747  0.000000 -0.155850
5    300.0 -0.449877  0.015738  0.132690

```

The scaled values are depicted in the `robust` column and you can compare them with the scaled features in the other columns. You can also compute the same using the mathematical equation we formulated for the robust scaler as depicted in the following snippet (for the first row index value).

```

In [8]: quartiles = np.percentile(vw, (25., 75.))

```

```

...: iqr = quartiles[1] - quartiles[0]
...: (vw[0] - np.median(vw)) / iqr
Out[8]: 1.0928829915560916

```

There are several other techniques for feature scaling and normalization, but these should be sufficient to get you started and are used extensively in building Machine Learning systems. Always remember to check if you need to scale and standardize features whenever you are dealing with numerical features.

## Feature Selection

While it is good to try to engineering features that try to capture some latent representations and patterns in the underlying data, it is not always a good thing to deal with feature sets having maybe thousands of features or even more. Dealing with a large number of features bring us to the concept of the curse of dimensionality which we mentioned earlier during the “Bin Counting” section in “Feature Engineering on Categorical Data.” More features tend to make models more complex and difficult to interpret. Besides this, it can often lead to models over-fitting on the training data. This basically leads to a very specialized model tuned only to the data which it used for training and hence even if you get a high model performance, it will end up performing very poorly on new, previously unseen data. The ultimate objective is to select an optimal number of features to train and build models that generalize very well on the data and prevent overfitting.

Feature selection strategies can be divided into three main areas based on the type of strategy and techniques employed for the same. They are described briefly as follows.

- **Filter methods:** These techniques select features purely based on metrics like correlation, mutual information and so on. These methods do not depend on results obtained from any model and usually check the relationship of each feature with the response variable to be predicted. Popular methods include threshold based methods and statistical tests.
- **Wrapper methods:** These techniques try to capture interaction between multiple features by using a recursive approach to build multiple models using feature subsets and select the best subset of features giving us the best performing model. Methods like backward selecting and forward elimination are popular wrapper based methods.
- **Embedded methods:** These techniques try to combine the benefits of the other two methods by leveraging Machine Learning models themselves to rank and score feature variables based on their importance. Tree based methods like decision trees and ensemble methods like random forests are popular examples of embedded methods.

The benefits of feature selection include better performing models, less overfitting, more generalized models, less time for computations and model training, and to get a good insight into understanding the importance of various features in your data. In this section, we look at some of the most widely used techniques in feature selection. You can load `feature_selection.py` directly and start running the examples or use the jupyter notebook, `Feature Selection.ipynb` for a more interactive experience. Let’s start by loading the following dependencies and configurations.

```

In [1]: import numpy as np
...: import pandas as pd
...: np.set_printoptions(suppress=True)
...: pt = np.get_printoptions()['threshold']

```

We will now look at various ways of selecting features including statistical and model based techniques by using some sample datasets.

## Threshold-Based Methods

This is a filter based feature selection strategy, where you can use some form of cut-off or thresholding for limiting the total number of features during feature selection. Thresholds can be of various forms. Some of them can be used during the feature engineering process itself, where you can specify threshold parameters. A simple example of this would be to limit feature terms in the Bag of Words model, which we used for text based feature engineering earlier. The `scikit-learn` framework provides parameters like `min_df` and `max_df` which can be used to specify thresholds for ignoring terms which have document frequency above and below user specified thresholds. The following snippet depicts a way to do this.

```
In [2]: from sklearn.feature_extraction.text import CountVectorizer
...:
...: cv = CountVectorizer(min_df=0.1, max_df=0.85, max_features=2000)
...: cv
Out[2]:
CountVectorizer(analyzer='word', binary=False, decode_error='strict',
                dtype=<class 'numpy.int64'>, encoding='utf-8', input='content',
                lowercase=True, max_df=0.85, max_features=2000, min_df=0.1,
                ngram_range=(1, 1), preprocessor=None, stop_words=None,
                strip_accents=None, token_pattern='(?u)\b\w+\b',
                tokenizer=None, vocabulary=None)
```

This basically builds a count vectorizer which ignores feature terms which occur in less than 10% of the total corpus and also ignores terms which occur in more than 85% of the total corpus. Besides this we also put a hard limit of 2000 maximum features in the feature set.

Another way of using thresholds is to use variance based thresholding where features having low variance (below a user-specified threshold) are removed. This signifies that we want to remove features that have values that are more or less constant across all the observations in our datasets. We can apply this to our Pokémon dataset, which we used earlier in this chapter. First we convert the `Generation` feature to a categorical feature as follows.

```
In [3]: df = pd.read_csv('datasets/Pokemon.csv')
...: poke_gen = pd.get_dummies(df['Generation'])
...: poke_gen.head()
```

```
Out[3]:
```

	Gen 1	Gen 2	Gen 3	Gen 4	Gen 5	Gen 6
0	1	0	0	0	0	0
1	1	0	0	0	0	0
2	1	0	0	0	0	0
3	1	0	0	0	0	0
4	1	0	0	0	0	0

Next, we want to remove features from the one hot encoded features where the variance is less than 0.15. We can do this using the following snippet.

```
In [4]: from sklearn.feature_selection import VarianceThreshold
...:
...: vt = VarianceThreshold(threshold=.15)
...: vt.fit(poke_gen)
Out[4]: VarianceThreshold(threshold=0.15)
```

To view the variances as well as which features were finally selected by this algorithm, we can use the `variances_` property and the `get_support(...)` function respectively. The following snippet depicts this clearly in a formatted dataframe.

```
In [5]: pd.DataFrame({'variance': vt.variances_,
...:                  'select_feature': vt.get_support()},
...:                  index=poke_gen.columns).T
Out[5]:
```

	Gen 1	Gen 2	Gen 3	Gen 4	Gen 5	Gen 6
select_feature	True	False	True	False	True	False
variance	0.164444	0.114944	0.16	0.128373	0.163711	0.0919937

We can clearly see which features have been selected based on their True values and also their variance being above 0.15. To get the final subset of selected features, you can use the following code.

```
In [6]: poke_gen_subset = poke_gen.iloc[:,vt.get_support()].head()
...: poke_gen_subset
Out[6]:
```

	Gen 1	Gen 3	Gen 5
0	1	0	0
1	1	0	0
2	1	0	0
3	1	0	0
4	1	0	0

The preceding feature subset depicts that features Gen 1, Gen 3, and Gen 5 have been finally selected out of the original six features.

## Statistical Methods

Another widely used filter based feature selection method, which is slightly more sophisticated, is to select features based on univariate statistical tests. You can use several statistical tests for regression and classification based models including mutual information, ANOVA (analysis of variance) and chi-square tests. Based on scores obtained from these statistical tests, you can select the best features on the basis of their score. Let's load a sample dataset now with 30 features. This dataset is known as the Wisconsin Diagnostic Breast Cancer dataset, which is also available in its native or raw format at [https://archive.ics.uci.edu/ml/datasets/Breast+Cancer+Wisconsin+\(Diagnostic\)](https://archive.ics.uci.edu/ml/datasets/Breast+Cancer+Wisconsin+(Diagnostic)), which is the UCI Machine Learning repository. We will use `scikit-learn` to load the data features and the response class variable.

```
In [7]: from sklearn.datasets import load_breast_cancer
...:
...: bc_data = load_breast_cancer()
...: bc_features = pd.DataFrame(bc_data.data, columns=bc_data.feature_names)
...: bc_classes = pd.DataFrame(bc_data.target, columns=['IsMalignant'])
...:
```

```

...: # build featureset and response class labels
...: bc_X = np.array(bc_features)
...: bc_y = np.array(bc_classes).T[0]
...: print('Feature set shape:', bc_X.shape)
...: print('Response class shape:', bc_y.shape)
Feature set shape: (569, 30)
Response class shape: (569,)

```

We can clearly see that, as we mentioned before, there are a total of 30 features in this dataset and a total of 569 rows of observations. To get some more detail into the feature names and take a peek at the data points, you can use the following code.

```

In [8]: np.set_printoptions(threshold=30)
...: print('Feature set data [shape: '+str(bc_X.shape)+']')
...: print(np.round(bc_X, 2), '\n')
...: print('Feature names:')
...: print(np.array(bc_features.columns), '\n')
...: print('Response Class label data [shape: '+str(bc_y.shape)+']')
...: print(bc_y, '\n')
...: print('Response variable name:', np.array(bc_classes.columns))
...: np.set_printoptions(threshold=pt)
Feature set data [shape: (569, 30)]
[[ 17.99  10.38 122.8 ... 0.27 0.46 0.12]
 [ 20.57  17.77 132.9 ... 0.19 0.28 0.09]
 [ 19.69  21.25 130. ... 0.24 0.36 0.09]
 ...,
 [ 16.6   28.08 108.3 ... 0.14 0.22 0.08]
 [ 20.6   29.33 140.1 ... 0.26 0.41 0.12]
 [ 7.76   24.54 47.92 ... 0.   0.29 0.07]]

Feature names:
['mean radius' 'mean texture' 'mean perimeter' 'mean area'
 'mean smoothness' 'mean compactness' 'mean concavity'
 'mean concave points' 'mean symmetry' 'mean fractal dimension'
 'radius error' 'texture error' 'perimeter error' 'area error'
 'smoothness error' 'compactness error' 'concavity error'
 'concave points error' 'symmetry error' 'fractal dimension error'
 'worst radius' 'worst texture' 'worst perimeter' 'worst area'
 'worst smoothness' 'worst compactness' 'worst concavity'
 'worst concave points' 'worst symmetry' 'worst fractal dimension']

Response Class label data [shape: (569,)]
[0 0 0 ..., 0 0 1]

Response variable name: ['IsMalignant']

```

This gives us a better perspective on the data we are dealing with. The response class variable is a binary class where 1 indicates the tumor detected was benign and 0 indicates it was malignant. We can also see the 30 features that are real valued numbers that describe characteristics of cell nuclei present in digitized images of breast mass. Let's now use the chi-square test on this feature set and select the top 15 best features out of the 30 features. The following snippet helps us achieve this.



```
In [9]: from sklearn.feature_selection import chi2, SelectKBest
...:
...: skb = SelectKBest(score_func=chi2, k=15)
...: skb.fit(bc_X, bc_y)
Out[9]: SelectKBest(k=15, score_func=<function chi2 at 0x0000018C2BEB7840>)
```

You can see that we have passed our input features (`bc_X`) and corresponding response class outputs (`bc_y`) to the `fit(...)` function when computing the necessary metrics. The chi-square test will compute statistics between each feature and the class variable (univariate tests). Selecting the top K features is more than likely to remove features having a low score and consequently they are most likely to be independent of the class variable and hence not useful in building models. We sort the scores to see the most relevant features using the following code.

```
In [10]: feature_scores = [(item, score) for item, score in zip(bc_data.feature_names,
                                                                skb.scores_)]
...: sorted(feature_scores, key=lambda x: -x[1])[:10]
Out[10]:
[('worst area', 112598.43156405364),
 ('mean area', 53991.655923750892),
 ('area error', 8758.5047053344697),
 ('worst perimeter', 3665.0354163405909),
 ('mean perimeter', 2011.1028637679051),
 ('worst radius', 491.68915743332195),
 ('mean radius', 266.10491719517802),
 ('perimeter error', 250.57189635982184),
 ('worst texture', 174.44939960571074),
 ('mean texture', 93.897508098633352)]
```

We can now create a subset of the 15 selected features obtained from our original feature set of 30 features with the help of the chi-square test by using the following code.

```
In [11]: select_features_kbest = skb.get_support()
...: feature_names_kbest = bc_data.feature_names[select_features_kbest]
...: feature_subset_df = bc_features[feature_names_kbest]
...: bc_SX = np.array(feature_subset_df)
...: print(bc_SX.shape)
...: print(feature_names_kbest)
(569, 15)
['mean radius' 'mean texture' 'mean perimeter' 'mean area' 'mean concavity'
 'radius error' 'perimeter error' 'area error' 'worst radius'
 'worst texture' 'worst perimeter' 'worst area' 'worst compactness'
 'worst concavity' 'worst concave points']
```

Thus from the preceding output, you can see that our new feature subset `bc_SX` has 569 observations of 15 features instead of 30 and we also printed the names of the selected features for your ease of understanding. To view the new feature set, you can use the following snippet.

```
In [12]: np.round(feature_subset_df.iloc[20:25], 2)
```

Out[12]:

mean radius	mean texture	mean perimeter	mean area	mean concavity	radius error	perimeter error	area error	worst radius	worst texture	worst perimeter	worst area	worst compactness	worst concavity	worst concave points
13.08	15.71	85.63	520.0	0.05	0.19	1.38	14.67	14.50	20.49	96.09	630.5	0.28	0.19	0.07
9.50	12.44	60.34	273.9	0.03	0.28	1.91	15.70	10.23	15.66	65.13	314.9	0.11	0.09	0.06
15.34	14.26	102.50	704.4	0.21	0.44	3.38	44.91	18.07	19.08	125.10	980.9	0.60	0.63	0.24
21.16	23.04	137.20	1404.0	0.11	0.69	4.30	93.99	29.17	35.59	188.00	2615.0	0.26	0.32	0.20
16.65	21.38	110.00	904.6	0.15	0.81	5.46	102.60	26.46	31.56	177.00	2215.0	0.36	0.47	0.21

**Figure 4-39.** Selected feature subset of the Wisconsin Diagnostic Breast Cancer dataset using chi-square tests

The dataframe with the top scoring features is depicted in Figure 4-39. Let's now build a simple classification model using logistic regression on the original feature set of 30 features and compare the model accuracy performance with another model built using our selected 15 features. For model evaluation, we will use the accuracy metric (percent of correct predictions) and use a five-fold cross-validation scheme. We will be covering model evaluation and tuning strategies in detail in Chapter 5, so do not despair if you cannot understand some of the terminology right now. The main idea here is to compare the model prediction performance between models trained on different feature sets.

```
In [13]: from sklearn.linear_model import LogisticRegression
...: from sklearn.model_selection import cross_val_score
...:
...: # build logistic regression model
...: lr = LogisticRegression()
...:
...: # evaluating accuracy for model built on full featureset
...: full_feat_acc = np.average(cross_val_score(lr, bc_X, bc_y, scoring='accuracy', cv=5))
...: # evaluating accuracy for model built on selected featureset
...: sel_feat_acc = np.average(cross_val_score(lr, bc_SX, bc_y, scoring='accuracy', cv=5))
...:
...: print('Model accuracy statistics with 5-fold cross validation')
...: print('Model accuracy with complete feature set', bc_X.shape, ':', full_feat_acc)
...: print('Model accuracy with selected feature set', bc_SX.shape, ':', sel_feat_acc)
Model accuracy statistics with 5-fold cross validation
Model accuracy with complete feature set (569, 30) : 0.950904193921
Model accuracy with selected feature set (569, 15) : 0.952643324356
```

The accuracy metrics clearly show us that we actually built a better model having accuracy of 95.26% when trained on the selected 15 feature subset as compared to the model built with the original 30 features which had an accuracy of 95.09%. Try this out on your own datasets! Do you see any improvements?

## Recursive Feature Elimination

You can also rank and score features with the help of a Machine Learning based model estimator such that you recursively keep eliminating lower scored features till you arrive at the specific feature subset count. Recursive Feature Elimination, also known as RFE, is a popular wrapper based feature selection technique, which allows you to use this strategy. The basic idea is to start off with a specific Machine Learning estimator like the Logistic Regression algorithm we used for our classification needs. Next we take the entire feature set of 30 features and the corresponding response class variables. RFE aims to assign weights to these features based on the model fit. Features with the smallest weights are pruned out and then a model is fit again on

the remaining features to obtain the new weights or scores. This process is recursively carried out multiple times and each time features with the lowest scores/weights are eliminated, until the pruned feature subset contains the desired number of features that the user wanted to select (this is taken as an input parameter at the start). This strategy is also popularly known as backward elimination. Let's select the top 15 features on our breast cancer dataset now using RFE.

```
In [14]: from sklearn.feature_selection import RFE
...:
...: lr = LogisticRegression()
...: rfe = RFE(estimator=lr, n_features_to_select=15, step=1)
...: rfe.fit(bc_X, bc_y)
Out[14]:
RFE(estimator=LogisticRegression(C=1.0, class_weight=None, dual=False, fit_intercept=True,
intercept_scaling=1, max_iter=100, multi_class='ovr', n_jobs=1,
penalty='l2', random_state=None, solver='liblinear', tol=0.0001,
verbose=0, warm_start=False),
n_features_to_select=15, step=1, verbose=0)
```

We can now use the `get_support(...)` function to obtain the final 15 selected features. This is depicted in the following snippet.

```
In [15]: select_features_rfe = rfe.get_support()
...: feature_names_rfe = bc_data.feature_names[select_features_rfe]
...: print(feature_names_rfe)
['mean radius' 'mean texture' 'mean perimeter' 'mean smoothness'
'mean concavity' 'mean concave points' 'mean symmetry' 'texture error'
'worst radius' 'worst texture' 'worst smoothness' 'worst concavity'
'worst concave points' 'worst symmetry' 'worst fractal dimension']
```

Can we compare this feature subset with the one we obtained using statistical tests in the previous section and see which features are common among both these subsets? Of course we can! Let's use set operations to get the list of features that were selected by both these techniques.

```
In [16]: set(feature_names_kbest) & set(feature_names_rfe)
Out[16]:
{'mean concavity', 'mean perimeter', 'mean radius', 'mean texture',
'worst concave points', 'worst concavity', 'worst radius', 'worst texture'}
```

Thus we can see that 8 out of 15 features are common and have been chosen by both the feature selection techniques, which is definitely interesting!

## Model-Based Selection

Tree based models like decision trees and ensemble models like random forests (ensemble of trees) can be utilized not just for modeling alone but for feature selection. These models can be used to compute feature importances when building the model that can in turn be used for selecting the best features and discarding irrelevant features with lower scores. Random forest is an ensemble model. This can be used as an embedded feature selection method, where each decision tree model in the ensemble is built by taking a training sample of data from the entire dataset. This sample is a bootstrap sample (sample taken with replacement). Splits at any node are taken by choosing the best split from a random subset of the features rather than taking all the features into account. This randomness tends to reduce the variance of the model

at the cost of slightly increasing the bias. Overall this produces a better and more generalized model. We will cover the bias-variance tradeoff in more detail in Chapter 5. Let's now use the random forest model to score and rank features based on their importance.

```
In [17]: from sklearn.ensemble import RandomForestClassifier
...:
...: rfc = RandomForestClassifier()
...: rfc.fit(bc_X, bc_y)
Out[17]:
RandomForestClassifier(bootstrap=True, class_weight=None, criterion='gini',
max_depth=None, max_features='auto', max_leaf_nodes=None,
min_impurity_split=1e-07, min_samples_leaf=1,
min_samples_split=2, min_weight_fraction_leaf=0.0,
n_estimators=10, n_jobs=1, oob_score=False, random_state=None,
verbose=0, warm_start=False)
```

The following code uses this random forest estimator to score the features based on their importance and we display the top 10 most important features based on this score.

```
In [18]: importance_scores = rfc.feature_importances_
...: feature_importances = [(feature, score) for feature, score in zip(bc_data.feature_
names, importance_scores)]
...: sorted(feature_importances, key=lambda x: -x[1])[10]
Out[18]:
[('worst area', 0.25116985146898885),
 ('worst radius', 0.16995187376059454),
 ('worst concavity', 0.1164662504282163),
 ('worst concave points', 0.11253251729478526),
 ('mean concave points', 0.10839170432994949),
 ('mean concavity', 0.063554137255925847),
 ('mean area', 0.023771318604377804),
 ('worst perimeter', 0.020636790800076958),
 ('worst texture', 0.019171556030722112),
 ('mean radius', 0.014908508522792335)]
```

You can now use a threshold based parameter to filter out the top  $n$  features as needed or you can even make use of the `SelectFromModel` meta-transformer provided by `scikit-learn` by using it as a wrapper on top of this model. Can you find out how many of the higher ranked features from the random forest model are in common with the previous two feature selectors?

## Dimensionality Reduction

Dealing with a lot of features can lead to issues like model overfitting, complex models, and many more that all roll up to what we have mentioned as the curse of dimensionality. Refer to the section “Dimensionality Reduction” in Chapter 1 to refresh your memory. Dimensionality reduction is the process of reducing the total number of features in our feature set using strategies like feature selection or feature extraction. We have already talked about feature selection extensively in the previous section. We now cover feature extraction where the basic objective is to extract new features from the existing set of features such that the higher-dimensional dataset with many features can be reduced into a lower-dimensional dataset of these newly created features. A very popular technique of linear data transformation from higher to lower dimensions is Principal Component Analysis, also known as PCA. Let's try to understand more about PCA and how we can use it for feature extraction in the following sections.

## Feature Extraction with Principal Component Analysis

Principal component analysis, popularly known as PCA, is a statistical method that uses the process of linear, orthogonal transformation to transform a higher-dimensional set of features that could be possibly correlated into a lower-dimensional set of linearly uncorrelated features. These transformed and newly created features are also known as Principal Components or PCs. In any PCA transformation, the total number of PCs is always less than or equal to the initial number of features. The first principal component tries to capture the maximum variance of the original set of features. Each of the succeeding components tries to capture more of the variance such that they are orthogonal to the preceding components. An important point to remember is that PCA is sensitive to feature scaling.

Our main task is to take a set of initial features with dimension let's say  $D$  and reduce it to a subset of extracted principal components of a lower dimension  $LD$ . The matrix decomposition process of Singular Value Decomposition is extremely useful in helping us obtain the principal components. You can quickly refresh your memory on SVD by referring to the sub-section of "Singular Value Decomposition" under the "Important Concepts" in the "Mathematics" section in Chapter 1 to check out the necessary mathematical formula and concepts. Considering we have a data matrix  $F_{(n \times D)}$ , where we have  $n$  observations and  $D$  dimensions (features), we can depict SVD of the feature matrix as  $(F_{(n \times D)}) = USV^T$  such that all the principal components are contained in the component  $V^T$ , which can be depicted as follows:

$$V^T_{(D \times D)} = \begin{bmatrix} PC_{1(1 \times D)} \\ PC_{2(1 \times D)} \\ \dots \\ PC_{D(1 \times D)} \end{bmatrix}$$

The principal components are represented by  $\{PC_1, PC_2, \dots, PC_D\}$ , which are all one-dimensional vectors of dimensions  $(1 \times D)$ . For extracting the first  $d$  principal components, we can first transpose this matrix to obtain the following representation.

$$PC_{(D \times D)} = (V^T)^T = \left[ PC_{1(D \times 1)} \mid PC_{2(D \times 1)} \mid \dots \mid PC_{D(D \times 1)} \right]$$

Now we can extract out the first  $d$  principal components such that  $d \leq D$  and the reduced principal component set can be depicted as follows.

$$PC_{(D \times D)} = (V^T)^T = \left[ PC_{1(D \times 1)} \mid PC_{2(D \times 1)} \mid \dots \mid PC_{D(D \times 1)} \right]$$

Finally, to perform dimensionality reduction, we can get the reduced feature set using the following mathematical transformation  $F_{(n \times d)} = F_{(n \times D)} \cdot PC_{(D \times d)}$  where the dot product between the original feature matrix and the reduced subset of principal components gives us a reduced feature set of  $d$  features. A very important point to remember here is that you might need to center your initial feature matrix by removing the mean because by default, PCA assumes that your data is centered around the origin.

Let's try to extract the first three principal components now from our breast cancer feature set of 30 features using SVD. We first center our feature matrix and then use SVD and subsetting to extract the first three PCs using the following code.

```
In [19]: # center the feature set
...: bc_XC = bc_X - bc_X.mean(axis=0)
...:
...: # decompose using SVD
...: U, S, VT = np.linalg.svd(bc_XC)
...:
...: # get principal components
...: PC = VT.T
...:
...: # get first 3 principal components
...: PC3 = PC[:, 0:3]
...: PC3.shape
Out[19]: (30, 3)
```

We can now get the reduced feature set of three features by using the dot product operation we discussed earlier. The following snippet gives us the final reduced feature set that can be used for modeling.

```
# reduce feature set dimensionality
np.round(bc_XC.dot(PC3), 2)
Out[20]:
array([[ -1160.14,  -293.92,  -48.58],
       [-1269.12,   15.63,   35.39],
       [-995.79,   39.16,    1.71],
       ...,
       [ -314.5 ,   47.55,   10.44],
       [-1124.86,   34.13,   19.74],
       [ 771.53,  -88.64,  -23.89]])
```

Thus you can see how powerful SVD and PCA can be in helping us reduce dimensionality by extracting necessary features. Of course in Machine Learning systems and pipelines you can use utilities from `scikit-learn` instead of writing unnecessary code and equations. The following code enables us to perform PCA on our breast cancer feature set leveraging `scikit-learn`'s APIs.

```
In [21]: from sklearn.decomposition import PCA
...: pca = PCA(n_components=3)
...: pca.fit(bc_X)
Out[21]:
PCA(copy=True, iterated_power='auto', n_components=3, random_state=None,
     svd_solver='auto', tol=0.0, whiten=False)
```

To understand how much of the variance is explained by each of these principal components, you can use the following code.

```
In [22]: pca.explained_variance_ratio_
Out[22]: array([ 0.98204467,  0.01617649,  0.00155751])
```

From the preceding output, as expected, we can see the maximum variance is explained by the first principal component. To obtain the reduced feature set, we can use the following snippet.

```
In [23]: bc_pca = pca.transform(bc_X)
...: np.round(bc_pca, 2)
Out[23]:
array([[ 1160.14, -293.92,  48.58],
       [ 1269.12,  15.63, -35.39],
       [  995.79,  39.16, -1.71],
       ...,
       [  314.5 ,  47.55, -10.44],
       [ 1124.86,  34.13, -19.74],
       [-771.53, -88.64,  23.89]])
```

If you compare the values of this reduced feature set with the values obtained in our mathematical implementation based code, you will see they are exactly the same except sign inversions in some cases.

---

The reason for sign inversion in some of the values in principal components is because the direction of these principal components is unstable. The sign indicates direction. Hence even if the principal components point in opposite directions, they should still be on the same plane and hence shouldn't have an effect when modeling with this data.

---

Let's now quickly build a logistic regression model as before and use model accuracy and five-fold cross validation to evaluate the model quality using these three features.

```
In [24]: np.average(cross_val_score(lr, bc_pca, bc_y, scoring='accuracy', cv=5))
Out[24]: 0.92808003078106949
```

We can see from the preceding output that even though we used only three features derived from the principal components instead of the original 30 features, we still obtained a model accuracy close to 93%, which is quite decent!

## Summary

This was a content packed chapter with a lot of hands-on examples based on real-world datasets. The main intent of this chapter is to get you familiarized with essential concepts, tools, techniques, and strategies used for feature extraction, engineering, scaling, and selection. One of the toughest tasks that data scientists face day in and day out is data processing and feature engineering. Hence it is of paramount importance that you understand the various aspects involved with deriving features from raw data. This chapter is intended to be used both as a starting ground as well as a reference guide for understanding what techniques and strategy should be applied when trying to engineer features on your own datasets. We cover the basic concepts of feature engineering, scaling, and selection and also the importance behind each of these processes. Feature engineering techniques are covered extensively for diverse data types including numerical, categorical, text,

temporal and images. Multiple feature scaling techniques are also covered, which are useful to tone down the scale and magnitude of features before modeling. Finally, we cover feature selection techniques in detail with emphasis on the three different strategies of feature selection namely filter, wrapper, and embedded methods. Special sections on dimensionality reduction and automated feature extraction using Deep Learning have also been included since they have gained a lot of prominence in both research as well as the industry. I want to conclude this chapter by leaving you with the following quote by Peter Norvig, renowned computer scientist and director at Google, which should reinforce the importance of feature engineering.

*“More data beats clever algorithms, but better data beats more data.”*

—Peter Norvig



## CHAPTER 5



# Building, Tuning, and Deploying Models

A very popular saying in the Machine Learning community is “70% of Machine Learning is data processing” and going by the structure of this book, the quote seems quite apt. In the preceding chapters, you saw how you can extract, process, and transform data to convert it to a form suitable for learning using Machine Learning algorithms. This chapter deals with the most important part of using that processed data, to learn a model that you can then use to solve real-world problems. You also learned about the CRISP-DM methodology for developing data solutions and projects—the step involving building and tuning these models is the final step in the iterative cycle of Machine Learning.

If you followed all the steps prescribed in the earlier chapters by now you must have a cleaned and processed data/feature set. This data will mostly be numeric in the form of arrays or dataframes (feature set). Most Machine Learning algorithms require the data to be in a numeric format as at the heart of any Machine Learning algorithm, we have some mathematical equations and an optimization problem to either minimize error/loss or maximize profit. Hence Machine Learning algorithms always work on numeric data. Check out Chapter 4 for feature engineering techniques to convert structured as well as unstructured data into ready-to-use numeric formats. We start this chapter by learning about different types of algorithms you can use. Then you will learn how to choose a relevant algorithm for the data that you have, you will then be introduced to the concept of hyperparameters and learn how to tune the hyperparameters of any algorithm. The chapter also covers a novel approach to interpreting models using open source frameworks. Besides this, you will also learn about persisting and deploying the developed models so you can start using them for your own needs and benefits.

Based on the preceding topics, the chapter includes into the following five major sections:

- Building models
- Model evaluation techniques
- Model tuning
- Model interpretation
- Deploying models in action

You should be fully acquainted with the material of the earlier chapters, since it will help in a better understanding of the various aspects of this chapter. All the code snippets and examples used in this chapter are available in the GitHub repository for this book at <https://github.com/dipanjanS/practical-machine-learning-with-python> under the directory/folder for Chapter 5. You can refer to the Python file named `model_build_tune_deploy.py` for all the examples used in this chapter and try the examples as you read this chapter or you can even refer to the jupyter notebook named `Building, Tuning and Deploying Models.ipynb` for a more interactive experience.

## Building Models

Before we get on with the process of building models, we should try to understand what a model represents. In the simplest of terms, a *model* can be described as a relationship between output or response variables and its corresponding input or independent variables in a dataset. Sometimes this relationship can just be among input variables (in case of datasets with no defined output or dependent variables). This relationship among variables can be expressed in terms of mathematical equations, functions, and rules, which link the output of the model to its inputs.

Consider the case of linear regression analysis, the output in that case is a set of parameters also known as weights or coefficients (we explore this later in the chapter) and those parameters define the relationship between the input and output variables. The idea is to build a model using a learning process, such that you can learn the necessary parameters (coefficients) in the model that help translate the input variables (independent) into the corresponding output variable (dependent) with the least error for a dataset (leveraging validation metrics like mean squared error). The idea is not to predict a correct output value for every input data point (leads to model over-fitting) but to generalize well over lots of data points such that the error is minimum and the same is maintained when you use this model over new data points. This is done by learning the right values of coefficients\parameters during the model building process. So when we say we are learning a linear regression model, these are the set of important considerations implicit in that statement. See Figure 5-1.

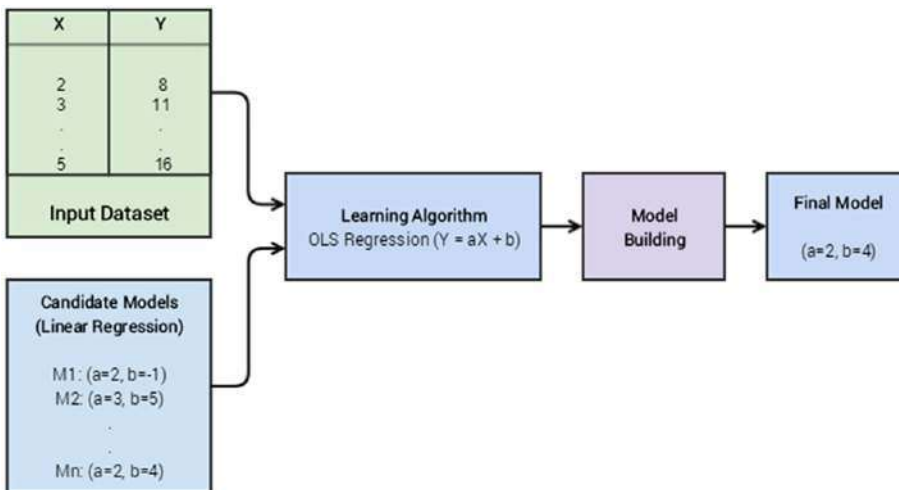

**Figure 5-1.** A high-level representation of model building

When we specify linear regression as the *candidate model*, we define the nature of relationship between our dependent and independent variables. The candidate model then becomes all the possible combinations of *parameters* for our model (more on this later). The learning algorithm is the way to determine the most optimal value of those parameters using some optimization process and validating the performance with some metrics (such as mean squared error to reduce the overall error). The final model is nothing but most optimal value of our parameters as selected by our learning algorithm. So in the case of simple linear regression is nothing but a tuple containing the values of our two parameters, *a* and *b*. A point to remember here is that the term parameter is analogous to coefficients or weights in a model. There are some other types of parameters called hyperparameters, which represent higher-level meta-parameters of the model and do not depend on the underlying data. They usually need to be set before we start the

building or learning process. Usually these hyperparameters are tuned to get the optimal values as a part of the model-tuning phase (a part of the learning phase itself). Another important point to remember is that the output *model* is generally dependent on the learning algorithm we choose for our data.

## Model Types

Models can be differentiated on a variety of categories and nomenclatures. A lot of this is based on the learning algorithm or method itself, which is used to build the model. Examples can be the model is linear or nonlinear, what is the output of model, whether it is a parametric model or a non-parametric model, whether it is supervised, unsupervised, or semi-supervised, whether it is an ensemble model or even a Deep Learning based model. Refer to the section “Machine Learning Methods” in Chapter 1 to refresh your memory of possible Machine Learning methods used for building models on datasets. In this section, we focus on some of the most popular models from supervised and unsupervised learning methods.

## Classification Models

Classification is one of the most readily recognizable Machine Learning tasks and it’s covered in detail in Chapter 1. It is a subset of a broader class of Machine Learning problems known as supervised learning. Supervised learning is the set of Machine Learning problems/tasks in which we have a labeled dataset with input attributes and corresponding output labels or classes (discrete). These inputs and corresponding outputs are then used in learning a generalized system, which can be used to predict results (output class labels) for previously unseen data points. Classification is one major part of the overall supervised learning domain.

The output of a classification model is normally a label or a category to which the input data point may belong. The task of solving a classification (or in general any supervised) problem involves a training set of data in which we have the data points labeled with their correct classes/categories. We then use supervised Machine Learning algorithms specific to classification problems, to generalize something similar to a classification function for our problem. The input to this classification function is exactly similar to the data that we used to train our model. This input is typically data attributes or features that are generated in the feature engineering step.

Typical classification models include the following major types of methods; however, the list is not exhaustive.

- Linear models like logistic regression, Naïve Bayes, and support vector machines
- Non-parametric models like K-nearest neighbors
- Tree based methods like decision trees
- Ensemble methods like random forests (bagging) and gradient boosted machines (boosting)
- Neural networks (MLPs)

Classification models can be further broken down on the type of output variables and the number of output variables produced by them. This nomenclature is extremely important to understand the type of classification problem you are dealing with by looking at the dataset attributes and the objective to be solved.

- **Binary classification:** When we have a total of two categories to differentiate between in the output response variable in the data, then the problem is termed as a binary classification problem. Hence you would need an appropriate model that performs binary classification (known as a binary classification model). A popular binary classification problem is the “Email classification problem”. In this problem, the candidate e-mails need to be classified and labeled into either of the two different categories: “Spam” or “Non Spam” (also known as “Ham”).
- **Multi-Class classification:** This is an extension of the binary classification problem. In this case we have more than two categories or classes into which our data can be classified. An example of the multi-class classification problem is predicting handwritten digits where a response variable can have any value ranging from 0 to 9. This becomes a 10-class classification problem. The multi-class classification is a tough problem to solve and the general scheme for solving the multi-class problem mostly involves some modifications of the binary classification problem.
- **Multi-Label classification:** These classification problems typically involve data where the output variable is not always a single value but a vector having multiple values or labels. A simple example is predicting categories of news articles that can have multiple labels for each news article like science, politics, religion, and so on.

Classification models often output the actual class labels or probabilities for each possible class label that gives a confidence level for each class in the prediction. The following are the major output formats from classification models.

- **Category classification output:** In some classification models, the output for any unknown data point is the predicted category or class label. These models usually calculate the probabilities of all the categories, but report only one class label having the maximum probability or confidence.
- **Category probability classification output:** In these classification models, the output is the probability value of each possible class label. These models are important when we want to further use the output produced by our classification model for detailed analysis or to make complex decisions. A very simple example can be a typical marketing candidate selection problem. In this problem, by getting the probability output of a potential conversion, we can narrow down our marketing expenses.

## Regression Models

In classification models, we saw that the output variable predicted by the model was a discrete value; even when we got the output as a probability value, those probability values were tied to the discrete class label values of the possible categories. Regression models are another subset of the supervised learning family of models. In these models, the input data is generally labeled with a real valued output variable (continuous instead of discrete). Regression analysis is an important part of statistical learning and it has a very similar utility, in the field of Machine Learning.

In statistical learning, regression analysis is used to find relationships between the dependent and the independent variables (which can be one or more than one). In the case of regression models, when we feed our new data points to our learned\trained *regression model*, the output of the model is a continuous value.

Based on the number of variables, the probability distribution of output variables and form of relationship (linear versus nonlinear), we have different types of regression models. The following are some of the major categories of regression models.

- **Simple linear regression:** It is the simplest of all the regression models, but it is very effective and widely used for practical purposes. In this case, we only have a single independent variable and a single dependent variable. The dependent variable is a real value and assumed to follow a normal distribution. In linear regression, while developing the model we assume a linear relationship between the independent and dependent variable.
- **Multiple linear regression:** It is the extension of the simple linear regression model, to include more than one independent variable. The other assumptions remain the same, i.e. the dependent variable is still a real value and follows a normal distribution.
- **Non linear regression:** A regression model, in which the dependent variable is dependent on nonlinear transformation of the parameters\coefficients, is termed a nonlinear regression model. It is slightly different from models in which we use a nonlinear transformation of the independent variables. Let's consider an example to make this point clear. Consider the model,  $y = \beta_0 + \beta_1 x^2 + \epsilon$ . In the previous model we have used the square of the independent variable but the parameters of the models (the *betas*, or coefficients) are still linear. Hence this model is still an example of a linear regression model, or to be more specific, a polynomial regression model. The model in which the coefficients are not linear is a model that can be termed as a nonlinear regression model. Consider an example that will fulfill this criterion and hence can be termed as a nonlinear regression model.  $y = \beta_0 + (\log \beta_1)x^2 + \epsilon$ . These models are quite hard to learn and hence not as widely used in practice. In most cases, a linear model with nonlinear transformations applied to the input variables usually suffices.

Regression models are a very important part of both statistics and Machine Learning and we encourage you to refresh your memory by checking out the “Regression” section in Chapter 1 as well as to read some standard literature on regression models to deep dive into further detailed concepts as necessary. We will be looking at regression in a future chapter dealing with a real-world case study.

## Clustering Models

We briefly talked about clustering in Chapter 1 in case you might want to refresh your memory. Clustering is a member of a different class of Machine Learning methods, known as unsupervised learning. The simplest definition of clustering is the process of grouping *similar* data points together that do not have any pre-labeled classes or categories. The output of a typical clustering process is segregated groups of data points, such that the data points in the same group are similar to each other but dissimilar from the members (data points) of other groups. The major difference between the two methods is that, unlike supervised learning, we don't have a pre-labeled set of data that we can use to train and build our model. The input set for unsupervised learning problems is generally the whole dataset itself. Another important hallmark of the unsupervised learning set of problems is that they are quite hard to evaluate, as we will see in the later part of this chapter.

Clustering models can be of different types on the basis of clustering methodologies and principles. We will briefly introduce the different types of clustering algorithms, which are as follows.

- **Partition based clustering:** A partition based clustering method is the most natural way to imagine the process of clustering. A partition based clustering method will define a notion of *similarity*. This can be any measure that can be derived from the attributes of the data points by applying mathematical functions on these attributes (features). Then, on the basis of this similarity measure, we can group data points that are similar to each other in a single group and separate the ones that are different. A partition based clustering model is usually developed using a recursive technique, i.e. we start with some arbitrary partitions of data and, based on the similarity measure, we keep reassigning data points until we reach a stable stopping criteria. Examples include techniques like K-means, K-medoids, CLARANS, and so on.
- **Hierarchical clustering:** A hierarchical clustering model is different from the partition based clustering model in the way they are developed and the way they work. In a hierarchical clustering paradigm, we either start with all the data points in one group (divisive clustering) or all the data points in different groups (agglomerative). Based on the starting point we can either keep dividing the big group into smaller groups or clusters based on some accepted similarity criteria or we can keep merging different groups or clusters into bigger ones based on the same criteria. This process is normally stopped when a decided stopping condition is achieved. Similarity criteria could be inter-data point distance in a cluster as compared to other cluster data points. Examples include Ward's minimum variance criterion based agglomerative hierarchical clustering.
- **Density based clustering:** Both the clustering models mentioned previously are quite dependent on the notion of distance. This leads to these algorithms primarily finding out spherical clusters of data. This can become a problem when we have arbitrary shaped clusters in the data. This limitation can be addressed by doing away with the concept of a distance metric based clustering. We can define a notion of "density" of data and use that to develop our cluster. The cluster development methodology then changes from finding points in the vicinity of some points to finding areas where we have some data points. This approach is not as straightforward to interpret as the distance metric approach but it leads to clusters that necessarily need not be spherical. This is very desirable trait as it is unlikely that all the clusters of interest will be spherical in shape. Examples include DBSCAN and OPTICS.

## Learning a Model

We have been talking about building models, learning parameters, and so on, since the very start of this chapter. In this section, we explain what we actually mean by the term *building a model* from the perspective of Machine Learning. In the following section, we briefly discuss the mathematical aspects of learning a model by taking a specific model as an example to make things clearer. We try to go light on the math in this section, so that you don't get overwhelmed with excess information. However, interested readers are recommended to check out any standard book on theoretical and conceptual details of Machine Learning models and their implementations (we recommend *An Introduction to Statistical Learning* by Tibshirani et al. <http://www.springer.com/in/book/9781461471370>).

## Three Stages of Machine Learning

Machine Learning can often be a complex field. We have different types of problems and tasks and different algorithms to solve them. We also have complex math, stats, and logic that form the very backbone of this diverse field. If you remember, you learned in the first chapter that Machine Learning is a combination of statistics, mathematics, optimization, linear algebra, and a bunch of other topics. But despair not; you do not need to start learning all of them right away! These diverse set of Machine Learning practices can be mostly unified by a simple three-stage paradigm. These three stages are:

- Representation
- Evaluation
- Optimization

Let's now discuss each of these steps separately to understand how almost all of the Machine Learning algorithms or methods work.

### Representation

The first stage in any Machine Learning problem is the representation of the problem in a formal language. This is where we usually define the Machine Learning task to be performed based on the data and the business objective or problem to be solved. Usually this stage of the problem is masked as another stage, which is the selection of the ML algorithm or algorithms (you might have multiple possible model representations at this phase). When we select a target algorithm, we are implicitly deciding on the representation that we want use for our problem. This stage is akin to deciding on the set of *hypothesis models*, any of which can be the solution of our problem. For example, when we decide the Machine Learning task to be performed is regression looking at our dataset and then select linear regression as our regression model. Then we have decided on the linear combination based relationship between the dependent and the independent variables. Another implicit selection made in this stage is deciding on the parameters/weights/coefficients of the model that we need to learn.

### Evaluation

Once we decide on the representation of our problem and possible set of models, we need some judging criterion or criteria that will help us choose one model over the others, or the best model from a set of candidate models. The idea is to define a metric for evaluation or a scoring function\loss function that will help enable this. This evaluation metric is generally provided in terms of an objective or an evaluation function (can also be called a loss function). What these objective functions normally do is provide a numerical performance value which will help us to decide on the effectiveness of any candidate model. The objective function depends on the type of problem we are solving, the representation we selected, and other things. A simple example would be the lower the loss or error rate, the better the model is performing.

### Optimization

The final stage in the learning process is optimization. Optimization in this case can be simply described as searching through all the hypothesis model space representations, to find the one that will give us the most optimal value of our evaluation function. While this description of optimization hides the vast majority of complexities involved in the process, it is a good way to understand the core principles. The optimization method that we will normally use is dependent on the choice of representations and the evaluation function or functions. Fortunately we already have a huge set of robust optimizers we can use once we have decided

on the representation and the evaluation aspects. Optimization methods can be methods like gradient descent and even meta-heuristical methods like generic algorithms.

## The Three Stages of Logistic Regression

The best way to understand the nuances of a complex process is to explain it using an example. In this section, we trace the three stages of the Machine Learning process, using the logistic regression model. Logistic regression is an extension of linear regression to solve classification problems. We will see how a simple logistic regression problem is solved using a gradient descent based optimization, which is one of the most popular optimization methods.

### Representation

The representation of a logistic regression is obtained by applying the logit function to the representation of linear regression model. The linear regression representation is given by this hypothesis function:

$$h(\theta) = \theta^T x$$

Here,  $\theta$  represents the parameters of the model and  $x$  is the input vector. The logit function is given by:

$$\sigma(t) = \frac{1}{1 + e^{-t}}$$

Applying the logit function on the representation of linear regression gives us the representation of logistic regression.

$$h(\theta) = \frac{1}{1 + e^{-\theta^T x}}$$

This is our representation for the logistic regression model. As the value of logit function ranges between 0 and 1, we can decide between the two categories by supplying an input vector  $x$  and a set of parameters  $\theta$  and calculating the value of  $h(\theta)$ . If it is less than 0.5 then typically the label is 0; otherwise, the label is 1 (binary classification problems leverage this).

### Evaluation

The next step in the process is specifying an evaluation or cost function. The cost function in our case is dependent on the actual class of the data point. Suppose the output of the logit function is 0.75 for a data point whose class is 1, then the error or loss of that case is 0.25. But if that data point is of category 0 then the error is 0.75. Using this analogy, we can define the cost function for one data point as follows.

$$cost(h_\theta(x), y) = \begin{cases} -\log(h_\theta(x)), & \text{if } y=1 \\ -\log(1-h_\theta(x)), & \text{if } y=0 \end{cases}$$

Leveraging the previous logic, the cost function for the whole dataset is given by:

$$cost(\theta) = l(\theta) = \sum_{i=1}^m y^i \log(h(x^i)) + (1 - y^i) \log(1 - h(x^i))$$



## Optimization

The cost function we described earlier is a function of  $\theta$  and hence we need to maximize the previous function and find the set of  $\theta$  that gives us the maximum value (normally we will minimize the cost function, but here we have taken a log and hence we will maximize the log function). The value  $\theta$  that we obtain by represents the model (parameters) that we wanted to learn.

The basic idea of maximizing or minimizing a function is that you differentiate the function and find the point where the gradient is zero. That is the point where the function is taking either a minimum or a maximum value. But we have to keep in mind that the function that we have is a nonlinear function in the parameter  $\theta$ . Hence we won't be able to directly solve for the optimal values of  $\theta$ . This is where we introduce the concept of the gradient descent method.

In the simplest terms, gradient descent is the process in which we calculate the gradient of the function we want to optimize at each point and then keep moving in the direction of negative gradient values. Here by moving, we mean to update the values of  $\theta$  according to the gradient that we calculate.

We can calculate the gradient of the cost function with respect to each component of the parameter vector as follows:

$$\frac{\partial}{\partial \theta_j} = (y - h_\theta(x))x_j$$

By repeating this calculation for each of the component of parameter vector, we can calculate the gradient of the function with respect to the whole parameter vector. Once we get the gradient, the next step is to update the new set of parameter vector values using this equation.

$$\theta_j := \theta_j + \alpha \left( (y^i - h_\theta(x^i))x_j^i \right)$$

Here,  $\alpha$  represents the small step we want to take in the direction of the gradient.  $\alpha$  is a hyperparameter of the optimization process (you can think of it as a learning rate or learning step size) and its value can determine whether we reach a global minima or a local one.

If we keep reiterating the process, we will reach a point where our cost function will not change much irrespective of any small update that we make to values of  $\theta$ . Using this method, we can obtain the optimal set of parameter values.

Keep in mind that this is a simple description of gradient to make things easy to understand and interpret. Usually there are many other considerations involved in solving an optimization problem and a vast set of challenges. The main intent of this section is to make you aware of how optimization is an essential part of any Machine Learning problem.

## Model Building Examples

The future chapters of this book are dedicated to build and tune models on real-world datasets. So we will be doing a lot of model building, tuning, and evaluation in general. In this section, we want to depict some examples of each category of models that we discussed in the previous section. This will serve as a ready reckoner starting guide for our model building exploits in the future.

## Classification

In all classification (or supervised learning) problems, the first step after preparing the whole dataset is to segregate the data into a testing and a training set and optionally a validation set. The idea is to make the model learn by training it on the `train` dataset, evaluate and tune it on the `validation` dataset, or use techniques like cross validation and finally check its performance on the `test` dataset. You will learn in the model evaluation section of this chapter that evaluating a model is a critical part of any Machine Learning solution. Hence, as a rule of thumb, we must always remember that the actual evaluation of a Machine Learning algorithm is always on the data that it has not previously seen (even cross validation on the training dataset will use a part of the `train` data for model building and the rest for evaluation).

Sometimes we will use the whole dataset to train the model and then use some subset of it as a test set. This is a common mistake done by many of us often in Machine Learning. To accurately analyze a model, it must generalize well and perform well on data that it has never seen before. A good evaluation metric on training data but a bad performance on unseen (validation or test) data means that the algorithm has failed to produce a generalized solution for the problem (more on this later).

For our classification example, we will use a popular multi-class classification problem we talked about earlier, handwritten digit recognition. The data for the same is available as part of the `scikit-learn` library. The problem here is to predict the actual digit value from a handwritten image of a digit. In its original form the problem comes in the domain of image based classification and computer vision. In the dataset we have is a `1x64` feature vector, which represents the image representation of a grey scale image of the handwritten digit.

Before we proceed to building any model, let's first see how both the data and the image we intend to analyze look. The following code will load the data for the image at index 10 and plot it.

```
In [2]: from sklearn import datasets
...: import matplotlib.pyplot as plt
...: %matplotlib inline

...: digits = datasets.load_digits()
...:
...: plt.figure(figsize=(3, 3))
...: plt.imshow(digits.images[10], cmap=plt.cm.gray_r)
```

The image generated by the code is depicted in Figure 5-2. Any guesses as to which number it represents?

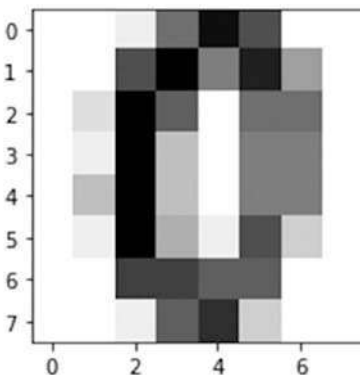

**Figure 5-2.** Handwritten digit data representing the digit zero

We can determine how the raw pixel data looks the flattened vector representation and the number (class label), which is represented by the image using the following code.

```
# actual image pixel matrix
In [3]: digits.images[10]
Out[3]:
array([[ 0.,  0.,  1.,  9., 15., 11.,  0.,  0.],
       [ 0.,  0., 11., 16.,  8., 14.,  6.,  0.],
       [ 0.,  2., 16., 10.,  0.,  9.,  9.,  0.],
       [ 0.,  1., 16.,  4.,  0.,  8.,  8.,  0.],
       [ 0.,  4., 16.,  4.,  0.,  8.,  8.,  0.],
       [ 0.,  1., 16.,  5.,  1., 11.,  3.,  0.],
       [ 0.,  0., 12., 12., 10., 10.,  0.,  0.],
       [ 0.,  0.,  1., 10., 13.,  3.,  0.,  0.]])

# flattened vector
In [4]: digits.data[10]
Out[4]:
array([ 0.,  0.,  1.,  9., 15., 11.,  0.,  0.,  0.,  0., 11., 16.,  8., 14.,
        6.,  0.,  0.,  2., 16., 10.,  0.,  9.,  9.,  0.,  0.,  1., 16.,  4.,
        0.,  8.,  8.,  0.,  0.,  4., 16.,  4.,  0.,  8.,  8.,  0.,  0.,  1.,
        16.,  5.,  1., 11.,  3.,  0.,  0.,  0., 12., 12., 10., 10.,  0.,  0.,
        0.,  0.,  1., 10., 13.,  3.,  0.,  0.]])

# image class label
In [5]: digits.target[10]
Out[5]: 0
```

We will later see that we can frame this problem in a variety of ways. But for this tutorial we will use a logistic regression model to do this classification. Before we proceed to model building, we will split the dataset into separate test and train sets. The size of the test set is generally dependent on the total amount of data available. In our example, we will use a test set, which is 30% of the overall dataset. The total data points in each dataset is printed for ease of understanding

```
In [12]: X_digits = digits.data
...: y_digits = digits.target
...:
...: num_data_points = len(X_digits)
...:
...: X_train = X_digits[:int(.7 * num_data_points)]
...: y_train = y_digits[:int(.7 * num_data_points)]
...: X_test = X_digits[int(.7 * num_data_points):]
...: y_test = y_digits[int(.7 * num_data_points):]
...: print(X_train.shape, X_test.shape)
(1257, 64) (540, 64)
```

From the preceding output, we can see our train dataset has 1257 data points and the test dataset has 540 data points. The next step in the process is specifying the model that we will be using and the hyperparameter values that we want to use. The values of these hyperparameters do not depend on the underlying data and are usually set prior to model training and are fine tuned for extracting the best model. You will learn about tuning later on in this chapter. For the time being, we will use the default values as depicted when we initialize the model estimator and fit our model on the training set.

```
In [14]: from sklearn import linear_model
...:
...: logistic = linear_model.LogisticRegression()
...: logistic.fit(X_train, y_train)
LogisticRegression(C=1.0, class_weight=None, dual=False, fit_intercept=True,
intercept_scaling=1, max_iter=100, multi_class='ovr', n_jobs=1,
penalty='l2', random_state=None, solver='liblinear', tol=0.0001,
verbose=0, warm_start=False)
```

You can see various hyperparameters and parameters of the model depicted in the preceding output. Let's now test the accuracy of this model on the test dataset.

```
In [15]: print('Logistic Regression mean accuracy: %f' % logistic.score(X_test, y_test))
Logistic Regression mean accuracy: 0.900000
```

This is all it takes in `scikit-learn` to fit a model like logistic regression. In the first step, we identified the model that we wanted to use which in our case was a linear model, called logistic regression. Then we called the `fit` method of that object with our training data and its output labels. The `fit` method updates the model object with the learned parameters of the model. We then used the `score` method of the object to determine the accuracy of the fitted model on our test set. So the model we developed without any intensive tuning is 90% accurate at predicting handwritten digits.

This concludes our very basic example of fitting a classification model on our dataset. Note that our dataset was in a fully processed and cleaned format. You need to ensure your data is in the same way before you proceed to fit any models on it when solving any problem.

## Clustering

In this section, you will learn how we can fit a clustering model on another dataset. In the example which we will pick, we will use a labeled dataset to help us see the results of the clustering model and compare it with actual labels. A point to remember here is that, usually labeled data is not available in the real world, which is why we choose to go for unsupervised methods like clustering. We will try to cover two different algorithms, one each from partitioning based clustering and hierarchical clustering.

The data that we will use for our clustering example will be the very popular Wisconsin Diagnostic Breast Cancer dataset, which we covered in detail in Chapter 4 in the section “Feature Selection and Dimensionality Reduction”. Do check out those sections to refresh your memory. This dataset has 30 attributes or features and a corresponding label for each data point (breast mass) depicting if it has cancer (malignant: label value 0) or no cancer (benign: label value 1). Let's load the data using the following code.

```
import numpy as np
from sklearn.datasets import load_breast_cancer

# load data
data = load_breast_cancer()
X = data.data
y = data.target
print(X.shape, data.feature_names)
(569, 30) ['mean radius' 'mean texture' 'mean perimeter' ... 'worst fractal dimension']
```

It is evident that we have a total of 569 observations and 30 attributes or features for each observation.

## Partition Based Clustering

We will choose the simplest yet most popular partition based clustering model for our example, which is K-means algorithm. This algorithm is a centroid based clustering algorithm, which starts with some assumption about the total clusters in the data and with random centers assigned to each of the clusters. It then reassigns each data point to the center closest to it, using Euclidean distance as the distance metric. After each reassignment, it recalculates the center of that cluster. The whole process is repeated iteratively and stopped when reassignment of data points doesn't change the cluster centers. Variants include algorithms like K-medoids.

Since we already know from the data labels that we have two possible types of categories either 0 or 1, the following code tries to determine these two clusters from the data by leveraging K-means clustering. In the real world, this is not always the case, since we will not know the possible number of clusters. This is one of the most important downsides of K-means clustering.

```
from sklearn.cluster import KMeans

km = KMeans(n_clusters=2)
km.fit(X)

labels = km.labels_
centers = km.cluster_centers_
print(labels[:10])
[0 0 0 1 0 1 0 1 1 1]
```

Once the fit process is complete we can get the centers and labels of our two clusters in the dataset by using the preceding attributes. The *centers* here refer to some numerical value of the dimensions of the data (the 30 attributes in the dataset) around which data is clustered.

But can we visualize and compare the clusters with the actual labels? Remember we are dealing with 30 features and visualizing the clusters on a 30-dimensional feature space would be impossible to interpret or even perform. Hence, we will leverage PCA to reduce the input dimensions to two principal components and visualize the clusters on top of the same. Refer to Chapter 4 to learn more about principal component analysis.

```
from sklearn.decomposition import PCA

pca = PCA(n_components=2)
bc_pca = pca.fit_transform(X)
```

The following code helps visualize the clusters on the reduced 2D feature space for the actual labels as well as the clustered output labels.

```
fig, (ax1, ax2) = plt.subplots(1, 2, figsize=(8, 4))
fig.suptitle('Visualizing breast cancer clusters')
fig.subplots_adjust(top=0.85, wspace=0.5)
ax1.set_title('Actual Labels')
ax2.set_title('Clustered Labels')

for i in range(len(y)):
    if y[i] == 0:
        c1 = ax1.scatter(bc_pca[i,0], bc_pca[i,1],c='g', marker='.')
    if y[i] == 1:
        c2 = ax1.scatter(bc_pca[i,0], bc_pca[i,1],c='r', marker='.')
```

```

if labels[i] == 0:
    c3 = ax2.scatter(bc_pca[i,0], bc_pca[i,1],c='g', marker='.')
if labels[i] == 1:
    c4 = ax2.scatter(bc_pca[i,0], bc_pca[i,1],c='r', marker='.')

l1 = ax1.legend([c1, c2], ['0', '1'])
l2 = ax2.legend([c3, c4], ['0', '1'])

```

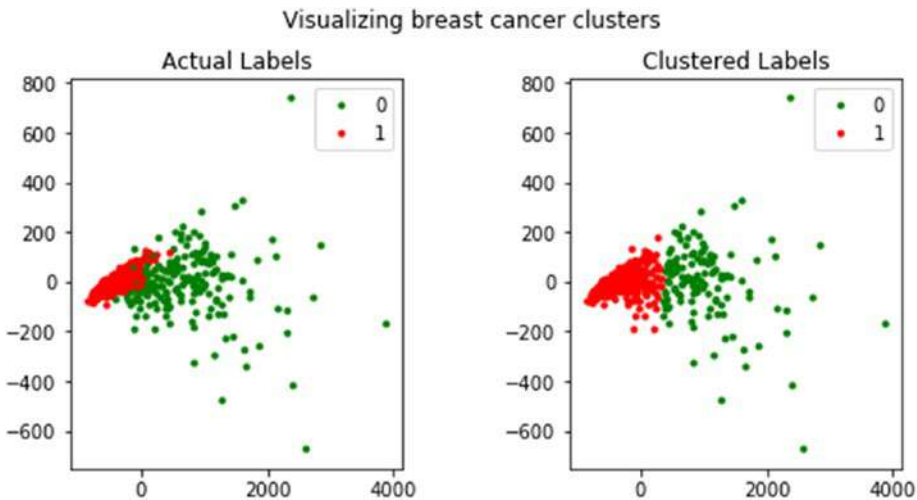

**Figure 5-3.** Visualizing clusters in the breast cancer dataset

From Figure 5-3, you can clearly see that the clustering has worked quite well and it shows distinct separation between clusters with labels 0 and 1 and is quite similar to the actual labels. However we do have some overlap where we have mislabeled some instances, which is evident in the plot on the right. Remember in an actual real-world scenario, you will not have the actual labels to compare with and the main idea is to find structures or patterns in your data in the form of these clusters. Another very important point to remember is that cluster label values have no significance. The labels 0 and 1 are just values to distinguish cluster data points from each other. If you run this process again, you can easily obtain the same plot with the labels reversed. Hence even when dealing with labeled data and running clustering do not compare clustered label values with actual labels and try to measure accuracy. Also another important note is that if we had asked for more than two clusters, the algorithm would have readily supplied more clusters but it would have been hard to interpret those and many of them would not make sense. Hence, one of the caveats of using the K-means algorithm is to use it in the case where we have some idea about the total number of clusters that may exist in the data.

## Hierarchical Clustering

We can use the same data to perform a hierarchical clustering and see if the results change much as compared to K-means clustering and the actual labels. In `scikit-learn` we have a multitude of interfaces like the `AgglomerativeClustering` class to perform hierarchical clustering. Based on what we discussed earlier in this chapter as well as in Chapter 1, agglomerative clustering is hierarchical clustering using a bottom up approach i.e. each observation starts in its own cluster and clusters are successively merged together. The merging criteria can be used from a candidate set of linkages; the selection of linkage governs the merge strategy. Some examples of linkage criteria are Ward, Complete linkage, Average linkage and so on. We will leverage low-level functions from `scipy` however because we still need to mention the number of clusters in the `AgglomerativeClustering` interface which we want to avoid. Since we already have the breast cancer feature set in variable `X`, the following code helps us compute the linkage matrix using Ward's minimum variance criterion.

```
from scipy.cluster.hierarchy import dendrogram, linkage
import numpy as np
np.set_printoptions(suppress=True)

Z = linkage(X, 'ward')
print(Z)

[[ 287.         336.         3.81596727    2.         ]
 [ 106.         420.         4.11664267    2.         ]
 [  55.         251.         4.93361024    2.         ]
 ...,
 [ 1130.        1132.         6196.07482529   86.         ]
 [ 1131.        1133.         8368.99225244  483.         ]
 [ 1134.        1135.        18371.10293626  569.         ]]
```

On seeing the preceding output, you might think what does this linkage matrix indicate? You can think of the linkage matrix as a complete historical map, keeping track of which data points were merged into which cluster during each iteration. If you have  $n$  data points, the linkage matrix,  $Z$  will be having a shape of  $(n - 1) \times 4$  where  $Z[i]$  will tell us which clusters were merged at the  $i^{\text{th}}$  iteration. Each row has four elements, the first two elements are either data point identifiers or cluster labels (in the later parts of the matrix once multiple data points are merged), the third element is the cluster distance between the first two elements (either data points or clusters), and the last element is the total number of elements\data points in the cluster once the merge is complete. We recommend you refer to <https://docs.scipy.org/doc/scipy/reference/generated/scipy.cluster.hierarchy.linkage.html>, which explains this in detail. The best way to visualize these distance-based merges is to use a dendrogram, as shown in Figure 5-4.

```
plt.figure(figsize=(8, 3))
plt.title('Hierarchical Clustering Dendrogram')
plt.xlabel('Data point')
plt.ylabel('Distance')
dendrogram(Z)
plt.axhline(y=10000, c='k', ls='--', lw=0.5)
plt.show()
```

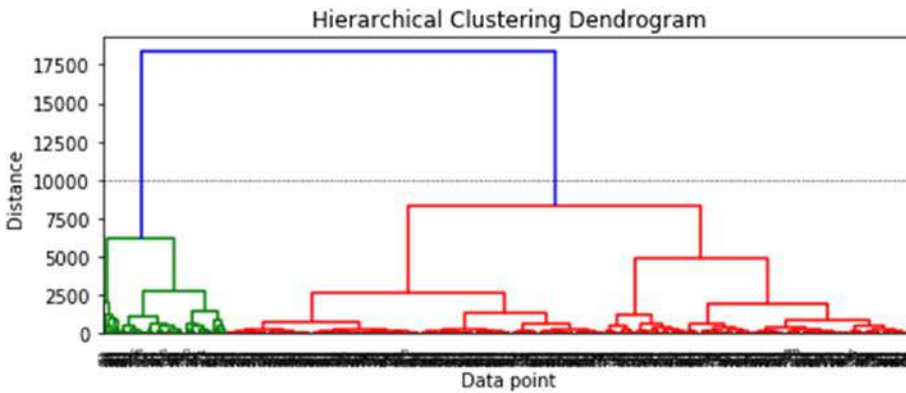

**Figure 5-4.** Visualizing the hierarchical clustering dendrogram

In the dendrogram depicted in Figure 5-4, we can see how each data point starts as an individual cluster and slowly starts getting merged with other data points to form clusters. On a high level from the colors and the dendrogram, you can see that the model has correctly identified two major clusters if you consider a distance metric of around 10000 or above. Leveraging this distance, we can get the cluster labels using the following code.

```
from scipy.cluster.hierarchy import fcluster

max_dist = 10000
hc_labels = fcluster(Z, max_dist, criterion='distance')
```

Let’s compare how the cluster outputs look based on the PCA reduced dimensions as compared to the original label distribution (detailed code is in the notebook). See Figure 5-5.

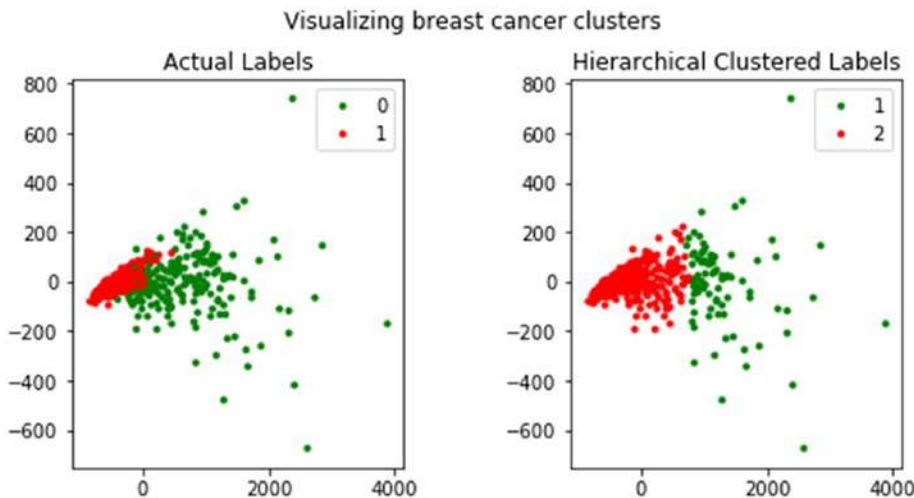

**Figure 5-5.** Visualizing hierarchical clusters in the breast cancer dataset



We definitely see two distinct clusters but there is more overlap as compared to the K-means method between the two clusters and we have more mislabeled instances. However, do take a note of the label numbers; here we have 1 and 2 as the label values. This is just to reinforce the fact that the label values are just to distinguish the clusters and don't mean anything. The advantage of this method is that you do not need to input the number of clusters beforehand and the model tries to find it from the underlying data.

## Model Evaluation

We have seen the process of data retrieval, processing, wrangling and modeling based on various requirements. A logical question that follows is how we can make the judgment whether a model is good or bad? Just because we have developed something fancy using a renowned algorithm, doesn't guarantee its performance will be great. Model evaluation is the answer to these questions and is an essential part of the whole Machine Learning pipeline. We have mentioned it quite a number of times in that past about how model development is an iterative process. Model evaluation is the defining part of the iterative process which makes it iterative in nature. Based on model evaluation and subsequent comparisons we can take a call whether to continue our efforts in model enhancement or cease them and which model should be selected as the final model to be used\deployed. Model evaluation also helps us in the very important process of tuning the hyperparameters of the model and also deciding scenarios like, if the intelligent *feature* that we just developed is adding any value to our model or not. Combining all these arguments makes a compelling case for having a defined process for model evaluation and what metrics can be used to measuring and evaluating models.

So how can we evaluate a model? How can we make a decision whether Model A is better or Model B performs better? The ideal way is to have some numerical measure or metric of a model's effectiveness and use that measure to rank and select models. This will be one of the primary ways for us to evaluate models but we should also keep in mind that a lot of times these evaluation metrics may not capture the required success criteria of the problem we are trying to solve. In these cases, we will be required to become imaginative and adapt these metrics to our problem and use things like business constraints and objectives.

Model evaluation metrics are highly dependent on the type of model we have, so metrics for regression models will be different from the classification models or clustering models. Considering this dependency we will break this section down in three sub-sections. We cover the major model evaluation metrics for three categories of models.

## Evaluating Classification Models

Classification models are one of the most popular models among Machine Learning practitioners. Due to their popularity, it is essential to know how to build good quality, generalized models. They have a varied set of metrics that can be used to evaluate classification models. In this section, we target a small subset of those metrics that are essential. We use the models that we developed in the previous section to illustrate them in detail. For this, let's first prepare train and test datasets to build our classification models. We will be leveraging the X and y variables from before, which holds the data and labels for the breast cancer dataset observations.

```
from sklearn.model_selection import train_test_split

X_train, X_test, y_train, y_test = train_test_split(X, y, test_size=0.3, random_state=42)
print(X_train.shape, X_test.shape)
(398, 30) (171, 30)
```

From the preceding output, it is clear that we have 398 observations in our train dataset and 171 observations in our test dataset. We will be leveraging a nifty module we have created for model evaluation. It is named `model_evaluation_utils` and you can find it along with the code files and notebooks for this chapter. We recommend you to check out the code, which leverages the `scikit-learn` `metrics` module to compute most of the evaluation metrics and plots.

## Confusion Matrix

Confusion matrix is one of the most popular ways to evaluate a classification model. Although the matrix by itself is not a metric, the matrix representation can be used to define a variety of metrics, all of which become important in some specific case or scenario. A confusion matrix can be created for a binary classification as well as a multi-class classification model.

A confusion matrix is created by comparing the predicted class label of a data point with its actual class label. This comparison is repeated for the whole dataset and the results of this comparison are compiled in a matrix or tabular format. This resultant matrix is our confusion matrix. Before we go any further, let's build a logistic regression model on our breast cancer dataset and look at the confusion matrix for the model predictions on the test dataset.

```
from sklearn import linear_model
# train and build the model
logistic = linear_model.LogisticRegression()
logistic.fit(X_train,y_train)

# predict on test data and view confusion matrix
import model_evaluation_utils as meu

y_pred = logistic.predict(X_test)
meu.display_confusion_matrix(true_labels=y_test, predicted_labels=y_pred, classes=[0, 1])
```

```

      Predicted:
                0    1
Actual: 0      59    4
         1      2  106
```

The preceding output depicts the confusion matrix with necessary annotations. We can see that out of 63 observations with label 0 (malignant), our model has correctly predicted 59 observations. Similarly out of 108 observations with label 1 (benign), our model has correctly predicted 106 observations. More detailed analysis is coming right up!

## Understanding the Confusion Matrix

While the name itself sounds pretty overwhelming, understanding the confusion matrix is not that confusing once you have the basics right! To reiterate what you learned in the previous section, the confusion matrix is a tabular structure to keep a track of correct classifications as well as misclassifications. This is useful to evaluate the performance of a classification model for which we know the true data labels and can compare with the predicted data labels. Each column in the confusion matrix represents classified instance counts based on predictions from the model and each row of the matrix represents instance counts based on the actual\true class labels. This structure can also be reversed, i.e. predictions depicted by rows and true labels by columns. In a typical binary classification problem, we usually have a class label which defined as the positive class which is basically the class of our interest. For instance in our breast cancer dataset, let's say we

are interested in detecting or predicting when the patient does not have breast cancer (benign). Then label 1 is our positive class. However, suppose our class of interest was to detect cancer (malignant) then we could have chosen label 0 as our positive class. Figure 5-6 shows a typical confusion matrix for a binary classification problem, where  $p$  denotes the positive class and  $n$  denotes the negative class.

		PREDICTED LABELS	
		$n'$ (Predicted)	$p'$ (Predicted)
TRUE LABELS	$n$ (True)	<b>True Negative</b> (Number of instances of negative class ' $n$ ' correctly predicted)	<b>False Positive</b> <i>(Number of instances of negative class '<math>n</math>' incorrectly predicted as the positive class '<math>p</math>' )</i>
	$p$ (True)	<b>False Negative</b> <i>(Number of instances of positive class '<math>p</math>' incorrectly predicted as the negative class '<math>n</math>' )</i>	<b>True Positive</b> <i>(Number of instances of positive class '<math>p</math>' correctly predicted)</i>

**Figure 5-6.** Typical structure of a confusion matrix

Figure 5-6 should make things more clear with regard to the structure of confusion matrices. In general, we usually have a positive class as we discussed earlier and the other class is the negative class. Based on this structure, we can clearly see four terms of importance.

- **True Positive (TP):** This is the count of the total number of instances from the positive class where the true class label was equal to the predicted class label, i.e. the total instances where we correctly predicted the positive class label with our model.
- **False Positive (FP):** This is the count of the total number of instances from the negative class where our model misclassified them by predicting them as positive. Hence the name, false positive.
- **True Negative (TN):** This is the count of the total number of instances from the negative class where the true class label was equal to the predicted class label, i.e. the total instances where we correctly predicted the negative class label with our model.
- **False Negative (FN):** This is the count of the total number of instances from the positive class where our model misclassified them by predicting them as negative. Hence the name, false negative.

Thus based on this information, can you compute the previously mentioned metrics for our confusion matrix based on the model predictions on the breast cancer test data?

```
positive_class = 1
TP = 106
FP = 4
TN = 59
FN = 2
```

## Performance Metrics

The confusion matrix by itself is not a performance measure for classification models. But it can be used to calculate several metrics that are useful measures for different scenarios. We will describe how the major metrics can be calculated from the confusion matrix, compute them manually using necessary formulae, and then compare the results with functions provided by `scikit-learn` on our predicted results and give an intuition of scenarios where each of those metric can be used.

**Accuracy:** This is one of the most popular measures of classifier performance. It is defined as the overall accuracy or proportion of correct predictions of the model. The formula for computing accuracy from the confusion matrix is:

$$Accuracy = \frac{TP + TN}{TP + FP + TN + FN}$$

Accuracy measure is normally used when our classes are almost balanced and correct predictions of those classes are equally important. The following code computes accuracy on our model predictions.

```
fw_acc = round(meu.metrics.accuracy_score(y_true=y_test, y_pred=y_pred), 5)
mc_acc = round((TP + TN) / (TP + TN + FP + FN), 5)
print('Framework Accuracy:', fw_acc)
print('Manually Computed Accuracy:', mc_acc)
```

```
Framework Accuracy: 0.96491
Manually Computed Accuracy: 0.96491
```

**Precision:** Precision, also known as positive predictive value, is another metric that can be derived from the confusion matrix. It is defined as the number of predictions made that are actually correct or relevant out of all the predictions based on the positive class. The formula for precision is as follows:

$$Precision = \frac{TP}{TP + FP}$$

A model with high precision will identify a higher fraction of positive class as compared to a model with a lower precision. Precision becomes important in cases where we are more concerned about finding the maximum number of positive class even if the total accuracy reduces. The following code computes precision on our model predictions.

```
fw_prec = round(meu.metrics.precision_score(y_true=y_test, y_pred=y_pred), 5)
mc_prec = round((TP) / (TP + FP), 5)
print('Framework Precision:', fw_prec)
print('Manually Computed Precision:', mc_prec)
```

```
Framework Precision: 0.96364
Manually Computed Precision: 0.96364
```

**Recall:** Recall, also known as sensitivity, is a measure of a model to identify the percentage of relevant data points. It is defined as the number of instances of the positive class that were correctly predicted. This is also known as hit rate, coverage, or sensitivity. The formula for recall is:

$$\text{Recall} = \frac{TP}{TP + FN}$$

Recall becomes an important measure of classifier performance in scenarios where we want to catch the most number of instances of a particular class even when it increases our false positives. For example, consider the case of bank fraud, a model with high recall will give us higher number of potential fraud cases. But it will also help us raise alarm for most of the suspicious cases. The following code computes recall on our model predictions.

```
fw_rec = round(meu.metrics.recall_score(y_true=y_test, y_pred=y_pred), 5)
mc_rec = round((TP) / (TP + FN), 5)
print('Framework Recall:', fw_rec)
print('Manually Computed Recall:', mc_rec)
```

```
Framework Recall: 0.98148
Manually Computed Recall: 0.98148
```

**F1 Score:** There are some cases in which we want a balanced optimization of both precision and recall. F1 score is a metric that is the harmonic mean of precision and recall and helps us optimize a classifier for balanced precision and recall performance.

The formula for the F1 score is:

$$F1 \text{ Score} = \frac{2 \times \text{Precision} \times \text{Recall}}{\text{Precision} + \text{Recall}}$$

Let's compute the F1 score on the predictions made by our model using the following code.

```
fw_f1 = round(meu.metrics.f1_score(y_true=y_test, y_pred=y_pred), 5)
mc_f1 = round((2*mc_prec*mc_rec) / (mc_prec+mc_rec), 5)
print('Framework F1-Score:', fw_f1)
print('Manually Computed F1-Score:', mc_f1)
```

```
Framework F1-Score: 0.97248
Manually Computed F1-Score: 0.97248
```

Thus you can see how our manually computed metrics match the results obtained from the scikit-learn functions. This should give you a good idea of how to evaluate classification models with these metrics.

## Receiver Operating Characteristic Curve

ROC which stands for Receiver Operating Characteristic is a concept from early Radar days. This concept can be extended to evaluation of binary classifiers as well as multi-class classifiers (Note that to adapt the ROC curve for multi-class classifiers we have to use one-vs-all scheme and averaging techniques like macro and micro averaging.) It can be interpreted as the effectiveness with which the model can distinguish between actual signal and the noise in the data.

The ROC curve can be created by plotting the fraction of true positives versus the fraction of false positives, i.e. it is a plot of True Positive Rate (TPR) versus the False Positive Rate (FPR). It is applicable mostly for *scoring* classifiers. Scoring classifiers are the type of classifiers which will return a probability value or score for each class label, from which a class label can be deduced (based on maximum probability value). This curve can be plotted using the true positive rate (TPR) and the false positive rate (FPR) of a classifier. TPR is known as sensitivity or recall, which is the total number of correct positive results, predicted among all the positive samples the dataset. FPR is known as false alarms or (1 - specificity), determining the total number of incorrect positive predictions among all negative samples in the dataset. Although we will rarely be plotting the ROC curve manually, it is always a good idea to understand how they can be plotted. The following steps can be followed to plot a ROC curve given the class label probabilities of each data point and their correct or true labels.

1. Order the outputs of the classifier by their scores (or the probability of being the positive class).
2. Start at the (0, 0) coordinate.
3. For each example  $x$  in the sorted order:
  - If  $x$  is positive, move  $\frac{1}{pos}$  up
  - If  $x$  is negative, move  $\frac{1}{neg}$  right

Here *pos* and *neg* are the fraction of positive and negative examples respectively. The idea is that typically in any ROC curve, the ROC space is between points (0, 0) and (1, 1). Each prediction result from the confusion matrix occupies one point in this ROC space. Ideally, the best prediction model would give a point on the top left corner (0, 1) indicating perfect classification (100% sensitivity & specificity). A diagonal line depicts a classifier that does a random guess. Ideally if your ROC curve occurs in the top half of the graph, you have a decent classifier which is better than average. You can always leverage the `roc_curve` function provided by `scikit-learn` to generate the necessary data for an ROC curve. Refer to [http://scikit-learn.org/stable/auto\\_examples/model\\_selection/plot\\_roc.html](http://scikit-learn.org/stable/auto_examples/model_selection/plot_roc.html) for further details. Figure 5-7 shows a sample ROC curve from the link we just mentioned.

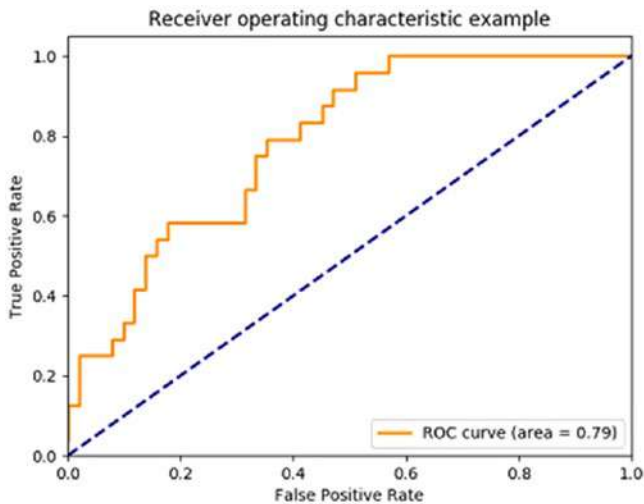

**Figure 5-7.** Sample ROC Curve (Source: [http://scikit-learn.org/stable/modules/model\\_evaluation.html#roc-metrics](http://scikit-learn.org/stable/modules/model_evaluation.html#roc-metrics))

Figure 5-7 depicts the sample ROC curve. In general, the ROC curve is an important tool for visually interpreting classification models. But it doesn't directly provide us with a numerical value that we can use to compare models. The metric which does that task is the *Area Under Curve* popularly known as AUC. In the ROC plot in Figure 5-7, the area under the orange line is the area under the classifier's ROC curve. The ideal classifier will have the unit area under the curve. Based on this value we can compare two models, generally the model with the AUC score is a better one. We have built a generic function for plotting ROC curves with AUC scores for binary as well as multi-class classification problems in our `model_evaluation_utils` module. Do check out the function, `plot_model_roc_curve(...)` to know more about it. The following code plots the ROC curve for our breast cancer logistic regression model leveraging the same function.

```
meu.plot_model_roc_curve(clf=logistic, features=X_test, true_labels=y_test)
```

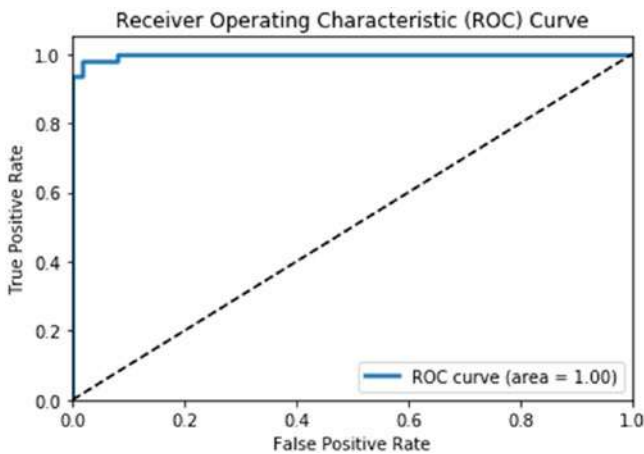

**Figure 5-8.** ROC curve for our logistic regression model

Considering our model has an accuracy and F1 Score of around 97%, Figure 5-8 makes sense where we see a near perfect ROC curve! Check out Chapter 9 to see a multi-class classifier ROC curve in action!

## Evaluating Clustering Models

We discussed some of the popular ways to evaluate classification models in the previous section. The confusion matrix alone provided us with a bunch of metrics that we can use to compare classification models. The tables are turned drastically when it comes to evaluating clustering (or unsupervised models in general). This difficulty arises from the lack of a validated ground truth in case of unsupervised models, i.e. the absence of true labels in the data. In this section, you learn about some of the methods/metrics we can use to evaluate the performance of our clustering models.

To illustrate the evaluation metrics with a real-world example, we will leverage the breast cancer dataset available in the variables  $X$  for the data and  $y$  for the observation labels. We will also use the K-means algorithm to fit two models on this data—one with two clusters and the second one with five clusters—and then evaluate their performance.

```
km2 = KMeans(n_clusters=2, random_state=42).fit(X)
km2_labels = km2.labels_
```

```
km5 = KMeans(n_clusters=5, random_state=42).fit(X)
km5_labels = km5.labels_
```

## External Validation

External validation means validating the clustering model when we have some ground truth available as labeled data. The presence of external labels reduces most of the complexity of model evaluation as the clustering (unsupervised) model can be validated in similar fashion to classification models. Recall the breast cancer dataset example that we took in the first section of this chapter, we ran the labeled data through a clustering algorithm. In that case we had two classes and we got two clusters from our algorithm. However evaluating the performance is not as straightforward as classification algorithms.



If you remember our discussion earlier on cluster labels, they are just indicators used to distinguish data points from each other based on which cluster or group they fall into. Hence we cannot compare a cluster with label 0 directly with a true class label 0. It is possible that all data points with true class label of 0 were actually clustered with label 1 during the clustering process. Based on this, we can leverage several metrics to validate clustering performance when we have the true labels available. Three popular metrics can be used in this scenario:

- **Homogeneity:** A clustering model prediction result satisfies homogeneity if all of its clusters contain only data points that are members of a single class (based on the true class labels).
- **Completeness:** A clustering model prediction result satisfies completeness if all the data points of a specific ground truth class label are also elements of the same cluster.
- **V-measure:** The harmonic mean of homogeneity and completeness scores gives us the V-measure value.

Values are typically bounded between 0 and 1 and usually higher values are better. Let's compute these metric on our two K-means clustering models.

```
km2_hcv = np.round(metrics.homogeneity_completeness_v_measure(y, km2_labels), 3)
km5_hcv = np.round(metrics.homogeneity_completeness_v_measure(y, km5_labels), 3)

print('Homogeneity, Completeness, V-measure metrics for num clusters=2: ', km2_hcv)
print('Homogeneity, Completeness, V-measure metrics for num clusters=5: ', km5_hcv)

Homogeneity, Completeness, V-measure metrics for num clusters=2: [ 0.422  0.517  0.465]
Homogeneity, Completeness, V-measure metrics for num clusters=5: [ 0.602  0.298  0.398]
```

We can see that the V-measure for the first model with two clusters is better than the one with five clusters and the reason is because of higher completeness score. Another metric you can try out includes the Fowlkes-Mallows score.

## Internal Validation

Internal validation means validating a clustering model by defining metrics that capture the expected behavior of a good clustering model. A good clustering model can be identified by two very desirable traits:

- Compact groups, i.e. the data points in one cluster occur *close* to each other.
- Well separated groups, i.e. two groups\clusters have as large distance among them as possible.

We can define metrics that mathematically calculate the goodness of these two major traits and use them to evaluate clustering models. Most of such metrics will use some concept of *distance between data points*. The distance between data points can be defined using any candidate distance metric ranging from a Euclidian distance, Manhattan distance, or any metric that meets the criteria for being a distance metric.

## Silhouette Coefficient

Silhouette coefficient is a metric that tries to combine the two requirements of a good clustering model. The silhouette coefficient is defined for each sample and is a combination of its similarity to the data points in its own cluster and its dissimilarity to the data points not in its cluster.

The mathematical formula of silhouette coefficient for a clustering model with  $n$  data points is given by:

$$\frac{1}{n} \sum_{i=1}^n \text{Sample } SC_i$$

Here, sample  $SC$  is the silhouette coefficient for each of the samples. The formula for a sample's silhouette coefficient is,

$$\text{Sample } SC = \frac{b-a}{\max(b,a)}$$

Here,

$a$  = mean distance between a sample and all other points in the same class

$b$  = mean distance between a sample and all other points in the next nearest cluster

The silhouette coefficient is usually bounded between -1 (incorrect clustering) and +1 (excellent quality dense clusters). A higher value of silhouette coefficient generally means that the clustering model is leading to clusters that are dense and well separated and distinguishable from each other. Lower scores indicate overlapping clusters. In `scikit-learn`, we can compute the silhouette coefficient by using the `silhouette_score` function. The function also allows for different options for distance metrics.

```
from sklearn import metrics
```

```
km2_silc = metrics.silhouette_score(X, km2_labels, metric='euclidean')
km5_silc = metrics.silhouette_score(X, km5_labels, metric='euclidean')
```

```
print('Silhouette Coefficient for num clusters=2: ', km2_silc)
print('Silhouette Coefficient for num clusters=5: ', km5_silc)
```

```
Silhouette Coefficient for num clusters=2: 0.697264615606
Silhouette Coefficient for num clusters=5: 0.510229299791
```

Based on the preceding output, we can observe that from the metric results it seems like we have better cluster quality with two clusters as compared to five clusters.

## Calinski-Harabaz Index

The Calinski-Harabaz index is another metric that we can use to evaluate clustering models when the ground truth is not known. The Calinski-Harabaz score is given as the ratio of the between-clusters dispersion mean and the within-cluster dispersion. The mathematical formula for the score for  $k$  clusters is given by,

$$s(k) = \frac{\text{Tr}(B_k)}{\text{Tr}(W_k)} \times \frac{N-k}{k-1}$$

Here,

$$W_k = \sum_{q=1}^k \sum_{x \in c_q} (x - c_q)(x - c_q)^T$$

$$B_k = \sum_q n_q (c_q - c)(c_q - c)^T$$

With  $\text{Tr}$  being the trace of a matrix operator,  $N$  being the number of data points in our data,  $C_q$  being the set of points in cluster  $q$ ,  $c_q$  being the center of cluster  $q$ ,  $c$  being the center of  $E$ , and  $n_q$  being the number of points in cluster  $q$ .

Thankfully we can calculate this index without having to calculate this complex formula by leveraging `scikit-learn`. A higher score normally indicates that the clusters are dense and well separated, which relates to the general principles of clustering models.

```
km2_chi = metrics.calinski_harabaz_score(X, km2_labels)
km5_chi = metrics.calinski_harabaz_score(X, km5_labels)

print('Calinski-Harabaz Index for num clusters=2: ', km2_chi)
print('Calinski-Harabaz Index for num clusters=5: ', km5_chi)

Calinski-Harabaz Index for num clusters=2: 1300.20822689
Calinski-Harabaz Index for num clusters=5: 1621.01105301
```

We can see that both the scores are pretty high with the results for five clusters being even higher. This goes to show that just relying on metric number alone is not sufficient and you must try multiple evaluation methods coupled with feedback from data scientists as well as domain experts.

## Evaluating Regression Models

Regression models are an example of supervised learning methods and owing to the availability of the correct measures (real valued numeric response variables), their evaluation is relatively easier than unsupervised models. Usually in the case of supervised models, we are spoilt for the choice of metrics and the important decision is choosing the right one for our use case. Regression models, like classification models, have a varied set of metrics that can be used for evaluating them. In this section, we go through a small subset of these metrics which are essential.

### Coefficient of Determination or $R^2$

The coefficient of determination measures the proportion of variance in the dependent variable which is explained by the independent variable. A coefficient of determination score of 1 denotes a perfect regression model indicating that all of the variance is explained by the independent variables. It also provides a measure of how well the future samples are likely to be predicted by the model.

The mathematical formula for calculating  $r^2$  is given as follows, where  $\bar{y}$  is the mean of the dependent variable,  $y_i$  indicates the actual true response values, and  $\hat{y}_i$  indicates the model predicted outputs.

$$R^2(y, \hat{y}) = 1 - \frac{\sum_{i=0}^{n_{samples}-1} (y_i - \hat{y}_i)^2}{\sum_{i=0}^{n_{samples}-1} (y_i - \bar{y})^2}$$

In the `scikit-learn` package, this can be calculated by using the `r2_score` function by supplying it the true values and the predicted values (of the output\response variable).

## Mean Squared Error

Mean squared error calculates the average of the squares of the errors or deviation between the actual value and the predicted values, as predicted by a regression model. The mean squared error or MSE can be used to evaluate a regression model, with lower values meaning a better regression models with less errors. Taking the square root of the MSE yields the root-mean-square-error or RMSE, which can also be used as an evaluation metric for regression models.

The mathematical formula for calculating MSE and RMSE is quite simple and is given as follows:

$$MSE(y, \hat{y}) = \frac{1}{n_{samples}} \sum_{i=0}^{n_{samples}-1} (y_i - \hat{y}_i)^2$$

In the `scikit-learn` package the MSE can be calculated by invoking the `mean_squared_error` function from the `metrics` module.

Regression models have many more metrics that can be used for evaluating them, including median absolute error, mean absolute error, explained variance score, and so on. They are easy to calculate using the functions provided by the `scikit-learn` library. Their mathematical formulae are easy to interpret and have an intuitive understanding associated with them. We have only introduced two of them but you are encouraged to explore other sets of metrics that can be used to regression models. We will look at regression models in more detail in the next chapter.

## Model Tuning

In the first two sections of this chapter, you learned how to fit models on our processed data and how to evaluate those models. We will build further upon the concepts introduced till now. In this section, you will learn an important characteristic of all Machine Learning algorithms (which we have been glossing over till now), their importance, and how to find the optimal values for these entities. Model tuning is one of the most important concepts of Machine Learning and it does require some knowledge of the underlying math and logic of the algorithm in focus. Although we cannot deep dive into extensive theoretical aspects of the algorithms that we discuss, we will try to give some intuition about them so that you are empowered to *tune* them better and learn the essential concepts needed for the same.

The models we have developed till now were mostly the default models provided to us by the `scikit-learn` package. By default we mean models with the default configurations and settings if you remember seeing some of the model estimator object parameters. Since the datasets we were analyzing were essentially not tough-to-analyze datasets, even models with default configurations turn up decent solutions. The situation is not that rosy when it comes to actual real-world datasets that have a lot of features, noise, and missing data. You will see in the subsequent chapters how the actual datasets are often tough to process, wrangle, and even harder to model. Hence, it is unlikely that we will always use the default configured models out of the box. Instead we will delve deeper into the models that we are targeting, look at the *knobs* that can be tuned and set to extract the best performance out of any given models. This process of iterative experimentation with dataset, model parameters, and features is the very core of the model tuning process. We start this section by introducing these so-called *parameters* that are associated with ML algorithms, then we try to justify why it is hard to have a perfect model, and in the last section we discuss some strategies that we can pursue to tune our models.

## Introduction to Hyperparameters

What are hyperparameters? The simplest definition is that hyperparameters are *meta parameters* that are associated with any Machine Learning algorithm and are usually set before the model training and building process. We do this because model hyperparameters do not have any dependency on being derived from the underlying dataset on which a model is trained. Hyperparameters are extremely important for tuning the performance of learning algorithms. Hyperparameters are often confused with model parameters, but we must keep in mind that hyperparameters are different than model parameters since they do not have dependency on the data. In simple terms, model hyperparameters represent some high-level concepts or *knobs* that a data scientist can tweak and tune during the model training and building process to improve its performance. Let's take an example to illustrate this in case you still have difficulty in interpreting them.

## Decision Trees

Decision trees are one of the simplest and easy to interpret classification algorithms (also used in regression sometimes; check out CART models). First you will learn how a decision tree is created as hyperparameters are often tightly coupled with the actual intricacies of the algorithm. The decision tree algorithm is based on a greedy recursive partitioning of the initial dataset (features). It leverages a decision tree based structure for taking decisions of how to perform the partitions. The steps involved in learning a decision tree are as follows:

1. Start with whole dataset and find the attribute (feature) that will best differentiate between the classes. This best attribute is found out using metrics such as Information gain or Gini impurity.
2. Once the best attribute is found, separate the dataset in two (or more parts) based on the values of the attributes.
3. If any one part of the dataset contains only labels of one class, we can stop the process for that part and label it as a leaf node of that class.
4. We repeat the whole process until we have leaf nodes in all, of which we have data points of one class only.

The final model returned by the decision tree algorithm can be represented as a flow chart (the core decision tree structure). Consider a sample decision tree for the *Titanic survival prediction* problem depicted in Figure 5-9.

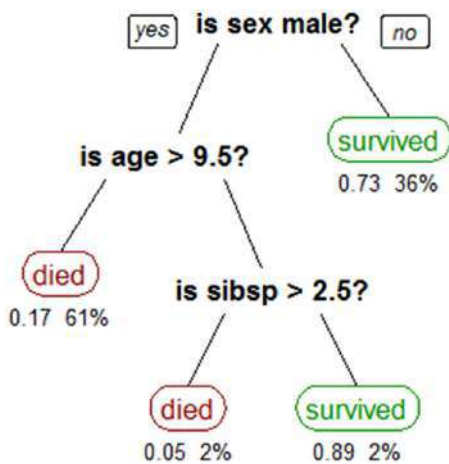

**Figure 5-9.** A sample decision tree model

The decision tree is easy to interpret by following the path with the values of an unknown data point. The leaf node where you end up is the predicted class for the data point. The model parameters in this case are the attributes on which we are splitting (here sex, age, and sibsp) and the values of those attributes. For example if a person was female, it is likely she had survived based on this model. However, infant males having age less than 9 years and 6 months are likely to have perished.

In the algorithm, the decision whether we will continue splitting the dataset at a node further or stop the splitting process is governed by one of the hyperparameters of the algorithm named `min_samples_leaf`. This is a hyperparameter associated with the decision tree algorithm. The default value of this parameter is 1, which means that we can potentially keep splitting the data until we have a leaf node with a single data point (with a unique class label). This leads to a lot of overfitting as potentially each data point can end up in its own leaf node and the model will not learn anything useful. Suppose we want to stop the splitting process if we have 3-4% of the whole dataset in a leaf node and label that node with the majority class of that node. This can be achieved by setting a different value for the specified hyperparameter. This allows us to control the overfitting and help us develop a generalized model. This is just one of the hyperparameters associated with the algorithm; there are many more like the splitting criterion (`criterion`), maximum depth of the tree (`max_depth`), number of features (`max_features`), and so on, which can have different effects on the quality of the overall model.

Similar hyperparameters exist for each learning algorithm. Examples include the learning rate in logistic regression, the kernel in SVMs, and the dropout rate in neural networks. Hyperparameters are generally closely related to the learning algorithm. Hence we require some understanding of the algorithm to have intuition about setting the value of a particular hyperparameter. In the later sections of this chapter and the book, we deal with datasets and models that will require some level of hyperparameter tuning.

## The Bias-Variance Tradeoff

So far, we learned about the necessary concepts which talk about tuning our models. But before go into the process of putting it all together and actually tuning our models, we must understand a potential tradeoff that puts some restriction on the best model that we can develop. This tradeoff is called the *bias versus variance* tradeoff. The obvious question that arises is what are bias and variance in the context of Machine Learning models?

- Bias:** This is the error that arises due to the model (learning algorithm) making wrong assumptions on the parameters in the underlying data. The bias error is the difference between the expected or predicted value of the model estimator and the true or actual value which we are trying to predict. If you remember, model building is an iterative process. If you imagine building a model multiple times over a dataset every time you get some new observations, due to the underlying noise and randomness in the data, predictions will not always be what is expected and bias tries to measure the difference\error in actual and predicted values. It can also be specified as the average approximation error that the models have over all possible training datasets. The last part here, *all possible training datasets*, needs some explanation. The dataset that we observe and develop our models on is one of the possible combinations of data that exist. All the possible combinations of each of the attributes\features that we have in our data will give rise to a different dataset. For example, consider if we have a dataset with 50 binary (categorical) features, then the size of that entire dataset would be  $2^{50}$  data points. The dataset that we model on will obviously be a subset of this huge data. So bias is the average approximation error that we can expect over subset of this entire dataset. Bias is mostly affected by our assumptions (or the model's assumptions) about the underlying data and patterns. For example, consider a simple linear regression model; it makes the assumption that the dependent variable is linearly dependent on the independent variable. Whereas consider the case of a decision tree model it makes no such assumption about the structure of the data and purely learns patterns from the data. Hence, in relative sense, a linear model may tend to have a higher bias than a decision tree model. High bias makes a model miss relevant relationships between features and the output variables in data.
- Variance:** This error arises due to model sensitivity to fluctuations in the dataset that can arise due to new data points, features, randomness, noise, and so on. It is the variance of our approximation function over all possible datasets. It represents the sensitivity of the model prediction results on particular set of data points. Suppose you could have learned the model on different subset of all possible datasets then variance would quantify how the results of the model change with the change in the dataset. If the results stay quite stable then the model would be said to having a low variance but if the results vary considerably each time then the model would said to be having a high variance. Consider the same example of contrasting a linear model against a decision tree model, under the assumption that a clear linear relationship exists between the dependent and the independent data variables. Then for a sufficiently large dataset our linear model will always capture that relationship. Whereas the capability of a decision tree model depends on the dataset, if we get a dataset which consists of a lot of outliers, we are likely to get a bad decision tree model. Hence we can make a statement that the decision tree model will be having a higher variance than a linear regression model based on data and the underlying noise\randomness. High variance makes a model too sensitive to outliers or random noise instead of generalizing well.

An effective way to get a clearer idea at this somewhat confusing concept is through a visual representation of bias and variance, as depicted in Figure 5-10.

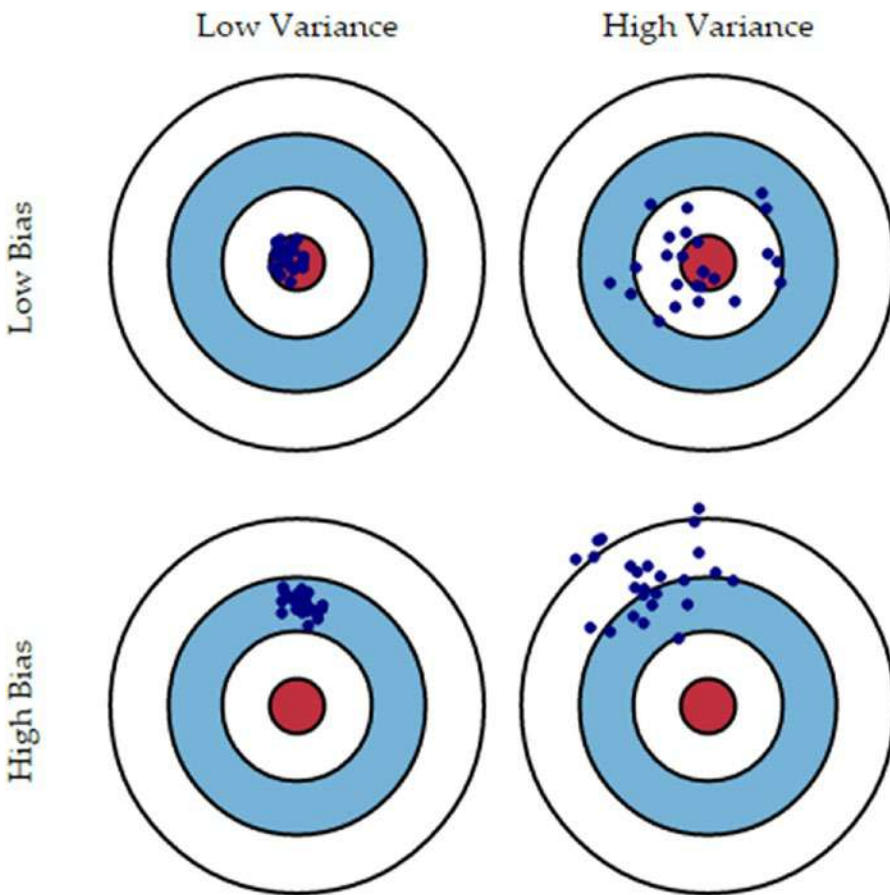

**Figure 5-10.** *The Bias-variance tradeoff*

In Figure 5-10, the inner red circle represents the perfect model that we can have considering all the combinations of the data that we can get. Each blue dot (·) marks a model that we have learned on the basis of combinations of the dataset and features that we get.

- Models with low bias, low variance, represented by the top left image, will learn a good general structure of underlying data patterns and relationships that will be close to the hypothetical model and predictions will be consistent and hit the bull's eye!
- Models with low bias, high variance, represented by the top right image, are models that generalize to some extent (learn proper relationships\patterns) and perform decently on average due to low bias but are sensitive to the data it is trained on leading to high variance and hence predictions keep fluctuating.
- Models with high bias, low variance will tend to make consistent predictions irrespective of datasets on which the models are built leading to low variance but due to high bias, it will not learn the necessary patterns\relationships in the data that are required for correct predictions and hence misses the mark due to the high bias error on average, as depicted in the bottom-left image.



- Models with high bias, high variance are the worst sort of models possible, as they will not learn necessary data attribute relationships that are essential to correlation with output responses. Also they will be extremely sensitive to data and outliers and noise leading to highly fluctuating predictions which result in high variance, as depicted in the bottom-right image.

## Extreme Cases of Bias-Variance

In real-world modeling, we will always have a tradeoff between decreasing bias and variance simultaneously. To understand why we have this tradeoff, we must first consider the two possible extreme cases of bias and variance.

### Underfitting

Consider a linear model that is lazy and always predicts a constant value. This model will have extremely low variance (in fact it will be a zero variance model) as the model is not dependent at all on which subset of data it gets. It will always predict a constant and hence have stable performance. But on the other hand it will have extremely high bias as it has not learned anything from the data and made a very rigid and erroneous assumption about the data. This is the case of model underfitting, in which we fail to learn anything about the data, its underlying patterns, and relationships.

### Overfitting

Consider the opposite case in which we have model that attempts to fit every data point it encounters (the closest example would be fitting an  $n^{\text{th}}$  order polynomial curve for an  $n$ -observation dataset so that the curve passes through each point). In this case, we will get a model which will have low bias as no assumption to structure of data was made (even when there was some structure) but the variance will be very high as we have tightly fit the model to one of the possible subsets of data (focusing too much on the training data). Any subset different from the training set will lead to a lot of error. This is the case of overfitting, where we have built our model so specific to the data at hand that it fails to do any generalization over other subsets of data.

## The Tradeoff

The total generalization error of any model will be a sum of its bias error, variance error, and irreducible error, as depicted in the following equation.

$$\text{Generalization Error} = \text{Bias Error} + \text{Variance Error} + \text{Irreducible Error}$$

Such that the irreducible error is the error that gets introduced due to noise in the training data itself, something that is common in real-world datasets and not much can be done about it. The idea is to focus on the other two errors. Every model needs to do a tradeoff between the two choices: making assumptions about the structure of data or fitting itself too closely to the data at hand. Either choice in entirety will lead to one of the extreme cases. The idea is to focus on balancing model complexity by doing an optimal tradeoff between bias and variance, as depicted in Figure 5-11.

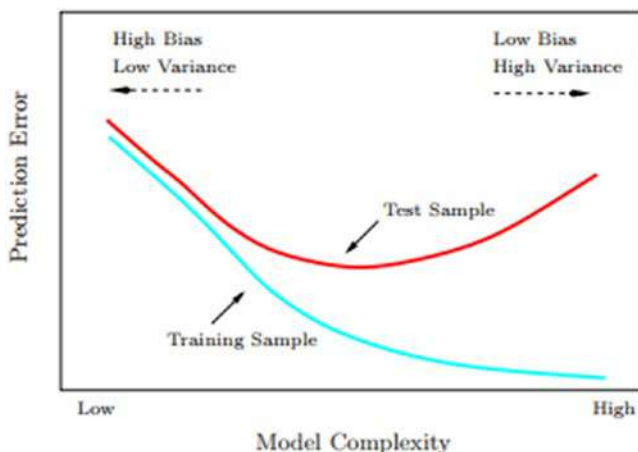

**Figure 5-11.** Test and train errors as a function of model complexity (Source: *The Elements of Statistical Learning*, Tibshirani et al. Springer)

Figure 5-11 should give you more clarity on the tradeoff that needs to be done to prevent an increase in model errors. We will need to make some assumptions about the underlying structure in the data but they must be reasonable. At the same time, the model must ensure that it learns from the data at hand and generalizes well instead of overfitting to each and every data point. This tradeoff can be controlled by making sure that our model is not a very complex model and by ensuring reasonable performance on the unseen validation data. We will cover more on cross validation in the next section. We recommend you to check out the section on model selection and the book *Bias-Variance Tradeoff in the Elements of Statistical Learning*, Tibshirani et al., Springer.

## Cross Validation

In the initial sections of this chapter when we were learning to fit different models, we followed the practice of partitioning the data into a training set and a test set. We built the model on the training set and reported its performance on the test set. Although that way of building models works, when working on tuning models intensively, we need to consider some other strategies around validation datasets. In this section we will discuss how we can use the same data to build different models and also tune their hyperparameters using a simple data partitioning strategy. This strategy is one of the most prevalent practices in Data Science domain irrespective of the type of models and it is called cross validation or just CV. This is extremely useful when you also have less data observations and cannot segregate a specific partition of data for being a validation set (more on this shortly!). You can then leverage a cross-validation strategy to leverage parts of the training data itself for validation in such a way that you don't end up overfitting the model.

The main intention of any model building activity is to develop a generalized model on the *available* data which will perform well on the *unseen* data. But to estimate a model's performance on unseen data, we need to simulate that unseen data using the data that we have available. This is achieved by splitting our available data into training and testing sets. By following this simple principle we ensure that we don't evaluate the model on the data that it has already seen and been trained on. The story would be over here if we were completely satisfied with the model that we developed. But the initial models are seldom satisfactory enough for deployment.

In theory, we can extend the same principles for tuning our algorithm. We can evaluate the performance of particular values of the model hyperparameters on the test set. Retrain the model with a different partition of training and test set with a different values of hyperparameters. If the new parameters perform better than the old ones we take them and keep repeating the same process until we have the optimal values of the hyperparameters. This scheme of things is simple but it suffers from a serious flaw. It induces a bias in the model development process. Although the test set is changed in every iteration, the data is being *seen* by the model to make some choices about the model development process (as we tune and build the model). Hence, the models that we develop end up being biased and not well-generalized and their performance may or may not reflect their performance on unseen data.

A simple change in the data splitting process can help us avoid this leakage of unseen data. Suppose we initially made three different subsets of data instead of the original two. One is the usual training set, the second one is the test set and the last one is called a validation set. So we can train our models on the train data evaluate their performance on the validation data to tune model parameters (or even to select among different models). Once we are done with the tuning process, we can evaluate the final model on the really *unseen* test set and report the performance on the test set as the approximate performance of the model on the real-world unseen data. In the very essence of things this is the basic principle behind the process of cross validation, as depicted in Figure 5-12.

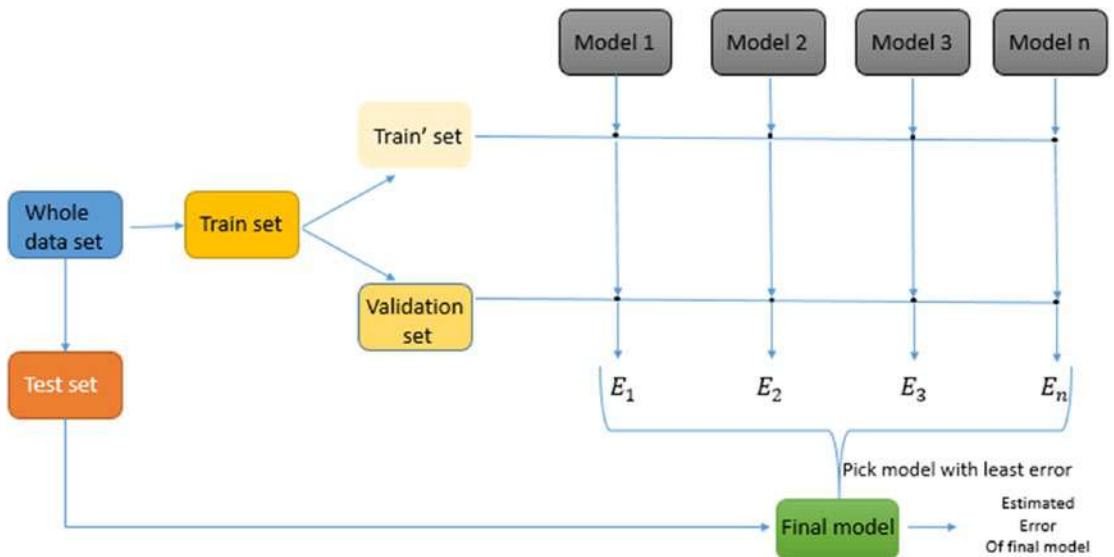
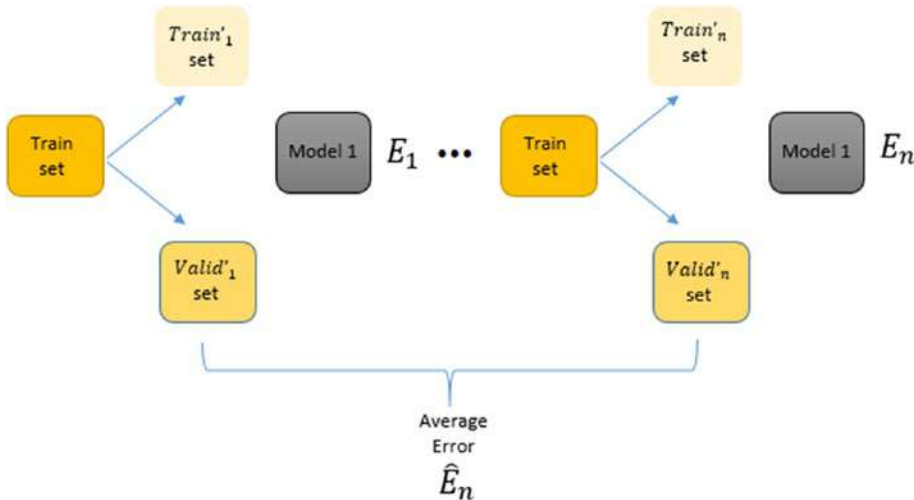

**Figure 5-12.** Building toward the cross-validation process for model building and tuning

Figure 5-12 gives us an idea of how the whole process works. We divide the original dataset into a train and test set. The test set is completely set aside from the learning process. The train set so obtained is again split into an actual train set and a validation set. Then we learn different models on the train set. A point worth noting here is that the models are general, i.e. all of them can be of single type for example logistic regression but with different hyperparameters. They can also be models using other algorithms like tree based methods, support vector machines, and so on. The process of model selection is similar irrespective of whether we are assessing completely different models or whether we are trying out different hyperparameter values of the same type of models. Once we have the models developed, we assess their performance on the validation set and select the model with the best performance as the final model. We leverage model evaluation metrics for this based on the type of model (*accuracy*, *f1 Score*, *rmse*, *silhouette coefficient*, and so on).

The previously described process seems to be good. We have described the *validation* part of the process but we haven't touched on the *cross* part of it. So where is the *cross-validation*? To understand that intricacy of the CV process, we would have to discuss why we need this in the first place. The need for it arises from the fact that by dividing the data into test and a validation set we have lost out on a decent amount of data which we could have used to further refine our modeling process. Also another important point is that if we take a model's error for a single iteration to be its overall error we are making a serious mistake. Instead we want to take some average measure of error by building multiple iterations of the same model. But if we keep rebuilding the model on the same dataset, we are not going to get much difference in the model performance. We address these two issues by introducing the cross concept of cross-validation.

The idea of cross validation is to get different splits of train and validation sets (different observations in each set, each time) using some strategy (which we will elaborate on later) and then build multiple iterations of each model on these different splits. The average error on these splits is then reported as the error of the model in question and the final decision is made on this averaged error metric. This strategy has a brilliant effect on the estimated error of each model, as it ensures that the averaged error is a close approximation of the model's error on really unseen data (here our test set) and we could also leverage the complete training dataset for building the model. This process is explained pictorially in Figure 5-13.



**Figure 5-13.** The final cross-validation process for model building and tuning

The various strategies in which these different train and validation sets can be generated gives rise to different kind of cross-validation strategies. The common idea in each of these strategies remains the same. The only difference is in the way the original train set is split into a train and validation set for each iteration of model building.

## Cross-Validation Strategies

We explained the basic principle of cross validation in the previous section. In this section, we see the different strategies in which we can split the training data into training and validation data. Apart from the way of this split, as mentioned before, the process for each of these strategies remains the same. The major types of cross-validation strategies are described as follows.

## Leave One Out CV

In this strategy for cross validation, we select a random single data point from the initial training dataset and that becomes our validation set. So we have a single point only in our validation set and the rest  $n-1$  observations become our training set. This means that if we have 1000 data points in a training set then we will be developing 1000 iterations of each model with a different training set and validation set each time such that the validation set has one observation and the rest (999) go into the training set. This may become infeasible if the dataset size is large. But in practice the error can be estimated by performing some small number of iterations. Due to the computational complexity of this measure, it is mostly suitable for small datasets and rarely used in practice.

## K-Fold CV

The other strategy for cross-validation is to split the training dataset into  $k$  equal subsets. Out of these  $k$  subsets we train the model on  $k-1$  subsets and keep one subset as a validation set. This process is repeated  $k$  times and the error is averaged over the  $k$  models that are obtained by developing different iterations of the model. We keep changing the validation set in each of these iterations which ensures that in each iteration, the model is trained on a different subset of data. This practice of cross-validation is quite effective in practice, both for model selection and hyperparameter optimization.

A natural question for this strategy is to select the appropriate number of *folds*, as they will both control our error approximation and the computational runtime of our CV process. There are mathematical ways to select the most appropriate  $k$  but in practice a good choice of  $k$  ranges from 5-10. So, in most cases, we can do a 5-fold or 10-fold validation and be confident of the results that we obtained.

## Hyperparameter Tuning Strategies

Based on our discussions until now, we have all the prerequisites for tuning our model. We know what hyperparameters are, how the performance of a model can be evaluated, and how we can use cross-validation to search through the parameter space for optimal value of our algorithm's hyperparameters. In this section, we discuss two major strategies that tie all this together to determine the most optimal hyperparameters. Fortunately, the `scikit-learn` library has an excellent built-in support for performing hyperparameter search with cross-validation.

There are two major ways in which we can search our parameter space for an optimal model. These two methods differ in the way we will search for them: systemic versus random. In this section we will discuss these two methods along with hands-on examples. The takeaway from this section is to understand the processes so that you can start leveraging on your own datasets. Also note that even if we don't mention it explicitly, we will always be using cross validation to perform any of these searches.

## Grid Search

This is the simplest of the hyperparameter optimization methods. In this method we will specify the grid of values (of hyperparameters) that we want to try out and optimize to get the best parameter combinations. Then we will build models on each of those values (combination of multiple parameter values), using cross-validation of course, and report the best parameters' combination in the whole grid. The output will be the model using the best combination from the grid. Although it is quite simple, it suffers from one serious drawback that the user has to manually supply the actual parameters, which may or may not contain the most optimal parameters.

In `scikit-learn`, grid search can be done using the `GridSearchCV` class. We go through an example by performing grid search on a support vector machine (SVM) model on the breast cancer dataset from earlier. The SVM model is another example of a supervised Machine Learning algorithm that can be used for classification. It is an example of a maximum margin classifier, where it tries to learn a representation of all the data points such that separate categories\labels are divided or separated by a clear gap, which is as large as possible. We won't be going into further extensive details here since the intent is to run grid search, but we recommend you to check out some standard literature on SVMs if you are interested.

Let's first split our breast cancer dataset variables `X` and `y` into `train` and `test` datasets and build an SVM model with default parameters. Then we'll evaluate its performance on the test dataset by leveraging our `model_evaluation_utils` module.

```
from sklearn.model_selection import train_test_split
from sklearn.svm import SVC

# prepare datasets
X_train, X_test, y_train, y_test = train_test_split(X, y, test_size=0.3, random_state=42)

# build default SVM model
def_svc = SVC(random_state=42)
def_svc.fit(X_train, y_train)

# predict and evaluate performance
def_y_pred = def_svc.predict(X_test)
print('Default Model Stats:')
meu.display_model_performance_metrics(true_labels=y_test, predicted_labels=def_y_pred,
                                     classes=[0,1])
```

Model Performance metrics:	Model Classification report:					Prediction Confusion Matrix:		
Accuracy: 0.6316								
Precision: 0.3989								
Recall: 0.6316								
F1 Score: 0.489								
		precision	recall	f1-score	support	Predicted:		
	0	0.00	0.00	0.00	63	Actual: 0	0	1
	1	0.63	1.00	0.77	108	1	0	108
	avg / total	0.40	0.63	0.49	171			

**Figure 5-14.** Model performance metrics for default SVM model on the breast cancer dataset

Would you look at that, our model gives an overall F1 Score of only 49% and model accuracy of 63% as depicted in Figure 5-14. Also by looking at the confusion matrix, you can clearly see that it is predicting every data point as benign (label 1). Basically our model learned nothing! Let's try tuning this model to see if we get something better. Since we have chosen a SVM model, we specify some hyperparameters specific to it, which includes the parameter `C` (deals with the margin parameter in SVM), the kernel function (used for transforming data into a higher dimensional feature space) and `gamma` (determines the influence a single training data point has). There are a lot of other hyperparameters to tune, which you can check out at <http://scikit-learn.org/stable/modules/generated/sklearn.svm.SVC.html> for further details. We build a grid by supplying some pre-set values. The next choice is selecting the score or metric we want to maximize here we have chosen to maximize accuracy of the model. Once that is done, we will be using five-fold cross-validation to build multiple models over this grid and evaluate them to get the best model. Detailed code and outputs are depicted as follows.

```
from sklearn.model_selection import GridSearchCV

# setting the parameter grid
```

```

grid_parameters = {'kernel': ['linear', 'rbf'],
                  'gamma': [1e-3, 1e-4],
                  'C': [1, 10, 50, 100]}

# perform hyperparameter tuning
print("# Tuning hyper-parameters for accuracy\n")
clf = GridSearchCV(SVC(random_state=42), grid_parameters, cv=5, scoring='accuracy')
clf.fit(X_train, y_train)
# view accuracy scores for all the models
print("Grid scores for all the models based on CV:\n")
means = clf.cv_results_['mean_test_score']
stds = clf.cv_results_['std_test_score']
for mean, std, params in zip(means, stds, clf.cv_results_['params']):
    print("%0.5f (+/-%0.05f) for %r" % (mean, std * 2, params))
# check out best model performance
print("\nBest parameters set found on development set:", clf.best_params_)
print("Best model validation accuracy:", clf.best_score_)

# Tuning hyper-parameters for accuracy

```

Grid scores for all the models based on CV:

```

0.95226 (+/-0.06310) for {'C': 1, 'gamma': 0.001, 'kernel': 'linear'}
0.91206 (+/-0.04540) for {'C': 1, 'gamma': 0.001, 'kernel': 'rbf'}
0.95226 (+/-0.06310) for {'C': 1, 'gamma': 0.0001, 'kernel': 'linear'}
0.92462 (+/-0.02338) for {'C': 1, 'gamma': 0.0001, 'kernel': 'rbf'}
0.96231 (+/-0.04297) for {'C': 10, 'gamma': 0.001, 'kernel': 'linear'}
0.90201 (+/-0.04734) for {'C': 10, 'gamma': 0.001, 'kernel': 'rbf'}
0.96231 (+/-0.04297) for {'C': 10, 'gamma': 0.0001, 'kernel': 'linear'}
0.92965 (+/-0.03425) for {'C': 10, 'gamma': 0.0001, 'kernel': 'rbf'}
0.95729 (+/-0.05989) for {'C': 50, 'gamma': 0.001, 'kernel': 'linear'}
0.90201 (+/-0.04734) for {'C': 50, 'gamma': 0.001, 'kernel': 'rbf'}
0.95729 (+/-0.05989) for {'C': 50, 'gamma': 0.0001, 'kernel': 'linear'}
0.93467 (+/-0.02975) for {'C': 50, 'gamma': 0.0001, 'kernel': 'rbf'}
0.95477 (+/-0.05772) for {'C': 100, 'gamma': 0.001, 'kernel': 'linear'}
0.90201 (+/-0.04734) for {'C': 100, 'gamma': 0.001, 'kernel': 'rbf'}
0.95477 (+/-0.05772) for {'C': 100, 'gamma': 0.0001, 'kernel': 'linear'}
0.93216 (+/-0.04674) for {'C': 100, 'gamma': 0.0001, 'kernel': 'rbf'}

```

```

Best parameters set found on development set: {'C': 10, 'gamma': 0.001, 'kernel': 'linear'}
Best model validation accuracy: 0.962311557789

```

Thus, from the preceding output and code, you can see how the best model parameters were obtained based on cross-validation accuracy and we get a pretty awesome validation accuracy of 96%. Let's take this optimized and tuned model and put it to the test on our test data!

```

gs_best = clf.best_estimator_
tuned_y_pred = gs_best.predict(X_test)

print('\n\nTuned Model Stats:')
meu.display_model_performance_metrics(true_labels=y_test, predicted_labels=tuned_y_pred,
                                     classes=[0,1])

```

Model Performance metrics:	Model Classification report:				Prediction Confusion Matrix:		
Accuracy: 0.9708		precision	recall	f1-score	support	Predicted:	
Precision: 0.9709						0	1
Recall: 0.9708	0	0.95	0.97	0.96	63	Actual: 0	61
F1 Score: 0.9708	1	0.98	0.97	0.98	108	1	3
	avg / total	0.97	0.97	0.97	171		105

**Figure 5-15.** Model performance metrics for tuned SVM model on the breast cancer dataset

Well things are certainly looking great now! Our model gives an overall F1 Score and model accuracy of 97% on the test dataset too, as depicted in Figure 5-14. This should give you a clear indication of the power of hyperparameter tuning! This scheme of things can be extended for different models and their respective hyperparameters. We can also play around with the evaluation measure we want to optimize. The scikit-learn framework provides us with different values that we can optimize. Some of them are `adjusted_rand_score`, `average_precision`, `f1`, `average_recall`, and so on.

## Randomized Search

Grid search is a very popular method to optimizing hyperparameters in practice. It is due to its simplicity and the fact that it is embarrassingly parallelizable. This becomes important when the dataset we are dealing with is of a large size. But it suffers from some major shortcomings, the most important one being the limitation of manually specifying the grid. This brings a human element into a process that could benefit from a purely automatic mechanism.

Randomized parameter search is a modification to the traditional grid search. It takes input for grid elements as in normal grid search but it can also take distributions as input. For example consider the parameter `gamma` whose values we supplied explicitly in the last section instead we can supply a distribution from which to sample `gamma`. The efficacy of randomized parameter search is based on the proven (empirically and mathematically) result that the hyperparameter optimization functions normally have low dimensionality and the effect of certain parameters are more than others. We control the number of times we want to do the random parameter sampling by specifying the number of iterations we want to run (`n_iter`). Normally a higher number of iterations mean a more granular parameter search but higher computation time.

To illustrate the use of randomized parameter search, we will use the example we used earlier but replace the `gamma` and `C` values with a distribution. The results in our example may not be very different from the grid search, but we establish the process that can be followed for future reference.

```
import scipy
from sklearn.model_selection import RandomizedSearchCV

param_grid = {'C': scipy.stats.expon(scale=10),
              'gamma': scipy.stats.expon(scale=.1),
              'kernel': ['rbf', 'linear']}
random_search = RandomizedSearchCV(SVC(random_state=42), param_distributions=param_grid,
                                   n_iter=50, cv=5)
random_search.fit(X_train, y_train)
print("Best parameters set found on development set:")
random_search.best_params_
```

Best parameters set found on development set:

Out[183]:

```
{'C': 12.020578954763398, 'gamma': 0.036384519279056469, 'kernel': 'linear'}
```



```
# get best model, predict and evaluate performance
rs_best = random_search.best_estimator_
rs_y_pred = rs_best.predict(X_test)
meu.get_metrics(true_labels=y_test, predicted_labels=rs_y_pred)
```

```
Accuracy: 0.9649
Precision: 0.9649
Recall: 0.9649
F1 Score: 0.9649
```

In this example, we are getting the values of parameter C and gamma from an exponential distribution and we are controlling the number of iterations of model search by the parameter `n_iter`. While the overall model performance is similar to grid search, the intent is to be aware of the different strategies in model tuning.

## Model Interpretation

The objective of Data Science or Machine Learning is to solve real-world problems, automate complex tasks, and make our life easier and better. While data scientists spend a huge amount of time building, tuning, and deploying models, one must ask the questions, “What is this going to be used for?” and “How does this really work?” and the most important question, “Why should I trust your model?”. A business or organization will be more concerned about business objective, generating profits, and minimizing losses by leveraging analytics and Machine Learning. Hence often there is a disconnect between analytics teams and key stakeholders, customers, clients, or management in trying to explain how models really work. Most of the time, explaining complex theoretical and mathematical concepts can be really difficult to non-experts who may not have an idea or, worse, might not be interested in knowing all the gory details. This brings us back to the main objective, “can we explain and interpret Machine Learning models in an easy to understand way”, such that anyone even without thorough knowledge of Machine Learning can understand them. The benefit of this would be two-fold—Machine Learning models will not just stop at being research projects or proof-of-concepts and it will pave the way for higher adoption of Machine Learning based solutions in enterprises.

Some Machine Learning models use interpretable algorithms, for example a decision tree will give you the importance of all the variables as an output. Also the prediction path of any new data point can be analyzed using a decision tree hence we can learn what variable played a crucial role for a prediction. Unfortunately, this can’t be said for a lot of models, especially for the ones who have no notion of variable importance.

Some Machine Learning Models are interpretable in nature by default - e.g. generative model such as Bayesian Rule List, Letham et. al (<https://arxiv.org/abs/1511.01644>), while other simple black box models such as Simple Decision Trees could be made interpretable by using the feature importance as an output. Also, the prediction path for a single tree from the root of the tree to its leaves can be visualized capturing the contribution of the feature to the estimators decision policies. But, this intuitiveness may not be possible for complex non-linear models - Random Forest, Deep Neural Networks - Convolutional Neural Networks (CNNs), Recurrent Neural Networks (RNNS). The lack of understanding of the complex nature of Machine Learned decision policies makes predictive models to be still viewed as black boxes. Model interpretations can help a data scientist and an end user in a variety of ways. It will help bridge the gap that often exists between the technology teams and the business. For example, it can help identify the reason why a particular prediction is being made and it can be verified using the domain knowledge of the end user by leveraging that easy to understand interpretation. It can also help the data scientists understand the interactions among features that can lead to better feature engineering and enhanced performance. It can also help in model comparisons and explaining the results better to the business stakeholders.

While the simplest approach to having models that are interpretable is to use algorithms that lead to interpretable models like decision trees, logistic regression and others. But we don't have the guarantee that an interpretable model will provide us with the best performance. Hence we cannot always resort to such models. A recent, much better approach is to explain model predictions in an easy-to-interpret manner by learning an interpretable model locally around the prediction. This topic in fact has gained extensive attention very recently in 2016. Refer to the original research paper by M.T. Ribeiro, S. Singh & C. Guestrin titled "*Why Should I Trust You?: Explaining the Predictions of Any Classifier*" from <https://arxiv.org/pdf/1602.04938.pdf> to understand more about model interpretation and the LIME framework, which proposes to solve this. The LIME framework attempts to successfully explain any black box model locally (somewhere we need define the scope of Interpretation - Globally and Locally) and you can check out the GitHub repository at <https://github.com/marcotcr/lime>.

We will be leveraging another library named Skater, an open sourced Python library designed to demystify the inner workings of predictive models. Skater defines the scope of interpreting models 1. Globally (on the basis of a complete dataset) and 2. Locally (on the basis of an individual prediction). For global explanations, Skater makes use of model-agnostic variable importance and partial dependence plots to judge the bias of a model and understand its general behavior. To validate a model's decision policies for a single prediction, on the other hand, the library currently embraces a novel technique called local interpretable model agnostic explanation (LIME, Ribeiro et al., 2016), which uses local surrogate models to assess performance. The library is authored by Aaron Kramer, Primit Choudhary, and the DataScience.com team, Skater is now a mainstream project and an excellent framework for model interpretation. We would like to acknowledge and thank the folks at DataScience.com—Ian Swanson, Primit Choudhary, and Aaron Kramer—for developing this amazing framework and especially Primit for taking out time to explain to us in detail the features and vision for the Skater project. Some advantages of leveraging Skater are mentioned as follows and some of them are still actively being worked on and improved.

- Production ready code using functional style programming (declarative programming paradigm)
- Enable Interpretation for both classification and regression based models for Supervised Learning problems to start with and then gradually extend it to support interpretation for Unsupervised Learning problems as well. This includes computationally efficient Partial Dependence Plots and model independent feature importance plots.
- Workflow abstraction: Common interface to perform local interpretation for In-Memory (Model is under development) as well as Deployed Model (Model has been deployed in production)
- Extending LIME - added support for interpreting Regression based model, better sampling distribution for generating samples around a local prediction, researching the ability to include non-linear models for local evaluation
- Enabling support of Rule Based interpretable Models - e.g. Letham et. al (<https://arxiv.org/abs/1511.01644>)
- Better support for model Evaluation for NLP based models - e.g. Bach et. al Layerwise Relevance Propagation (<http://journals.plos.org/plosone/article?id=10.1371/journal.pone.0130140>)
- Better support for Image Interpretability - Batra et. al. Gradient weighted Class Activation Map (<https://arxiv.org/abs/1610.02391>)

Besides this, since the time this project started, they have committed some improvements, namely support for regression back into the original LIME repository and they still have other aspects of interpretation in their roadmap and further improvements to LIME in the future. You can easily install skater by running the `pip install -U Skater` command from your prompt or terminal. For more information, you can check out the GitHub repository at <https://github.com/datascienceinc/Skater> or join the chat group here: <https://gitter.im/datascienceinc-skater/Lobby>.

## Understanding Skater

Skater is an open source Python framework that aims to provide model agnostic interpretation of predictive models. It is an active project on GitHub at <https://github.com/datascienceinc/Skater> with many of the previously mentioned features being worked upon actively. The idea of skater is to understand black box Machine Learning models by querying them and interpreting their learned decision policies. The philosophy of skater is that all models should be evaluated as black boxes and decision criteria of the models are inferred and interpreted based on input perturbations and observing the corresponding output predictions. The scope of model interpretation by leveraging skater, enables us to do both global and local interpretation as depicted in Figure 5-16.

### Global Interpretation

Being able to explain the conditional interaction between dependent (*response*) variables and independent (*predictor, or explanatory*) variables based on the complete dataset

### Local Interpretation

Being able to explain the conditional interaction between dependent (*response*) variables and independent (*predictor, or explanatory*) variables wrt to a single prediction

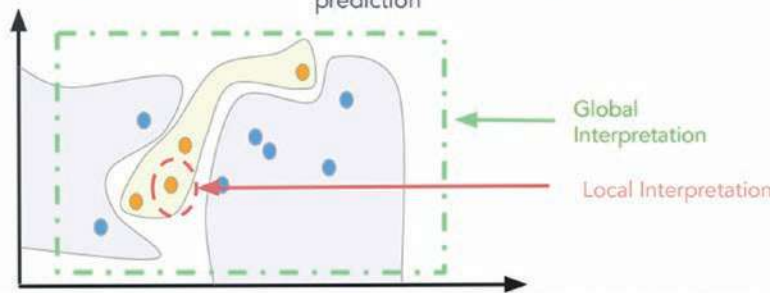

**Figure 5-16.** *Scope of Model Interpretation (source: DataScience.com)*

Using the skater library, we can explore the features' importance, partial dependency plots upon features, and global and local fidelity of the predictions made by the model. The fidelity of a model can be described as the reasons on the basis of which the model calculated and predicted a particular class. For example, suppose we have a model that predicts whether a particular user transaction can be tagged as a fraudulent transaction or not. The output of the model will be much more trustworthy if we can identify, interpret, and depict that the reason the model marked the prediction as fraud, is because the amount is larger than the maximum transaction of the user in the last six months and the location of transaction is 1000 kms away from user's normal transaction areas. Contrast it with the case where we are only given a prediction label without any justifying explanation.

The general workflow within the skater package is to create an interpretation object, create a model object, and run interpretation algorithms. Also, an Interpretation object takes as input, a dataset, and optionally some metadata like feature names and row identifiers. Internally, the Interpretation object will generate a DataManager to handle data requests and sampling. While we can interpret any model by leveraging the model estimator objects, for ensuring consistency and proper functionality across all of skater's interfaces, model objects need to be wrapped in skater's Model object, which can either be an InMemoryModel object over an actual model or even a DeployedModel object to take a model behind an API or web service. Figure 5-17 depicts a standard machine learning workflow and how skater can be leveraged for interpreting the two different types of models we just mentioned. Let's use our logistic regression model from earlier to do some model interpretation on our breast cancer dataset!

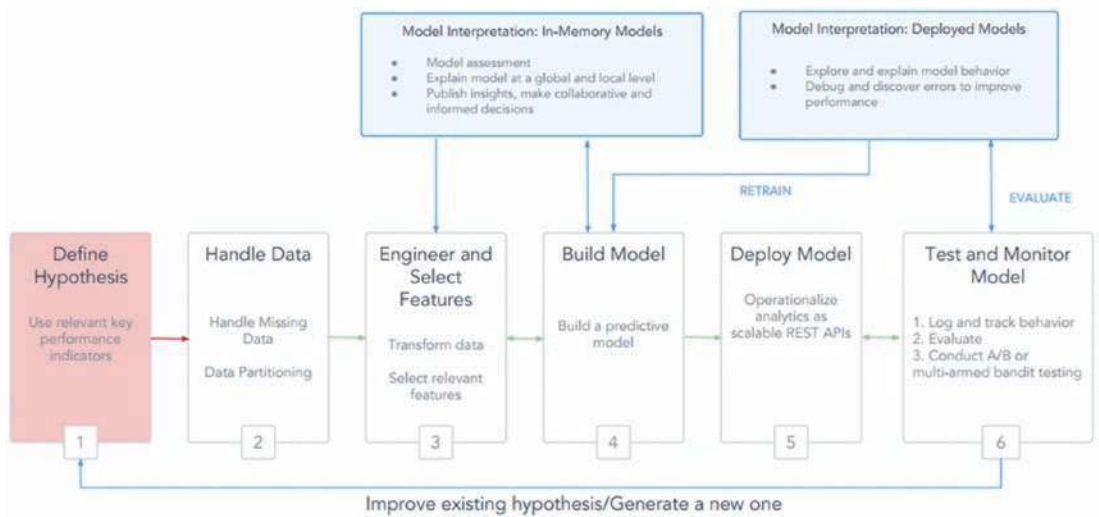

Figure 5-17. Model Interpretation in a standard Machine Learning Workflow (source: DataScience.com)

## Model Interpretation in Action

We will be using our train and test datasets from the breast cancer dataset that we have been using in this chapter for consistency. We will leverage the X\_train and X\_test variables and also the logistic model object (logistic regression model) that we created previously. We will try to run some model interpretations on this model object. The standard workflow for model interpretation is to create a skater interpretation and model object.

```
from skater.core.explanations import Interpretation
from skater.model import InMemoryModel

interpreter = Interpretation(X_test, feature_names=data.feature_names)
model = InMemoryModel(logistic.predict_proba, examples=X_train, target_names=logistic.classes_)
```

Once this is complete, we are ready to run model interpretation algorithms. We will start by trying to generate feature importances. This will give us an idea of the degree to which our predictive model relies on particular features. The skater framework's feature importance implementation is based on an information theory criterion, where it measures the entropy in the change of predictions, given a perturbation of a specific feature. The idea is that the more a model's decision making criteria depends on a feature, the more the predictions will change as a function of perturbing the feature.

```
plots = interpreter.feature_importance.plot_feature_importance(model, ascending=False)
```

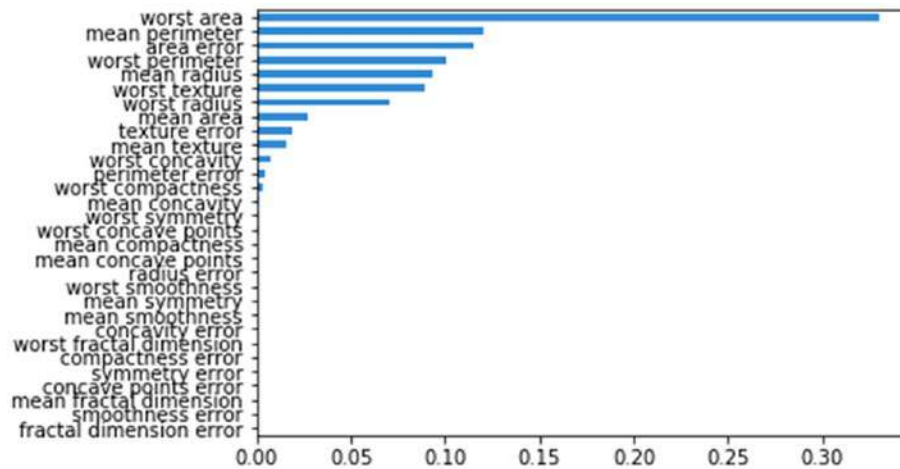

**Figure 5-18.** Feature importances obtained from our logistic regression model

We can clearly observe from Figure 5-18 that the most important feature in our model is `worst area`, followed by `mean perimeter` and `area error`. Let's now consider the most important feature, `worst area`, and think about ways it might influence the model decision making process during predictions. Partial dependence plots are an excellent tool to leverage to visualize this. In general, partial dependence plots help describe the marginal impact of a specific feature on model prediction by holding the other features in the model constant. The derivative of partial dependence, describes the impact of a feature. The following code helps build the partial dependence plot for the `worst area` feature in our model.

```
p = interpreter.partial_dependence.plot_partial_dependence(['worst area'], model,
                                                           grid_resolution=50,
                                                           with_variance=True, figsize = (6, 4))
```

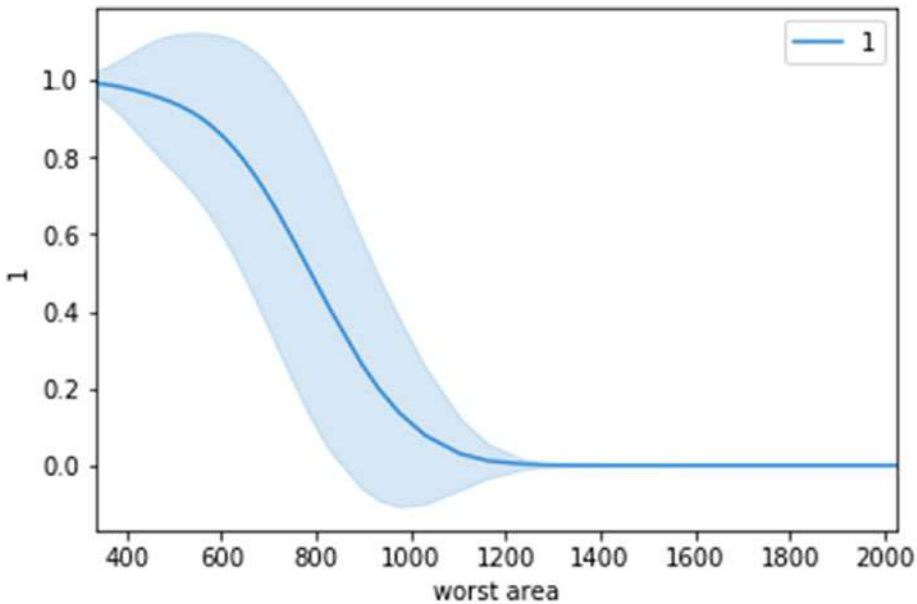
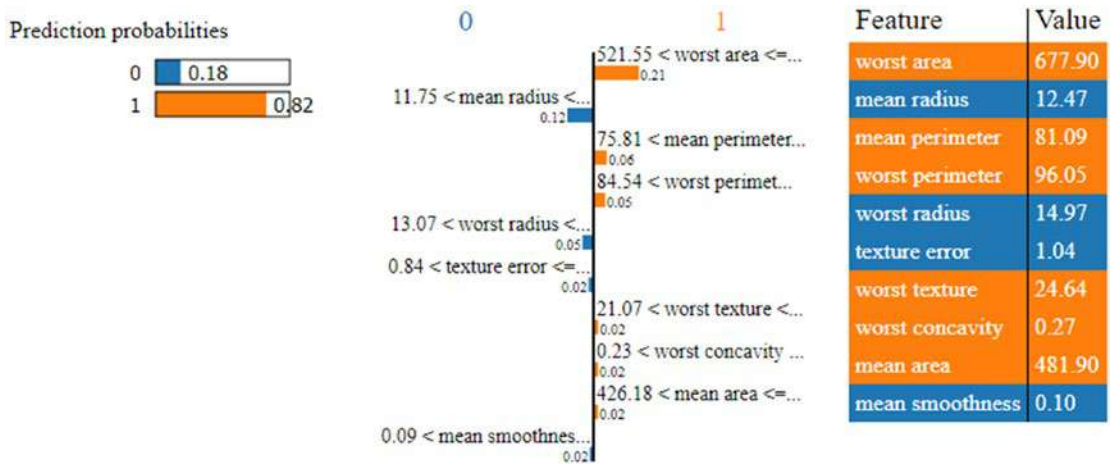

**Figure 5-19.** One-way partial dependence plot for our logistic regression model predictor based on worst area

From the plot in Figure 5-19, we can see that the `worst_area` feature has a strong influence on the model decision making process. Based on the plot, if the `worst_area` value decreases from 800, the model is more prone to classify the data point as benign (label 1) which indicates no cancer. This is definitely interesting! Let's try to interpret some actual predictions now. We will predict two data points, one not having cancer (label 1) and one having cancer (label 0), and try to interpret the prediction making process.

```
from skater.core.local_interpretation.lime.lime_tabular import LimeTabularExplainer
exp = LimeTabularExplainer(X_train, feature_names=data.feature_names,
                           discretize_continuous=True, class_names=['0', '1'])

# explain prediction for data point having no cancer, i.e. label 1
exp.explain_instance(X_test[0], logistic.predict_proba).show_in_notebook()
```



**Figure 5-20.** Model interpretation for our logistic regression model's prediction for a data point having no cancer (benign)

The results depicted in Figure 5-20 show the features that were primarily responsible for the model to predict the data point as label 1, i.e. having no cancer. We can also see the feature that was the most influential in this decision was `worst area`! Let's run a similar interpretation on a data point with malignant cancer.

```
# explain prediction for data point having malignant cancer, i.e. label 0
exp.explain_instance(X_test[1], logistic.predict_proba).show_in_notebook()
```

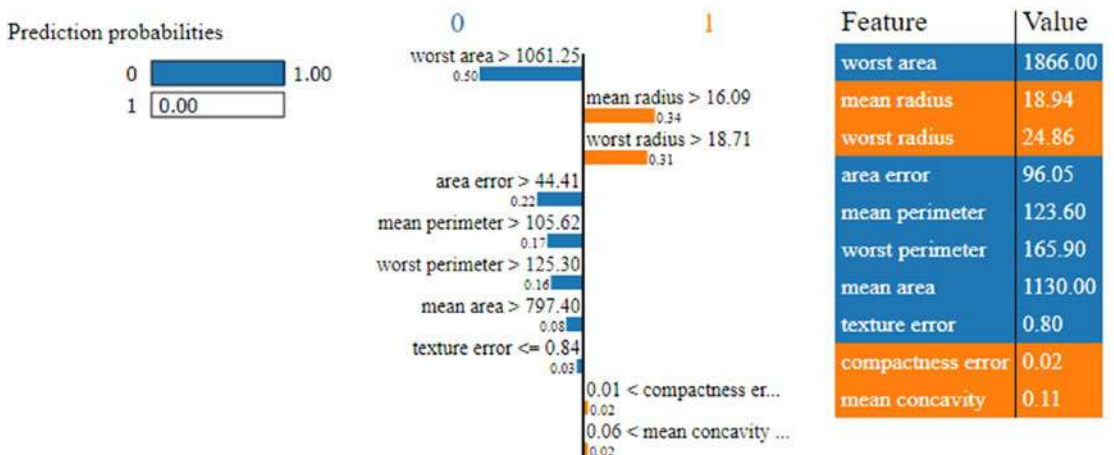

**Figure 5-21.** Model interpretation for our logistic regression model's prediction for a data point having cancer (malignant)

The results depicted in Figure 5-21 once again show us the features that were primarily responsible for the model to predict the data point as label 0, i.e. having malignant cancer. The feature `worst_area` was again the most influential one and you can notice the stark difference in its value as compared to the previous data point. Hopefully this should give you some insight into how model interpretation works. A point to remember here is that we are just getting started with model interpretation based on the recent interest since 2016, but it is going to be a good and worthwhile journey toward making models easy to understand for anyone!

## Model Deployment

The tough part of the whole modeling process is mostly the iterative process of feature engineering, model building, tuning, and evaluation. Once we are done with this iterative process of model development, we can breathe a sigh of relief—but not for long! The final piece of the Machine Learning modeling puzzle is that of deploying the model in production so that we actually start using it. In this section, you learn of the various ways you can deploy your models in action and the necessary dependencies that must be taken care of in this process.

## Model Persistence

Model persistence is the simplest way of deploying a model. In this scheme of things we will persist our final model on permanent media like our hard drive and use this persisted version for making predictions in the future. This simple scheme is a good way to deploy models with minimal effort. Model development is generally done on a static data source but once deployed, typically the model is used on a constant stream of data either in real-time/near-real-time or in batches. For example, consider a bank fraud detection model; at the time of model development, we will have data collected over some historical time span. We will use this data for the model development process and come up with a model with good performance, i.e. a model that is very good at flagging potential fraud transactions. The model then needs to be deployed over all of the future transactions that the bank (or any other financial entity) conducts. It means that for all the transactions, we need to extract the data required for our model and feed that data to our model. The model prediction is attached to the transaction and on the basis of it the transaction is flagged as a fraud transaction or a clean transaction.

In the simplest scheme of things, we can write a standalone Python script that is given the new data as soon as it arrives. It performs the necessary data transformations on the raw data and then reads our model from the permanent data store. Once we have the data and the model we can make a prediction and this prediction communication can be integrated with the required operations. These required operations are often tied to the business needs of the model. In our case of tagging fraudulent transactions, it can involve notifying the fraud department or simply denying the transaction. Most of the steps involved in this process like data acquisition/retrieval, extraction, feature engineering and actions to be taken upon prediction are related to the software or data engineering process and require custom software development and tinkering with data engineering processes like ETL (extract-transform-load).

For persisting our model to disk, we can leverage libraries like `pickle` or `joblib`, which is also available with `scikit-learn`. This allows us to deploy and use the model in the future, without having to retrain it each time we want to use it.

```
from sklearn.externals import joblib
joblib.dump(logistic, 'lr_model.pkl')
```



This code will persist our model on the disk as a file named `lr_model.pkl`. So whenever we will load this object in memory again we will get the logistic regression model object.

```
lr = joblib.load('lr_model.pkl')
lr

LogisticRegression(C=1.0, class_weight=None, dual=False, fit_intercept=True,
                  intercept_scaling=1, max_iter=100, multi_class='ovr', n_jobs=1,
                  penalty='l2', random_state=None, solver='liblinear', tol=0.0001,
                  verbose=0, warm_start=False)
```

We can now use this `lr` object, which is our model loaded from the disk, and make predictions. A sample is depicted as follows.

```
print(lr.predict(X_test[10:11]), y_test[10:11])

[1] [1]
```

Remember that once you have a persisted model, you can easily integrate it with a Python based script or application that can be scheduled to predict in realtime or batches of new data. However, proper engineering of the solution is necessary to ensure the right data reaches the model and the prediction output should also be broadcasted to the right channels.

## Custom Development

Another option to deploy a model is by developing the implementation of model prediction method separately. The output of most Machine Learning algorithms is just the values of parameters that were learned. Once we have extracted these parameter values, the prediction process is pretty straightforward. For example, the prediction of a logistic regression can be done by multiplying the coefficient vector with the input data vector. This simple calculation will give us the score for the data vector that we can feed to the sigmoid\logistic function and extract the prediction for our input data.

This method has more roots in the software development process as the developed model is reduced to a set of configurations and parameters and the main focus would be on engineering the data and the necessary mathematical computations using some programming language. This configuration can be used to develop a custom implementation pipeline in which the prediction process is just a simple mathematical operation.

## In-House Model Deployment

A lot of enterprises and organizations will not want to expose their private and confidential data on which models need to be built and deployed. Hence they will be leveraging their own software and Data Science expertise to build and deploy custom solutions on their own infrastructure. This can involve leveraging commercial-off-the-shelf tools to deploy models or using custom open source tools and frameworks. Python based models can be easily integrated with frameworks like Flask or Django to create REST APIs or Micro-services on top of the prediction models and these API endpoints can then be exposed and integrated with any other solutions or applications that might need it.

## Model Deployment as a Service

The computational world is seeing a surge of the cloud and the XAAS (*anything* as a service) model in all areas. This is also true for model development and deployment. Major providers like Google, Microsoft, and Amazon Web Services (AWS) provide the facility of developing Machine Learning models using their cloud services and also the facility of deploying those models as a service on the cloud. This is very beneficial to the end users due to the reliability and ease of scaling offered by these service providers. A major downside to custom development or deploying models in-house is the extra work and maintenance required. The scalability of the solution is also another problem that may exist for some kind of models like fraud prediction, due to the sheer number of prediction volumes required.

Model deployment as a service takes care of these issues as in most cases the model prediction can be accessed via a request made to a cloud based API endpoint (by supplying in the necessary data of course). This capability frees the burden of maintaining an extra system for the developers of the application that will be consuming the outputs of our model. In most cases, if the developers can take care of passing the required data to the model deployment APIs, they don't have to deal with the computational requirement of the prediction system and dealing with its maintenance.

Another advantage of cloud deployment comes from how easy it is to update the models. Model development is an iterative process and the deployed models need to be updated from time to time to maintain their relevance. By maintaining the models at a single end point in the cloud, we simplify the process of model updating as only a single replacement is required, which can actually happen with the push of a button, which also syncs with all downstream applications.

## Summary

This chapter concludes the second part of this book, which focused on the Machine Learning pipeline. We learned the most important aspects of the model building process, which include model training, tuning, evaluation, interpretation, and deployment. Details of various types of models was discussed in the model building section including classification, regression, and clustering models. We also covered the three vital stages of any Machine Learning process with an example of the logistic regression model and how gradient descent is an important optimization process. Hands-on examples of classification and clustering model building processes were depicted on real datasets. Various strategies of evaluating classification, regression, and clustering models were also covered with detailed metrics for each of them, which were depicted with real examples. A section of this book has been completely dedicated to tuning of models that include strategies for hyperparameter tuning and cross validation with detailed depiction of tuning on real models. A nascent field in Machine Learning is model interpretation, where we try to understand and explain how model predictions really work. Detailed coverage on various aspects of model interpretation have also been covered, including feature importances, partial dependence plots, and prediction explanations. Finally, we also looked at some aspects pertaining to model deployment and the various options for deploying models. This should give you a good idea of how to start building and tuning models. We will reinforce these concepts and methodologies in the third part of this book where we will be working on real-world case studies.

**PART III**



# **Real-World Case Studies**

## CHAPTER 6



# Analyzing Bike Sharing Trends

“All work and no play” is a well-known proverb and we certainly do not want to be dull. So far, we have covered the theoretical concepts, frameworks, workflows, and tools required to solve Data Science problems. The use case driven theme begins with this chapter. In this section of the book, we cover a wide range of Machine Learning/Data Science concepts through real life case studies. Through this and subsequent chapters, we will discuss and apply concepts learned so far to solve some exciting real-world problems.

This chapter discusses regression based models to analyze data and predict outcomes. In particular, we will utilize the Capital Bike Sharing dataset from the UCI Machine Learning Repository to understand regression models to predict bike usage demand. Through this chapter, we cover the following topics:

- *The Bike Sharing dataset* to understand the dataset available from the UCI Machine Learning Repository
- *Problem statement* to formally define the problem to be solved
- *Exploratory data analysis* to explore and understand the dataset at hand
- *Regression analysis* to understand regression modeling concepts and apply them to solve the problem

## The Bike Sharing Dataset

The CRISP-DM model introduced in the initial chapters talks about a typical workflow associated with a Data Science problem/project. The workflow diagram has data at its center for a reason. Before we get started on different techniques to understand and play with the data, let's understand its origins.

The Bike Sharing dataset is available from the UCI Machine Learning Repository. It is one of the largest and probably also the longest standing online repository of datasets used in all sorts of studies and research from across the world. The dataset we will be utilizing is one such dataset from among hundreds available on the web site.

The dataset was donated by University of Porto, Portugal in 2013. More information is available at <https://archive.ics.uci.edu/ml/datasets/Bike+Sharing+Dataset>.

---

■ **Note** We encourage you to check out the UCI Machine Learning Repository and particularly the Bike Sharing Data Set page. We thank Fanaee et al. for their work and sharing the dataset through the UCI Machine Learning Repository.

*Fanaee-T, Hadi, and Gama, Joao, Event labeling combining ensemble detectors and background knowledge, Progress in Artificial Intelligence (2013): pp. 1-15, Springer Berlin Heidelberg.*

---

## Problem Statement

With environmental issues and health becoming trending topics, usage of bicycles as a mode of transportation has gained traction in recent years. To encourage bike usage, cities across the world have successfully rolled out bike sharing programs. Under such schemes, riders can rent bicycles using manual/automated kiosks spread across the city for defined periods. In most cases, riders can pick up bikes from one location and return them to any other designated place.

The bike sharing platforms from across the world are hotspots of all sorts of data, ranging from travel time, start and end location, demographics of riders, and so on. This data along with alternate sources of information such as weather, traffic, terrain, and so on makes it an attractive proposition for different research areas.

The Capital Bike Sharing dataset contains information related to one such bike sharing program underway in Washington DC. Given this augmented (bike sharing details along with weather information) dataset, can we forecast bike rental demand for this program?

## Exploratory Data Analysis

Now that we have an overview of the business case and a formal problem statement, the very next stage is to explore and understand the data. This is also called the *Exploratory Data Analysis (EDA)* step. In this section, we will load the data into our analysis environment and explore its properties. It is worth mentioning again that EDA is one of the most important phases in the whole workflow and can help with not just understanding the dataset, but also in presenting certain fine points that can be useful in the coming steps.

---

■ **Note** The bike sharing dataset contains day level and hour level data. We will be concentrating only on hourly data available in `hour.csv`.

---

## Preprocessing

The EDA process begins with loading the data into the environment, getting a quick look at it along with count of records and number of attributes. We will be making heavy use of `pandas` and `numpy` to perform data manipulation and related tasks. For visualization purposes, we will use `matplotlib` and `seaborn` along with `pandas`' visualization capabilities wherever possible.

We begin with loading the `hour.csv` and checking the shape of the loaded dataframe. The following snippet does the same.

```
In [2]: hour_df = pd.read_csv('hour.csv')
...: print("Shape of dataset::{}".format(hour_df.shape))
```

```
Shape of dataset::(17379, 17)
```

The dataset contains more than 17k records with 17 attributes. Let's check the top few rows to see how the data looks. We use the `head()` utility from `pandas` for the same to get the output in [Figure 6-1](#).

	instant	dteday	season	yr	mnth	hr	holiday	weekday	workingday	weathersit	temp	atemp	hum	windspeed	casual	registered	cnt
0	1	2011-01-01	1	0	1	0	0	6	0	1	0.24	0.2879	0.81	0.0	3	13	16
1	2	2011-01-01	1	0	1	1	0	6	0	1	0.22	0.2727	0.80	0.0	8	32	40
2	3	2011-01-01	1	0	1	2	0	6	0	1	0.22	0.2727	0.80	0.0	5	27	32
3	4	2011-01-01	1	0	1	3	0	6	0	1	0.24	0.2879	0.75	0.0	3	10	13
4	5	2011-01-01	1	0	1	4	0	6	0	1	0.24	0.2879	0.75	0.0	0	1	1

**Figure 6-1.** Sample rows from Bike Sharing dataset

The data seems to have loaded correctly. Next, we need to check what data types pandas has inferred and if any of the attributes require type conversions. The following snippet helps us check the data types of all attributes.

```
In [3]: hour_df.dtypes
Out[3]:
instant          int64
dteday           object
season           int64
yr               int64
mnth             int64
hr               int64
holiday          int64
weekday          int64
workingday       int64
weathersit       int64
temp             float64
atemp            float64
hum              float64
windspeed       float64
casual           int64
registered       int64
cnt              int64
dtype: object
```

As mentioned in the documentation for the dataset, there are bike sharing as well as weather attributes available. The attribute `dteday` would require type conversion from `object` (or `string` type) to `timestamp`. Attributes like `season`, `holiday`, `weekday`, and so on are inferred as integers by pandas, and they would require conversion to categoricals for proper understanding.

Before jumping into type casting attributes, the following snippet cleans up the attribute names to make them more understandable and *pythonic*.

```
In [4]: hour_df.rename(columns={'instant':'rec_id',
...:                          'dteday':'datetime',
...:                          'holiday':'is_holiday',
...:                          'workingday':'is_workingday',
...:                          'weathersit':'weather_condition',
...:                          'hum':'humidity',
...:                          'mnth':'month',
...:                          'cnt':'total_count',
...:                          'hr':'hour',
...:                          'yr':'year'},inplace=True)
```

Now that we have attribute names cleaned up, we perform type-casting of attributes using utilities like `pd.to_datetime()` and `astype()`. The following snippet gets the attributes into proper data types.

```
In [5]: # date time conversion
...: hour_df['datetime'] = pd.to_datetime(hour_df.datetime)
...:
...: # categorical variables
...: hour_df['season'] = hour_df.season.astype('category')
...: hour_df['is_holiday'] = hour_df.is_holiday.astype('category')
...: hour_df['weekday'] = hour_df.weekday.astype('category')
...: hour_df['weather_condition'] = hour_df.weather_condition.astype('category')
...: hour_df['is_workingday'] = hour_df.is_workingday.astype('category')
...: hour_df['month'] = hour_df.month.astype('category')
...: hour_df['year'] = hour_df.year.astype('category')
...: hour_df['hour'] = hour_df.hour.astype('category')
```

## Distribution and Trends

The dataset after preprocessing (which we performed in the previous step) is ready for some visual inspection. We begin with visualizing hourly ridership counts across the seasons. The following snippet uses `seaborn`'s `pointplot` to visualize the same.

```
In [6]: fig,ax = plt.subplots()
...: sn.pointplot(data=hour_df[['hour',
...:                          'total_count',
...:                          'season']],
...:              x='hour',y='total_count',
...:              hue='season',ax=ax)
...: ax.set(title="Season wise hourly distribution of counts")
```

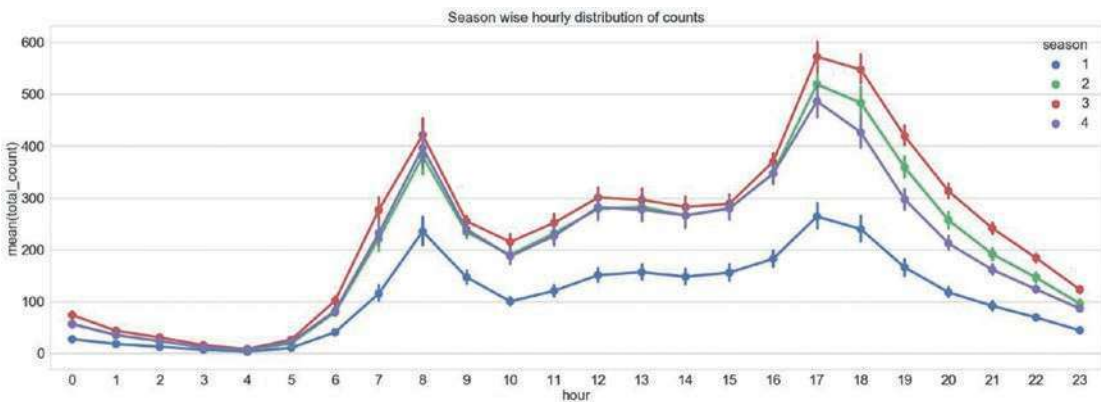

**Figure 6-2.** Season wise hourly data distribution

The plot in Figure 6-2 shows similar trends for all seasons with counts peaking in the morning between 7-9 am and in the evening between 4-6 pm, possibly due to high movement during start and end of office hours. The counts are lowest for the spring season, while fall sees highest riders across all 24 hours.

Similarly, distribution of ridership across days of the week also presents interesting trends of higher usage during afternoon hours over weekends, while weekdays see higher usage during mornings and evenings. The code for the same is available in the jupyter notebook `bike_sharing_eda.ipynb`. The plot is as shown in Figure 6-3.

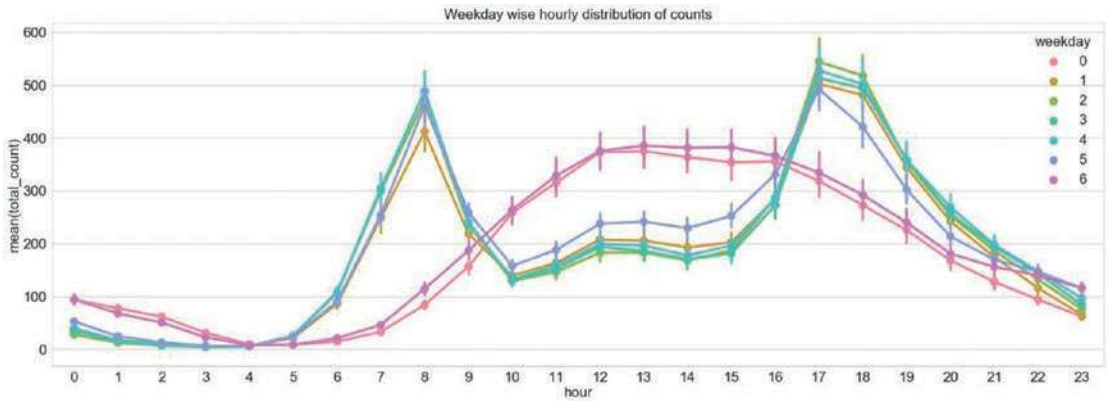
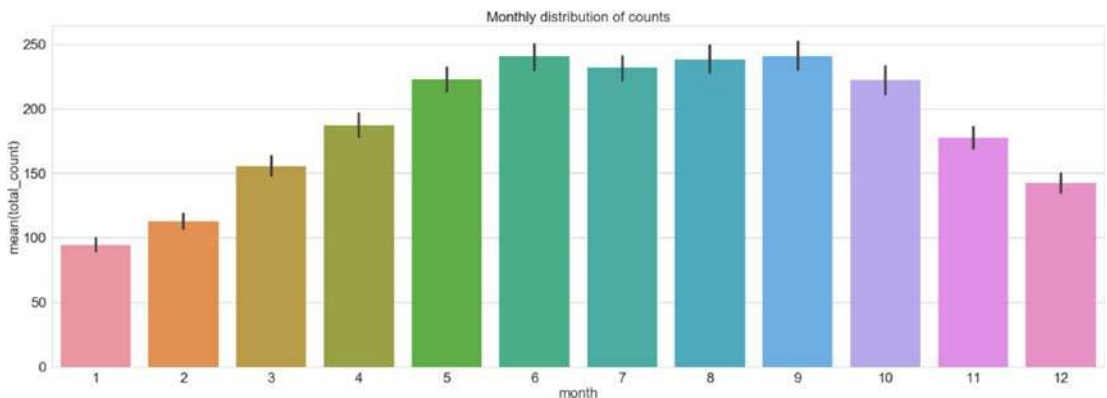

**Figure 6-3.** Day-wise hourly data distribution

Having observed hourly distribution of data across different categoricals, let's see if there are any aggregated trends. The following snippet helps us visualize monthly ridership trends using seaborn's `barplot()`.

```
In [7]: fig,ax = plt.subplots()
...: sn.barplot(data=hour_df[['month',
...:                        'total_count']],
...:            x="month",y="total_count")
...: ax.set(title="Monthly distribution of counts")
```

The generated barplot showcases a definite trend in ridership based on month of the year. The months June-September see highest ridership. Looks like Fall is a good season for Bike Sharing programs in Washington, D.C. The plot is shown in Figure 6-4.



**Figure 6-4.** Month-wise ridership distribution



We encourage you to try and plot the four seasons across different subplots as an exercise to employ plotting concepts and see the trends for each season separately.

Moving up the aggregation level, let's look at the distribution at year level. Our dataset contains year value of 0 representing 2011 and 1 representing 2012. We use a violin plot to understand multiple facets of this distribution in a crisp format.

**■ Note** *Violin plots* are similar to boxplots. Like boxplots, violin plots also visualize inter-quartile range and other summary statistics like mean/median. Yet these plots are more powerful than standard boxplots due to their ability to visualize probability density of data. This is particularly helpful if data is multimodal.

The following snippet plots yearly distribution on violin plots.

```
In [8]: sn.violinplot(data=hour_df[['year',
...:                          'total_count']],
...:                  x="year",y="total_count")
```

Figure 6-5 clearly helps us understand the multimodal distribution in both 2011 and 2012 ridership counts with 2011 having peaks at lower values as compared to 2012. The spread of counts is also much more for 2012, although the max density for both the years is between 100-200 rides.

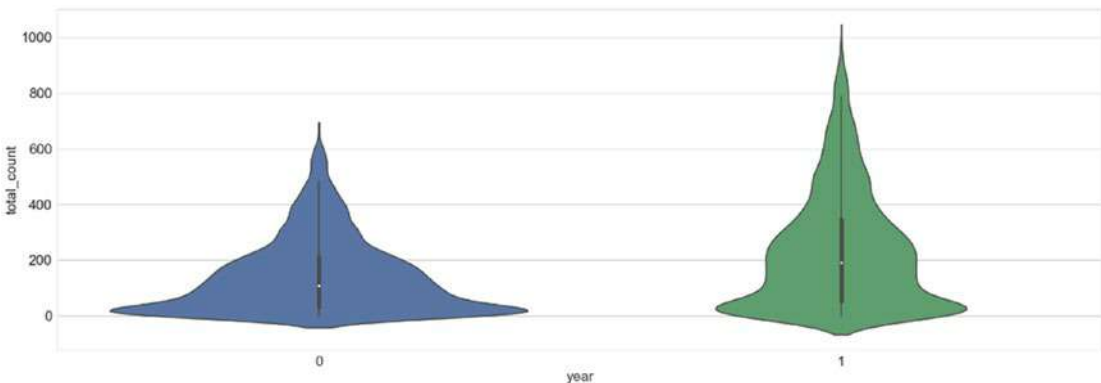

**Figure 6-5.** *Violin plot showcasing year-wise ridership distribution*

## Outliers

While exploring and learning about any dataset, it is imperative that we check for extreme and unlikely values. Though we handle missing and incorrect information while preprocessing the dataset, outliers are usually caught during EDA. Outliers can severely and adversely impact the downstream steps like modeling and the results.

We usually utilize boxplots to check for outliers in the data. In the following snippet, we analyze outliers for numeric attributes like `total_count`, `temperature`, and `wind_speed`.

```
In [9]: fig,(ax1,ax2)= plt.subplots(ncols=2)
...: sn.boxplot(data=hour_df[['total_count',
...:                          'casual','registered']],ax=ax1)
...: sn.boxplot(data=hour_df[['temp','windspeed']],ax=ax2)
```

The generated plot is shown in Figure 6-6. We can easily mark out that for the three count related attributes, all of them seem to have a sizable number of outlier values. The casual rider distribution has overall lower numbers though. For weather attributes of temperature and wind speed, we find outliers only in the case of wind speed.

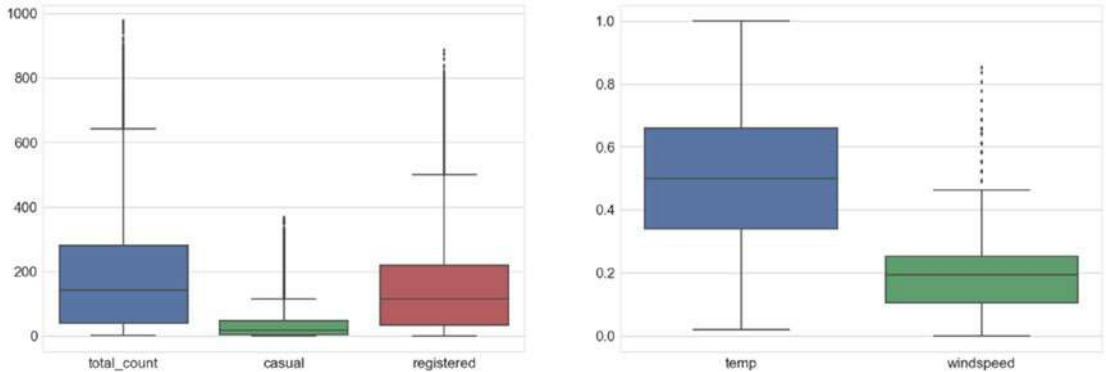

**Figure 6-6.** Outliers in the dataset

We can similarly try to check outliers at different granularity levels like hourly, monthly, and so on. The visualization in Figure 6-7 showcases boxplots at hourly level (the code is available in the `bike_sharing_edu.ipynb` jupyter notebook).

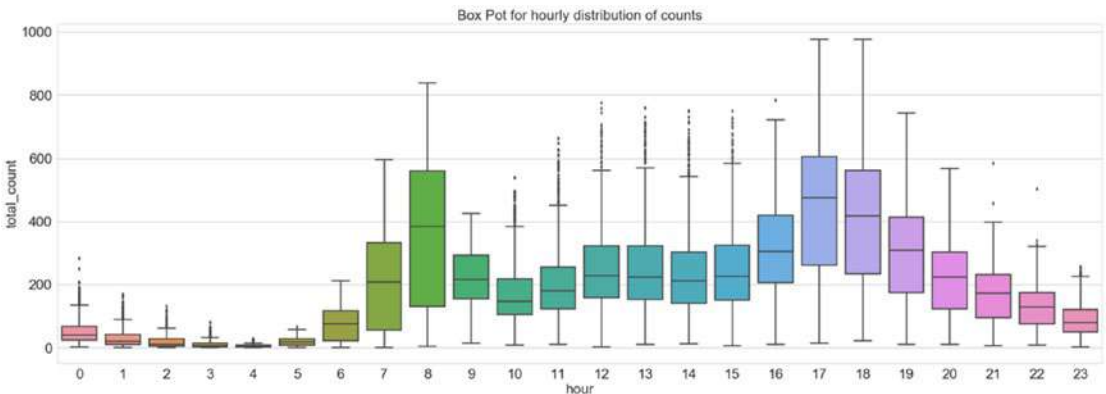

**Figure 6-7.** Outliers in hourly distribution of ridership

## Correlations

Correlation helps us understand relationships between different attributes of the data. Since this chapter focuses on forecasting, correlations can help us understand and exploit relationships to build better models.

**Note** It is important to understand that correlation does not imply causation. We strongly encourage you to explore more on the same.

The following snippet first prepares a correlational matrix using the pandas utility function `corr()`. It then uses a heat map to plot the correlation matrix.

```
In [10]: corrMatt = hour_df[["temp","atemp",
...:                        "humidity","windspeed",
...:                        "casual","registered",
...:                        "total_count"]].corr()
...: mask = np.array(corrMatt)
...: mask[np.tril_indices_from(mask)] = False
...: sn.heatmap(corrMatt, mask=mask,
...:            vmax=.8, square=True,annot=True)
```

Figure 6-8 shows the output correlational matrix (heat map) showing values in the lower triangular form on a blue to red gradient (negative to positive correlation).

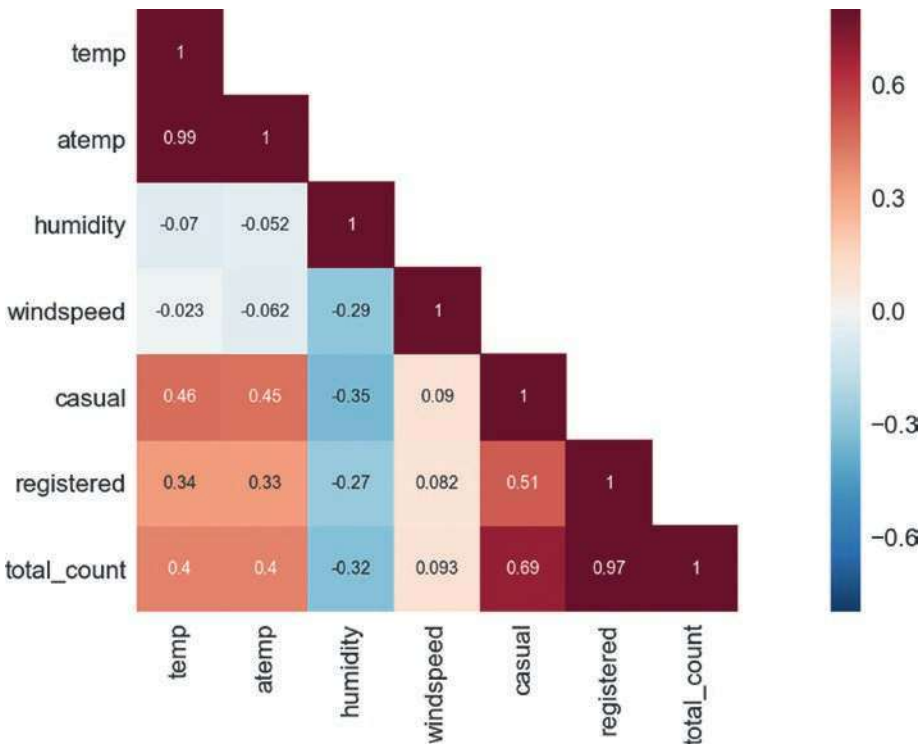

Figure 6-8. Correlational matrix

The two count variables, `registered` and `casual`, show obvious strong correlation to `total_count`. Similarly, `temp` and `atemp` show high correlation. `wind_speed` and `humidity` have slight negative correlation. Overall, none of the attributes show high correlational statistics.

## Regression Analysis

Regression analysis is a statistical modeling technique used by statisticians and Data Scientists alike. It is the process of investigating relationships between dependent and independent variables. Regression itself includes a variety of techniques for modeling and analyzing relationships between variables. It is widely used for predictive analysis, forecasting, and time series analysis.

The dependent or target variable is estimated as a function of independent or predictor variables. The estimation function is called the *regression function*.

---

■ **Note** In a very abstract sense, regression is referred to estimation of continuous response/target variables as opposed to classification, which estimates discrete targets.

---

The height-weight relationship is a classic example to get started with regression analysis. The example states that weight of a person is dependent on his/her height. Thus, we can formulate a regression function to estimate the weight (dependent variable) given height (independent variable) of a person, provided we have enough training examples. We discuss more on this in the coming section.

Regression analysis models the relationship between dependent and independent variables. It should be kept in mind that correlation between dependent and independent variables does not imply causation!

## Types of Regression

There are multiple techniques that have evolved over the years and that help us perform regression analysis. In general, all regression modeling techniques involve the following:

- The independent variable  $X$
- The dependent or target variable  $Y$
- Unknown parameter(s), denoted as  $\beta$

Thus, a regression function relates these entities as:

$$Y = f(X, \beta)$$

The function  $f()$  needs to be specified or learned from the dataset available. Depending upon the data and use case at hand, the following are commonly used regression techniques:

- **Linear regression:** As the name suggests, it maps linear relationships between dependent and independent variables. The regression line is a straight line in this technique. The aim here is to minimize the error (sum of squared error for instance).
- **Logistic regression:** In cases where the dependent variable is binary (0/1 or Yes/No), this technique is utilized. It helps us determine the probability of the binary target variable. It derives its name from the *logit* function used by this technique. The aim here is to maximize the likelihood of observed values. This technique has more in common with classification techniques than regression.

- **Non-linear regression:** In cases where dependent variable is related polynomially to independent variable, i.e. the regression function has independent variables' power of more than 1. It is also termed as *polynomial regression*.

Regression techniques may also be classified as *non-parametric*.

## Assumptions

Regression analysis has a few general assumptions while specific analysis techniques have added (or reduced) assumptions as well. The following are important general assumptions for regression analysis:

- The training dataset needs to be representative of the population being modeled.
- The independent variables are linearly independent, i.e., one independent variable cannot be explained as a linear combination of others. In other words, there should be no *multicollinearity*.
- *Homoscedasticity* of error, i.e. the variance of error, is consistent across the sample.

## Evaluation Criteria

Evaluation of model performance is an important aspect of Data Science use cases. We should be able to not just understand the outcomes but also evaluate how models compare to each other or whether the performance is acceptable or not.

In general, evaluation metrics and performance guidelines are pretty use case and domain specific, regression analysis often uses a few standard metrics.

## Residual Analysis

Regression is an estimation of target variable using the regression function on explanatory variables. Since the output is an approximation, there will be some difference between the predicted value of target and the observed value.

*Residual* is the difference between the observed and the predicted (output of the regression function). Mathematically, the residual or difference between the observed and the predicted value of the  $i$ th data point is given as:

$$e_i = y_i - f(x_i, \beta)$$

A regression model that has nicely fit the data will have its residuals display randomness (i.e., lack of any pattern). This comes from the *homoscedasticity* assumption of regression modeling. Typically scatter plots between residuals and predictors are used to confirm the assumption. Any pattern, results in a violation of this property and points toward a poor fitting model.

## Normality Test (Q-Q Plot)

This is a visual/graphical test to check for normality of the data. This test helps us identify outliers, skewness, and so on. The test is performed by plotting the data verses theoretical quartiles. The same data is also plotted on a histogram to confirm normality. The following are sample plots showcasing data confirming the normality test (see Figure 6-9).

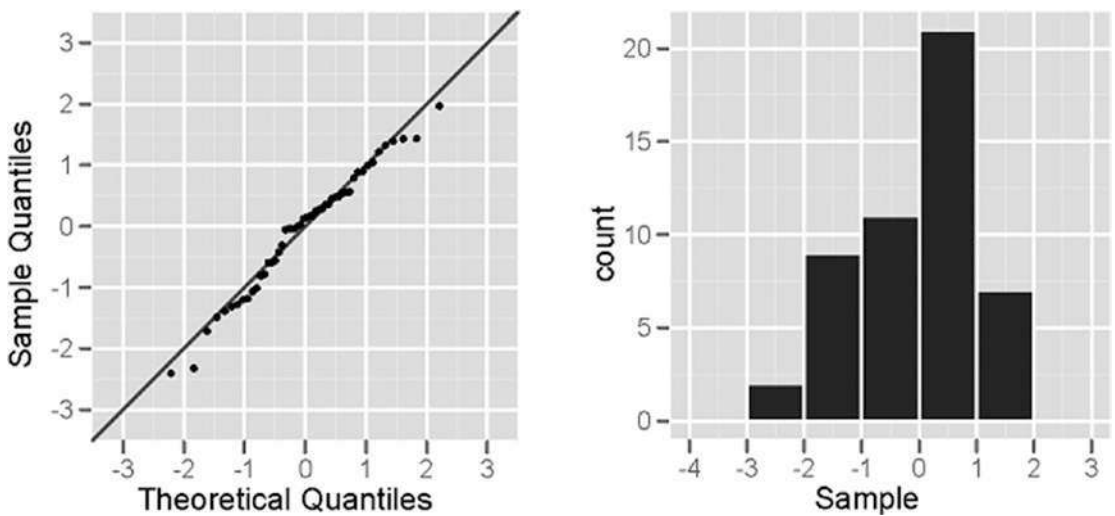

**Figure 6-9.** Normal plot (Q-Q plot) on the left and histogram to confirm normality on the right

Any deviation from the straight line in normal plot or skewness/multi-modality in histogram shows that the data does not pass the normality test.

## R-Squared: Goodness of Fit

*R-Squared* or the *coefficient of determination* is another measure used to check for goodness of fit for regression analysis. It is a measure used to determine if the regression line is able to indicate the variance in dependent variable as explained by the independent variables(s).

R-squared is a numeric value between 0 and 1, with 1 pointing to the fact that the independent variable(s) are able to explain the variance in dependent variable. Values closer to 0 are indicative of poor fitting models.

## Cross Validation

As discussed in Chapter 5, model generalization is also an important aspect of working on Data Science problems. A model which overfits its training set may perform poorly on unseen data and lead to all sorts of problems and business impacts. Hence, we employ *k-fold cross validation* on regression models as well to make sure there is no overfitting happening.

## Modeling

The stage is now set to start modeling our Bike Sharing dataset and solve the business problem of predicting bike demand for a given date time. We will utilize the concepts of regression analysis discussed in the previous section to model and evaluate the performance of our models.

The dataset was analyzed and certain transformations like renaming attributes and type casting were performed earlier in the chapter. Since the dataset contains multiple categorical variables, it is imperative that we encode the nominal ones before we use them in our modeling process.

The following snippet showcases the function to one hot encode categorical variables, based on methodologies we discussed in detail in Chapter 4: Feature Engineering and Selection.

```
def fit_transform_ohe(df,col_name):
    """This function performs one hot encoding for the specified
        column.

    Args:
        df(pandas.DataFrame): the data frame containing the mentioned column name
        col_name: the column to be one hot encoded

    Returns:
        tuple: label_encoder, one_hot_encoder, transformed column as pandas Series

    """
    # label encode the column
    le = preprocessing.LabelEncoder()
    le_labels = le.fit_transform(df[col_name])
    df[col_name+'_label'] = le_labels
    # one hot encoding
    ohe = preprocessing.OneHotEncoder()
    feature_arr = ohe.fit_transform(df[[col_name+'_label']]).toarray()
    feature_labels = [col_name+'_'+str(cls_label) for cls_label in le.classes_]
    features_df = pd.DataFrame(feature_arr, columns=feature_labels)
    return le,ohe,features_df
```

We use the `fit_transform_ohe()` function along with `transform_ohe()` to encode the categoricals. The Label and One Hot encoders are available as part of `scikit-learn`'s preprocessing module.

---

■ **Note** We will be using `scikit` and `sklearn` interchangeably in the coming sections.

---

As discussed in the earlier chapters, we usually divide the dataset at hand into training and testing sets to evaluate the performance of our models. In this case as well, we use `scikit-learn`'s `train_test_split()` function available through `model_selection` module. We split our dataset into 67% and 33% as train and test, respectively. The following snippet showcases the same.

```
In [11]: X, X_test, y, y_test = train_test_split(hour_df.iloc[:,0:-3],
...:                                          hour_df.iloc[:, -1],
...:                                          test_size=0.33,
...:                                          random_state=42)
...:
...: X.reset_index(inplace=True)
...: y = y.reset_index()
...:
...: X_test.reset_index(inplace=True)
...: y_test = y_test.reset_index()
```

The following snippet loops through the list of categorical variables to transform and prepare a list of encoded attributes.

```
In [12]: cat_attr_list = ['season', 'is_holiday',
...:                    'weather_condition', 'is_workingday',
...:                    'hour', 'weekday', 'month', 'year']
...:
...: encoded_attr_list = []
...: for col in cat_attr_list:
...:     return_obj = fit_transform_ohe(X, col)
...:     encoded_attr_list.append({'label_enc': return_obj[0],
...:                             'ohe_enc': return_obj[1],
...:                             'feature_df': return_obj[2],
...:                             'col_name': col})
```

---

■ **Note** Though we have transformed all categoricals into their one-hot encodings, note that ordinal attributes such as hour, weekday, and so on do not require such encoding.

---

Next, we merge the numeric and one hot encoded categoricals into a dataframe that we will use for our modeling purposes. The following snippet helps us prepare the required dataset.

```
In [13]: feature_df_list = [X[numeric_feature_cols]]
...: feature_df_list.extend([enc['feature_df'] \
...:                        for enc in encoded_attr_list \
...:                        if enc['col_name'] in subset_cat_features])
...:
...: train_df_new = pd.concat(feature_df_list, axis=1)
...: print("Shape::{}".format(train_df_new.shape))
```

We prepared a new dataframe using numeric and one hot encoded categorical attributes from the original training dataframe. The original dataframe had 10 such attributes (including both numeric and categoricals). Post this transformation, the new dataframe has 19 attributes due to one hot encoding of the categoricals.

## Linear Regression

One of the simplest regression analysis techniques is *linear regression*. As discussed earlier in the chapter, linear regression is the analysis of relationship between the dependent and independent variables. Linear regression assumes linear relationship between the two variables. Extending on the general regression analysis notation, linear regression takes the following form:

$$Y = a + bX$$

In this equation, Y is the dependent variable, X is the independent variable. The symbol a denotes the intercept of the regression line and b is the slope of it.

Numerous lines can be fitted to a given dataset based on different combinations of the intercept (i.e. a) and slope (i.e. b). The aim is to find the best fitting line to model our data.



If we think for a second, what would a best fitting line look like? Such line would invariably have the least error/residual, i.e. the difference between the predicted and observed would be least for such a line.

The *Ordinary Least Squares* criterion is one such technique to identify the best fitting line. The algorithm tries to minimize the error with respect to slope and intercept. It uses the squared error form, shown as follows:

$$q = \sum (y_{observed} - y_{predicted})^2$$

where,  $q$  is the total squared error. We minimize the total error to get the slope and intercept of the best fitting line.

## Training

Now that we have the background on linear regression and OLS, we'll get started with the model building. The linear regression model is exposed through `scikit-learn`'s `linear_model` module. Like all Machine Learning algorithms in `scikit`, this also works on the familiar `fit()` and `predict()` theme. The following snippet prepares the linear regression object for us.

```
In [14]: X = train_df_new
...: y= y.total_count.values.reshape(-1,1)
...:
...: lin_reg = linear_model.LinearRegression()
```

One simple way of proceeding would be call the `fit()` function to build our linear regression model and then call the `predict()` function on the test dataset to get the predictions for evaluation. We also want to keep in mind the aspects of overfitting and reduce its affects and obtain a generalizable model. As discussed in the previous section and earlier chapters, cross validation is one method to keep overfitting in check.

We thus use the *k-fold cross validation* (specifically 10-fold) as shown in the following snippet.

```
In [15]: predicted = cross_val_predict(lin_reg, X, y, cv=10)
```

The function `cross_val_predict()` is exposed through `model_selection` module of `sklearn`. This function takes the model object, predictors, and targets as inputs. We specify the  $k$  in  $k$ -fold using the `cv` parameter. In our example, we use 10-fold cross validation. This function returns cross validated prediction values as fitted by the model object.

We use scatter plot to analyze our predictions. The following snippet uses `matplotlib` to generate scatter plot between residuals and observed values.

```
In [16]: fig, ax = plt.subplots()
...: ax.scatter(y, y-predicted)
...: ax.axhline(lw=2,color='black')
...: ax.set_xlabel('Observed')
...: ax.set_ylabel('Residual')
...: plt.show()
```

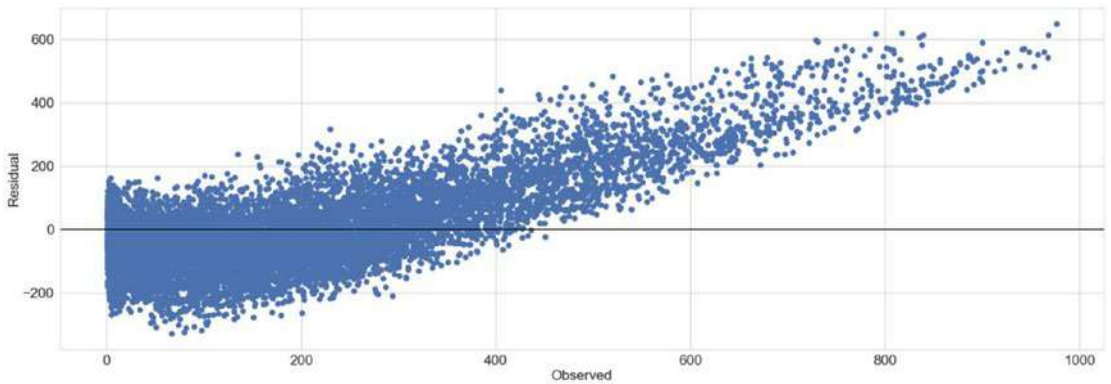

**Figure 6-10.** Residual plot

The plot in Figure 6-10 clearly violates the *homoscedasticity* assumption, which is about residuals being random and not following any pattern. To further quantify our findings related to the model, we plot the cross-validation scores. We use the `cross_val_score()` function available again as part of the `model_selection` module, which is shown in the visualization in Figure 6-11.

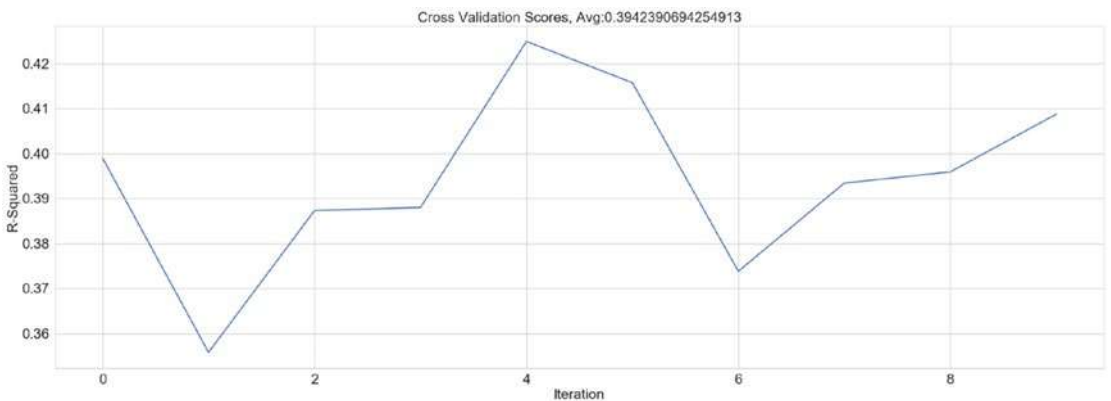

**Figure 6-11.** Cross validation scores

The r-squared or the coefficient of determination is 0.39 on an average for 10-fold cross validation. This points to the fact that the predictor is only able to explain 39% of the variance in the target variable.

You are encouraged to plot and confirm the normality of data. It is important to understand if the data can be modeled by a linear model or not. This is being left as an exercise for you to explore.

## Testing

The linear regression model prepared and evaluated in the training phase needs to be checked for its performance on a completely un-seen dataset, the testing dataset. At the beginning of this section, we used the `train_test_split()` function to keep a dataset specifically for testing purposes.

But before we can use the test dataset on the learned regression line, we need to make sure the attributes have been through the same preprocessing in both training and testing sets. Since we transformed categorical variables into their one hot encodings in the train dataset, in the following snippet we perform the same actions on the test dataset as well.

```
In [17]: test_encoded_attr_list = []
...: for enc in encoded_attr_list:
...:     col_name = enc['col_name']
...:     le = enc['label_enc']
...:     ohe = enc['ohe_enc']
...:     test_encoded_attr_list.append({'feature_df':transform_ohe(X_test,
...:                                                                le,ohe,
...:                                                                col_name),
...:                                   'col_name':col_name})
...:
...:
...:
...: test_feature_df_list = [X_test[numeric_feature_cols]]
...: test_feature_df_list.extend([enc['feature_df'] \
...:                               for enc in test_encoded_attr_list \
...:                               if enc['col_name'] in subset_cat_features])
...:
...: test_df_new = pd.concat(test_feature_df_list, axis=1)
...: print("Shape::{}".format(test_df_new.shape))
```

The transformed test dataset is shown in Figure 6-12.

	temp	humidity	windspeed	hour	weekday	month	year	season_1	season_2	season_3	season_4	is_holiday_0	is_holiday_1
0	0.80	0.27	0.1940	19	6	6	1	0.0	0.0	1.0	0.0	1.0	0.0
1	0.24	0.41	0.2239	20	1	1	1	1.0	0.0	0.0	0.0	0.0	1.0
2	0.32	0.66	0.2836	2	5	10	0	0.0	0.0	0.0	1.0	1.0	0.0
3	0.78	0.52	0.3582	19	2	5	1	0.0	1.0	0.0	0.0	1.0	0.0
4	0.26	0.56	0.3881	0	4	1	0	1.0	0.0	0.0	0.0	1.0	0.0

**Figure 6-12.** Test dataset after transformations

The final piece of the puzzle is to use the `predict()` function of the `LinearRegression` object and compare our results/predictions. The following snippet performs the said actions.

```
In [18]: X_test = test_df_new
...: y_test = y_test.total_count.values.reshape(-1,1)
...:
...: y_pred = lin_reg.predict(X_test)
...:
...: residuals = y_test-y_pred
```

We also calculate the residuals and use them to prepare the residual plot, similar to the one we created during training step. The following snippet plots the residual plot on the test dataset.

```
In [19]: fig, ax = plt.subplots()
...: ax.scatter(y_test, residuals)
```

```

...: ax.axhline(lw=2,color='black')
...: ax.set_xlabel('Observed')
...: ax.set_ylabel('Residuals')
...: ax.title.set_text("Residual Plot with R-Squared={}".format(np.average(r2_score)))
...: plt.show()

```

The generated plot shows an R-squared that is comparable to training performance. The plot is shown in Figure 6-13.

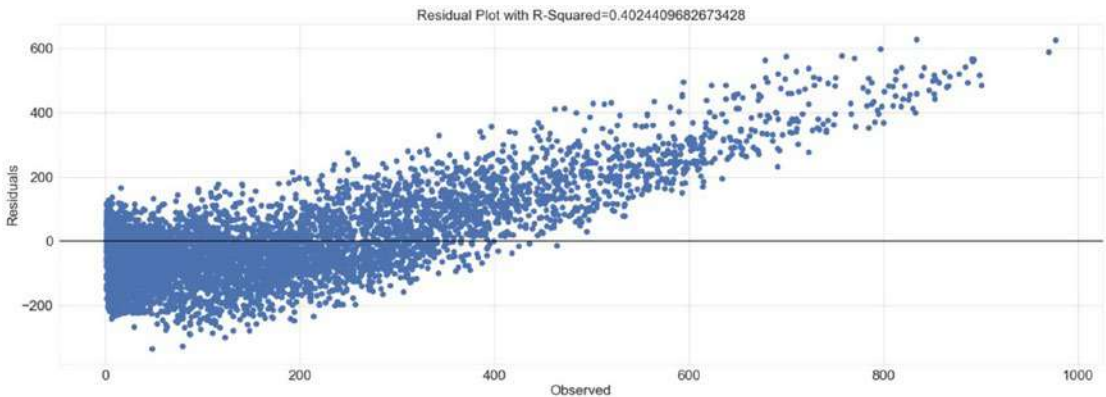

**Figure 6-13.** Residual plot for test dataset

It is clearly evident from our evaluation that the linear regression model is unable to model the data to generate decent results. Though it should be noted that the model is performing equally on both training and testing datasets. It seems like a case where we would need to model this data using methods that can model non-linear relationships.

## EXERCISE

In this section, we used training and testing datasets with 19 attributes (including both numeric and one hot encoded categoricals). The performance is dismal due to non-linearity and other factors.

Experiment with different combination of attributes (use only a subset or use only numerical attributes or any combination of them) and prepare different linear regression models. Follow the same steps as outlined in this section. Check the performance against the model prepared in this section and analyze if a better performing model could be possible.

## Decision Tree Based Regression

Decision trees are supervised learning algorithms used for both regression and classification problems. They are simple yet powerful in modeling non-linear relationships. Being a non-parametric model, the aim of this algorithm is to learn a model that can predict outcomes based on simple decision rules (for instance, if-else conditions) based on features. The *interpretability* of decision trees makes them even more lucrative, as we can visualize the rules it has inferred from the data.

We explain the concepts and terminologies related to decision trees using an example. Suppose we have a hypothetical dataset of car models from different manufacturers. Assume each data point has features like fuel\_capacity, engine\_capacity, price, year\_of\_purchase, miles\_driven, and mileage. Given this data, we need a model that can predict the mileage given other attributes.

Since decision trees are supervised learning algorithms, we have certain number of data points with actual mileage values available. A decision tree starts off at the root and divides the dataset into two or more non-overlapping subsets, each represented as child node of the root. It divides the root into subsets based on a specific attribute. It goes on performing the split at every node until a leaf node is achieved where the target value is available. There might be a lot many questions on how it all happens, and we will get to each of them in a bit. For better understanding, assume Figure 6-14 is the structure of the decision tree inferred from the dataset at hand.

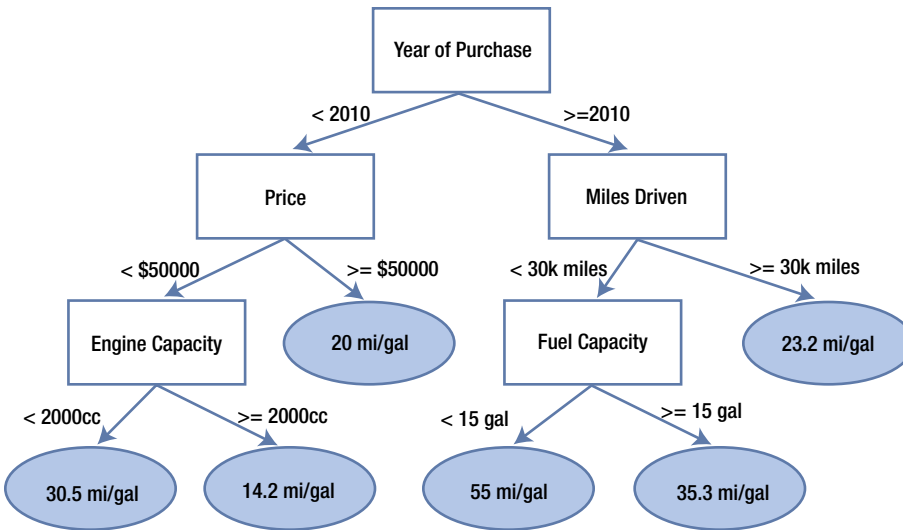

Figure 6-14. Sample decision tree

The visualization depicted in Figure 6-14 showcases a sample decision tree with leaf nodes pointing toward target values. The tree starts off by splitting the dataset at root based on year of purchase with left child representing purchases before 2010 and right child for purchases after 2010, and similarly for other nodes. When presented with new/unseen data point, we simply traverse the tree and arrive at a leaf node which determines the target value. Even though the previous example is simple, it clearly brings out the interpretability of the model as well as its ability to learn simple rules.

## Node Splitting

Decision trees work in a top-down manner and node splitting is an important concept for any decision tree algorithm. Most algorithms follow a greedy approach to divide the input space into subsets.

The basic process in simple terms is to try and split data points using different attributes/features and test against a cost function. The split resulting in least cost is selected at every step. Classification and regression problems use different set of cost functions. Some of the most common ones are as follows:

- **Mean Squared Error (MSE):** Used mainly for regression trees, it is calculated as the square of difference between observed and predicted values.

- **Mean Absolute Error:** Used for regression trees, it is similar to MSE though we only use the difference between the observed and predicted values.
- **Variance Reduction:** This was first introduced with *CART* algorithm, and it uses the standard formula of variance and we choose the split that results in least variance.
- **Gini Impurity/Index:** Mainly used by classification trees, it is a measure of a randomly chosen data point to have an incorrect label given it was labeled randomly.
- **Information Gain:** Again used mainly for classification problems, it is also termed as *entropy*. We choose the splits based on the amount of information gain. The higher information gain, the better it is.

---

■ **Note** These are some of the most commonly used cost functions. There are many more which are used under specific scenarios.

---

## Stopping Criteria

As mentioned, decision trees follow greedy recursive splitting of nodes, but how or when do they stop? There are many strategies applied to define the stopping criteria. The most common being the minimum count of data points. Node splitting is stopped if further splitting would violate this constraint. Another constraint used is the depth of the tree.

The stopping criteria together with other parameters help us achieve trees that can generalize well. A tree that is very deep or has too many non-leaf nodes often results in overfitting.

## Hyperparameters

*Hyperparameters* are the knobs and controls we set with an aim to optimize the model's performance on unseen data. These hyperparameters are different from parameters which are learned by our learning algorithm over the course of training process. Hyperparameters help us achieve objectives of avoiding overfitting and so on. Decision trees provide us with quite a few hyperparameters to play with, some of which we discussed in Chapter 5.

Maximum depth, minimum samples for leaf nodes, minimum samples to split internal nodes, maximum leaf nodes, and so on are some of the hyperparameters actively used to improve performance of decision trees. We will use techniques like grid search (refresh your memory from Chapter 5) to identify optimal values for these hyperparameters in the coming sections.

## Decision Tree Algorithms

Decision trees have been around for quite some time now. They have evolved with improvements in algorithms based on different techniques over the years. Some of the most commonly used algorithms are listed as follows:

- CART or Classification And Regression Tree
- ID3 or Iterative Dichotomizer 3
- C4.5

Now that we have a decent understanding of decision trees, let's see if we can achieve improvements by using them for our regression problem of predicting the bike sharing demand.

## Training

Similar to the process with linear regression, we will use the same preprocessed dataframe `train_df_new` with categoricals transformed into one hot encoded form along with other numerical attributes. We also split the dataset into `train` and `test` again using the `train_test_split()` utility from `scikit-learn`.

The training process for decision trees is a bit involved and different as compared to linear regression. Even though we performed cross validation while training our linear regression model, we did not have any hyperparameters to tune. In the case of decision trees, we have quite a handful of them (some of which we even discussed in the previous section). Before we get into the specifics of obtaining optimal hyperparameters, we will look at the `DecisionTreeRegressor` from `sklearn's tree` module. We do so by instantiating a regressor object with some of the hyperparameters set as follows.

```
In [1]: dtr = DecisionTreeRegressor(max_depth=4,
...:                               min_samples_split=5,
...:                               max_leaf_nodes=10)
```

This code snippet prepares a `DecisionTreeRegressor` object that is set to have a maximum depth of 4, maximum leaf nodes as 10, and minimum number of samples required to split a node as 5. Though there can be many more, this example outlines how hyperparameters are utilized in algorithms.

---

■ **Note** You are encouraged to try and fit the default Decision Tree Regressor on the training data and observe its performance on testing dataset.

---

As mentioned, decision trees have an added advantage of being interpretable. We can visualize the model object using `Graphviz` and `pydot` libraries, as shown in the following snippet.

```
In [2]: dot_data = tree.export_graphviz(dtr, out_file=None)
...: graph = pydotplus.graph_from_dot_data(dot_data)
...: graph.write_pdf("bikeshare.pdf")
```

The output is a pdf file showcasing a decision tree with hyperparameters as set in the previous step. The following plot as depicted in Figure 6-15, shows the root node being split on attribute 3 and then going on until a depth of 4 is achieved. There are some leaves at a depth lesser than 4 as well. Each node clearly marks out the attributes associated with it.

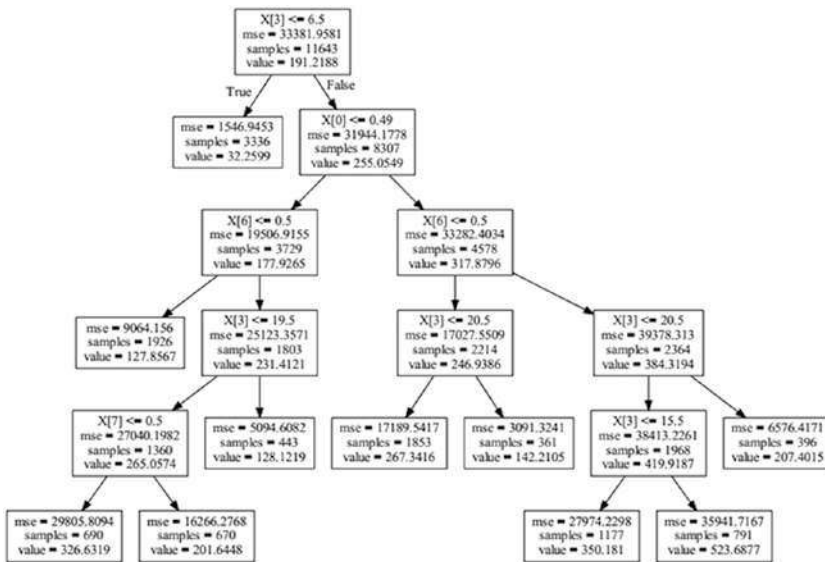

**Figure 6-15.** Decision tree with defined hyperparameters on Bike Sharing dataset

Now we start with the actual training process. As must be evident from our workflow so far, we would train our regressor using *k-fold cross validation*. Since we have hyperparameters as well in case of decision trees to worry, we need a method to fine-tune them as well.

There are many ways of fine-tuning the hyperparameters, the most common ones are grid search and random search, with grid search being the more popular one. As the name suggests, random search randomly searches the combinations of hyperparameters to find the best combination, grid search on the other hand is a more systematic approach where all combinations are tried before the best is identified. To make our lives easier, `sklearn` provides a utility to grid search the hyperparameters while cross validating the model using the `GridSearchCV()` method from `model_selection` module.

The `GridSearchCV()` method takes the Regression/Classifier object as input parameter along with a dictionary of hyperparameters, number of cross validations required, and a few more. We use the following dictionary to define our grid of hyperparameters.

```
In [3]: param_grid = {"criterion": ["mse", "mae"],
...:                 "min_samples_split": [10, 20, 40],
...:                 "max_depth": [2, 6, 8],
...:                 "min_samples_leaf": [20, 40, 100],
...:                 "max_leaf_nodes": [5, 20, 100, 500, 800],
...: }
```

The dictionary basically provides a list of feasible values for each of the hyperparameters that we want to fine-tune. The hyperparameters are the keys, while the values are presented as list of possible values of these hyperparameters. For instance, our dictionary provides `max_depth` with possible values of 2, 6, and 8 levels. The `GridSearchCV()` function will in turn search in this defined list of possible values to arrive at the best one value. The following snippet prepares a `GridSearchCV` object and fits our training dataset to it.

```
In [4]: grid_cv_dtr = GridSearchCV(dtr, param_grid, cv=5)
```



The grid search of hyperparameters with *k-fold cross validation* is an iterative process wrapped, optimized, and standardized by `GridSearchCV()` function. The training process takes time due to the same and results in quite a few useful attributes to analyze. The `best_score_` attribute helps us get the best cross validation score our Decision Tree Regressor could achieve. We can view the hyperparameters for the model that generates the best score using `best_params_`. We can view the detailed information of each iteration of `GridSearchCV()` using the `cv_results_` attribute. The following snippet showcases some of these attributes.

```
In [5]: print("R-Squared:{}".format(grid_cv_dtr.best_score_))
...: print("Best Hyperparameters:\n{}".format(grid_cv_dtr.best_params_))
```

```
R-Squared::0.85891903233008
Best Hyperparameters::
{'min_samples_split': 10, 'max_depth': 8, 'max_leaf_nodes': 500, 'min_samples_leaf': 20,
'criterion': 'mse'}
```

The results are decent and show a dramatic improvement over our linear regression model. Let's first try to understand the learning/model fitting results across different settings of this model fitting. To get to different models prepared during our grid search, we use the `cv_results_` attribute of our `GridSearchCV` object. The `cv_results_` attribute is a numpy array that we can easily convert to a pandas dataframe. The dataframe is shown in Figure 6-16.

	mean_fit_time	mean_score_time	mean_test_score	mean_train_score	param_criterion	param_max_depth	param_max_leaf_nodes
0	0.032285	0.004816	0.48401	0.48875	mse	2	5
1	0.035995	0.005114	0.48401	0.48875	mse	2	5
2	0.036898	0.005816	0.48401	0.48875	mse	2	5
3	0.037800	0.005315	0.48401	0.48875	mse	2	5
4	0.036095	0.007220	0.48401	0.48875	mse	2	5

**Figure 6-16.** Dataframe showcasing tuning results with a few attributes of Grid Search with CV

It is important to understand that grid search with cross validation was optimizing on finding the best set of hyperparameters that can help prepare a generalizable Decision Tree Regressor. It may be possible that there are further optimizations possible. We use `seaborn` to plot the impact of depth of the tree on the overall score along with number of leaf nodes. The following snippet uses the same dataframe we prepared using `cv_results_` attribute of `GridSearchCV` object discussed previously.

```
In [6]: fig,ax = plt.subplots()
...: sn.pointplot(data=df[['mean_test_score',
...:                       'param_max_leaf_nodes',
...:                       'param_max_depth']],
...:              y='mean_test_score',x='param_max_depth',
...:              hue='param_max_leaf_nodes',ax=ax)
...: ax.set(title="Affect of Depth and Leaf Nodes on Model Performance")
```

The output shows a sudden improvement in score as depth increases from 2 to 6 while a gradual improvement as we reach 8 from 6. The impact of number of leaf nodes is rather interesting. The difference in scores between 100 and 800 leaf nodes is strikingly not much. This is a clear indicator that further fine-tuning is possible. Figure 6-17 depicts the visualization showcasing these results.

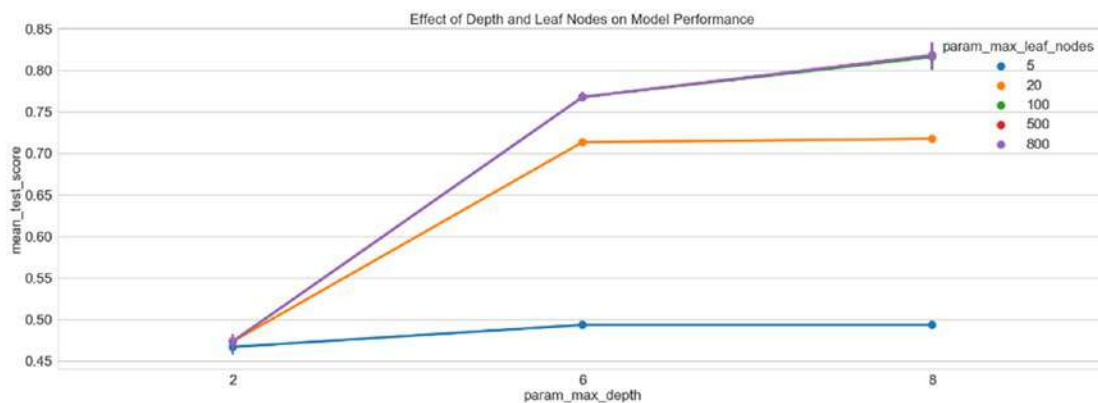

**Figure 6-17.** Mean test score and impact of tree depth and count of leaf nodes

As mentioned, there is still scope of fine-tuning to further improve the results. It is therefore a decision which is use case and cost dependent. Cost can be in terms of effort, time and corresponding improvements achieved. For now, we'll proceed with the best model our GridSearchCV object has helped us identify.

## Testing

Once we have a model trained with optimized hyperparameters, we can begin with our usual workflow to test performance on an unseen dataset. We will utilize the same preprocessing as discussed while preparing test set for linear regression (you may refer to the “Testing” section of linear regression and/or the jupyter notebook `decision_tree_regression.ipynb`). The following snippet predicts the output values for the test dataset using the best estimator achieved during training phase.

```
In [7]: y_pred = best_dtr_model.predict(X_test)
...: residuals = y_test.flatten() - y_pred
```

The final step is to view the R-squared score on this dataset. A well-fit model should have comparable performance on this set as well, the same is evident from the following snippet.

```
In [1]: print("R-squared: {}".format(r2_score))
R-squared: 0.8722
```

As is evident from the R-squared value, the performance is quite comparable to our training performance. We can conclude by saying Decision Tree Regressor was better at forecasting bike demand as compared to linear regression.

## Next Steps

Decision trees helped us achieve a better performance over linear regression based models, yet there are improvements possible. The following are a few next steps to ponder and keep in mind:

- **Model fine-tuning:** We achieved a drastic improvement from using decision trees, yet this can be improved further by analyzing the results of training, cross validation, and so on. Acceptable model performance is something that is use case dependent and is usually discussed upon while formalizing the problem statement. In our case, an R-squared of 0.8 might be very good or missing the mark, hence the results need to be discussed with all stakeholders involved.
- **Other models and ensembling:** If our current models do not achieve the performance criteria, we need to evaluate other algorithms and even ensembles. There many other regression models to explore. Ensembles are also quite useful and are used extensively.
- **Machine Learning pipeline:** The workflow shared in this chapter was verbose to assist in understanding and exploring concepts and techniques. Once a sequence of preprocessing and modeling steps have stabilized, standardized pipelines are used to maintain consistency and validity of the entire process. You are encouraged to explore sklearn's pipeline module for further details.

## Summary

This chapter introduced the *Bike Sharing* dataset from the UCI Machine Learning repository. We followed the Machine Learning workflow discussed in detail in the previous section of the book. We started off with a brief discussion about the dataset followed by formally defining the problem statement. Once we had a mission to forecast the bike demand, the next was to get started with exploratory data analysis to understand and uncover properties and patterns in the data. We utilized `pandas`, `numpy`, and `seaborn/matplotlib` to manipulate, transform, and visualize the dataset at hand. The line plots, bar charts, box plots, violin plots, etc. all helped us understand various aspects of the dataset.

We then took a detour and explored the regression analysis. The important concepts, assumptions, and types of regression analysis techniques were discussed. Briefly, we touched on various performance/evaluation criteria typically used for regression problems like residual plots, normal plots, and coefficient of determination. Equipped with a better understanding of dataset and regression itself, we started off with a simple algorithm called linear regression. It is not only a simple algorithm but one of the most well studied and extensively used algorithms for regression use cases. We utilized sklearn's `linear_model` to build and test our dataset for the problem at hand. We also utilized the `model_selection` module to split our dataset and cross validate our model. The next step saw us graduating to decision tree based regression model to improve on the performance of linear regression. We touched upon the concepts and important aspects related to decision trees before using them for modeling our dataset. The same set of preprocessing steps was used for both linear regression and decision trees. Finally, we concluded the chapter by briefly discussing about next steps for improvement and enhancements. This chapter sets the flow and context for coming chapters, which will build on the concepts and workflows from here on.

## CHAPTER 7



# Analyzing Movie Reviews Sentiment

In this chapter, we continue with our focus on case-study oriented chapters, where we will focus on specific real-world problems and scenarios and how we can use Machine Learning to solve them. We will cover aspects pertaining to natural language processing (NLP), text analytics, and Machine Learning in this chapter. The problem at hand is sentiment analysis or opinion mining, where we want to analyze some textual documents and predict their sentiment or opinion based on the content of these documents. Sentiment analysis is perhaps one of the most popular applications of natural language processing and text analytics with a vast number of websites, books and tutorials on this subject. Typically sentiment analysis seems to work best on subjective text, where people express opinions, feelings, and their mood. From a real-world industry standpoint, sentiment analysis is widely used to analyze corporate surveys, feedback surveys, social media data, and reviews for movies, places, commodities, and many more. The idea is to analyze and understand the reactions of people toward a specific entity and take insightful actions based on their sentiment.

A text corpus consists of multiple text documents and each document can be as simple as a single sentence to a complete document with multiple paragraphs. Textual data, in spite of being highly unstructured, can be classified into two major types of documents. Factual documents that typically depict some form of statements or facts with no specific feelings or emotion attached to them. These are also known as objective documents. Subjective documents on the other hand have text that expresses feelings, moods, emotions, and opinions.

*Sentiment analysis* is also popularly known as opinion analysis or opinion mining. The key idea is to use techniques from text analytics, NLP, Machine Learning, and linguistics to extract important information or data points from unstructured text. This in turn can help us derive qualitative outputs like the overall sentiment being on a positive, neutral, or negative scale and quantitative outputs like the sentiment polarity, subjectivity, and objectivity proportions. Sentiment polarity is typically a numeric score that's assigned to both the positive and negative aspects of a text document based on subjective parameters like specific words and phrases expressing feelings and emotion. *Neutral* sentiment typically has 0 polarity since it does not express any specific sentiment, *positive* sentiment will have polarity  $> 0$ , and *negative*  $< 0$ . Of course, you can always change these thresholds based on the type of text you are dealing with; there are no hard constraints on this.

In this chapter, we focus on trying to analyze a large corpus of movie reviews and derive the sentiment. We cover a wide variety of techniques for analyzing sentiment, which include the following.

- Unsupervised lexicon-based models
- Traditional supervised Machine Learning models
- Newer supervised Deep Learning models
- Advanced supervised Deep Learning models

Besides looking at various approaches and models, we also focus on important aspects in the Machine Learning pipeline including text pre-processing, normalization, and in-depth analysis of models, including model interpretation and topic models. The key idea here is to understand how we tackle a problem like sentiment analysis on unstructured text, learn various techniques, models and understand how to interpret the results. This will enable you to use these methodologies in the future on your own datasets. Let's get started!

## Problem Statement

The main objective in this chapter is to predict the sentiment for a number of movie reviews obtained from the *Internet Movie Database* (IMDb). This dataset contains 50,000 movie reviews that have been pre-labeled with “positive” and “negative” sentiment class labels based on the review content. Besides this, there are additional movie reviews that are unlabeled. The dataset can be obtained from <http://ai.stanford.edu/~amaas/data/sentiment/>, courtesy of Stanford University and Andrew L. Maas, Raymond E. Daly, Peter T. Pham, Dan Huang, Andrew Y. Ng, and Christopher Potts. This dataset was also used in their famous paper, *Learning Word Vectors for Sentiment Analysis* proceedings of the 49th Annual Meeting of the Association for Computational Linguistics (ACL 2011). They have datasets in the form of raw text as well as already processed bag of words formats. We will only be using the raw labeled movie reviews for our analyses in this chapter. Hence our task will be to predict the sentiment of 15,000 labeled movie reviews and use the remaining 35,000 reviews for training our supervised models. We will still predict sentiments for only 15,000 reviews in case of unsupervised models to maintain consistency and enable ease of comparison.

## Setting Up Dependencies

We will be using several Python libraries and frameworks specific to text analytics, NLP, and Machine Learning. While most of them will be mentioned in each section, you need to make sure you have pandas, numpy, scipy, and scikit-learn installed, which will be used for data processing and Machine Learning. Deep Learning frameworks used in this chapter include keras with the tensorflow backend, but you can also use theano as the backend if you choose to do so. NLP libraries which will be used include spacy, nltk, and gensim. Do remember to check that your installed nltk version is at least  $\geq 3.2.4$ , otherwise, the ToktokTokenizer class may not be present. If you want to use a lower nltk version for some reason, you can use any other tokenizer like the default word\_tokenize() based on the TreebankWordTokenizer. The version for gensim should be at least 2.3.0 and for spacy, the version used was 1.9.0. We recommend using the latest version of spacy which was recently released (version 2.x) as this has fixed several bugs and added several improvements. You also need to download the necessary dependencies and corpora for spacy and nltk in case you are installing them for the first time. The following snippets should get this done. For nltk you need to type the following code from a Python or ipython shell after installing nltk using either pip or conda.

```
import nltk
nltk.download('all', halt_on_error=False)
```

For spacy, you need to type the following code in a Unix shell/windows command prompt, to install the library (use pip install spacy if you don't want to use conda) and also get the English model dependency.

```
$ conda config --add channels conda-forge
$ conda install spacy
$ python -m spacy download en
```

We also use our custom developed text pre-processing and normalization module, which you will find in the files named `contractions.py` and `text_normalizer.py`. Utilities related to supervised model fitting, prediction, and evaluation are present in `model_evaluation_utils.py`, so make sure you have these modules in the same directory and the other Python files and jupyter notebooks for this chapter.

## Getting the Data

The dataset will be available along with the code files for this chapter in the GitHub repository for this book at <https://github.com/dipanjanS/practical-machine-learning-with-python> under the filename `movie_reviews.csv` containing 50,000 labeled IMDb movie reviews. You can also download the same data from <http://ai.stanford.edu/~amaas/data/sentiment/> if needed. Once you have the CSV file, you can easily load it in Python using the `read_csv(...)` utility function from pandas.

## Text Pre-Processing and Normalization

One of the key steps before diving into the process of feature engineering and modeling involves cleaning, pre-processing, and normalizing text to bring text components like phrases and words to some standard format. This enables standardization across a document corpus, which helps build meaningful features and helps reduce noise that can be introduced due to many factors like irrelevant symbols, special characters, XML and HTML tags, and so on. The file named `text_normalizer.py` has all the necessary utilities we will be using for our text normalization needs. You can also refer to the jupyter notebook named `Text Normalization Demo.ipynb` for a more interactive experience. The main components in our text normalization pipeline are described in this section.

- **Cleaning text:** Our text often contains unnecessary content like HTML tags, which do not add much value when analyzing sentiment. Hence we need to make sure we remove them before extracting features. The BeautifulSoup library does an excellent job in providing necessary functions for this. Our `strip_html_tags(...)` function enables in cleaning and stripping out HTML code.
- **Removing accented characters:** In our dataset, we are dealing with reviews in the English language so we need to make sure that characters with any other format, especially accented characters are converted and standardized into ASCII characters. A simple example would be converting `é` to `e`. Our `remove_accented_chars(...)` function helps us in this respect.
- **Expanding contractions:** In the English language, contractions are basically shortened versions of words or syllables. These shortened versions of existing words or phrases are created by removing specific letters and sounds. More than often vowels are removed from the words. Examples would be, *do not* to *don't* and *I would* to *I'd*. Contractions pose a problem in text normalization because we have to deal with special characters like the apostrophe and we also have to convert each contraction to its expanded, original form. Our `expand_contractions(...)` function uses regular expressions and various contractions mapped in our `contractions.py` module to expand all contractions in our text corpus.
- **Removing special characters:** Another important task in text cleaning and normalization is to remove special characters and symbols that often add to the extra noise in unstructured text. Simple regexes can be used to achieve this. Our function `remove_special_characters(...)` helps us remove special characters. In our code, we have retained numbers but you can also remove numbers if you do not want them in your normalized corpus.

- **Stemming and lemmatization:** Word stems are usually the base form of possible words that can be created by attaching affixes like prefixes and suffixes to the stem to create new words. This is known as inflection. The reverse process of obtaining the base form of a word is known as stemming. A simple example are the words **WATCHES**, **WATCHING**, and **WATCHED**. They have the word root stem **WATCH** as the base form. The `nltk` package offers a wide range of stemmers like the `PorterStemmer` and `LancasterStemmer`. Lemmatization is very similar to stemming, where we remove word affixes to get to the base form of a word. However the base form in this case is known as the root word but not the root stem. The difference being that the root word is always a lexicographically correct word (present in the dictionary) but the root stem may not be so. We will be using lemmatization only in our normalization pipeline to retain lexicographically correct words. The function `lemmatize_text(...)` helps us with this aspect.
- **Removing stopwords:** Words which have little or no significance especially when constructing meaningful features from text are also known as stopwords or stop words. These are usually words that end up having the maximum frequency if you do a simple term or word frequency in a document corpus. Words like *a*, *an*, *the*, and so on are considered to be stopwords. There is no universal stopwords list but we use a standard English language stopwords list from `nltk`. You can also add your own domain specific stopwords if needed. The function `remove_stopwords(...)` helps us remove stopwords and retain words having the most significance and context in a corpus.

We use all these components and tie them together in the following function called `normalize_corpus(...)`, which can be used to take a document corpus as input and return the same corpus with cleaned and normalized text documents.

```
def normalize_corpus(corpus, html_stripping=True, contraction_expansion=True,
                    accented_char_removal=True, text_lower_case=True,
                    text_lemmatization=True, special_char_removal=True,
                    stopwords_removal=True):
    normalized_corpus = []
    # normalize each document in the corpus
    for doc in corpus:
        # strip HTML
        if html_stripping:
            doc = strip_html_tags(doc)
        # remove accented characters
        if accented_char_removal:
            doc = remove_accented_chars(doc)
        # expand contractions
        if contraction_expansion:
            doc = expand_contractions(doc)
        # lowercase the text
        if text_lower_case:
            doc = doc.lower()
        # remove extra newlines
        doc = re.sub(r'[\r|\n|\r\n]+', ' ', doc)
        # insert spaces between special characters to isolate them
        special_char_pattern = re.compile(r'([{-!}])')
        doc = special_char_pattern.sub(" \\1 ", doc)
```

```

# lemmatize text
if text_lemmatization:
    doc = lemmatize_text(doc)
# remove special characters
if special_char_removal:
    doc = remove_special_characters(doc)
# remove extra whitespace
doc = re.sub(' +', ' ', doc)
# remove stopwords
if stopword_removal:
    doc = remove_stopwords(doc, is_lower_case=text_lower_case)

normalized_corpus.append(doc)

return normalized_corpus

```

The following snippet depicts a small demo of text normalization on a sample document using our normalization module.

```
In [1]: from text_normalizer import normalize_corpus
```

```
In [2]: document = """<p>Hélllo! Hélllo! can you hear me! I just heard about <b>Python</b>
<br/>\r\n
...: It's an amazing language which can be used for Scripting, Web development,\r\n\r\n
...: Information Retrieval, Natural Language Processing, Machine Learning & Artificial
Intelligence!\n
...: What are you waiting for? Go and get started.<br/> He's learning, she's learning,
they've already\n\n
...: got a headstart!</p>
...: """
```

```
In [3]: document
```

```
Out[3]: "<p>Hélllo! Hélllo! can you hear me! I just heard about <b>Python</b>!\n
\r\n          It's an amazing language which can be used for Scripting, Web development,
\r\n\r\n          Information Retrieval, Natural Language Processing, Machine
Learning & Artificial Intelligence!\n\n          What are you waiting for? Go and
get started.<br/> He's learning, she's learning, they've already\n\n          got a
headstart!</p>\n          "
```

```
In [4]: normalize_corpus([document], text_lemmatization=False, stopword_removal=False,
text_lower_case=False)
```

```
Out[4]: ['Hello Hello can you hear me I just heard about Python It is an amazing language
which can be used for Scripting Web development Information Retrieval Natural Language
Processing Machine Learning Artificial Intelligence What are you waiting for Go and get
started He is learning she is learning they have already got a headstart ']
```

```
In [5]: normalize_corpus([document])
```

```
Out[5]: ['hello hello hear hear python amazing language use scripting web development
information retrieval natural language processing machine learning artificial intelligence
wait go get start learn already get headstart']
```



Now that we have our normalization module ready, we can start modeling and analyzing our corpus. NLP and text analytics enthusiasts who might be interested in more in-depth details of text normalization can refer to the section “Text Normalization,” Chapter 3, page 115, of *Text Analytics with Python* (Apress; Dipanjan Sarkar, 2016).

## Unsupervised Lexicon-Based Models

We have talked about unsupervised learning methods in the past, which refer to specific modeling methods that can be applied directly on data features without the presence of labeled data. One of the major challenges in any organization is getting labeled datasets due the lack of time as well as resources to do this tedious task. Unsupervised methods are very useful in this scenario and we will be looking at some of these methods in this section. Even though we have labeled data, this section should give you a good idea of how lexicon based models work and you can apply the same in your own datasets when you do not have labeled data.

Unsupervised sentiment analysis models use well curated knowledgebases, ontologies, lexicons, and databases that have detailed information pertaining to subjective words, phrases including sentiment, mood, polarity, objectivity, subjectivity, and so on. A lexicon model typically uses a lexicon, also known as a dictionary or vocabulary of words specifically aligned toward sentiment analysis. Usually these lexicons contain a list of words associated with positive and negative sentiment, polarity (magnitude of negative or positive score), parts of speech (POS) tags, subjectivity classifiers (strong, weak, neutral), mood, modality, and so on. You can use these lexicons and compute sentiment of a text document by matching the presence of specific words from the lexicon, look at other additional factors like presence of negation parameters, surrounding words, overall context and phrases and aggregate overall sentiment polarity scores to decide the final sentiment score. There are several popular lexicon models used for sentiment analysis. Some of them are mentioned as follows.

- Bing Liu’s Lexicon
- MPQA Subjectivity Lexicon
- Pattern Lexicon
- AFINN Lexicon
- SentiWordNet Lexicon
- VADER Lexicon

This is not an exhaustive list of lexicon models, but definitely lists among the most popular ones available today. We will be covering the last three lexicon models in more detail with hands-on code and examples using our movie review dataset. We will be using the last 15,000 reviews and predict their sentiment and see how well our model performs based on model evaluation metrics like accuracy, precision, recall, and F1-score, which we covered in detail in Chapter 5. Since we have labeled data, it will be easy for us to see how well our actual sentiment values for these movie reviews match our lexicon-model based predicted sentiment values. You can refer to the Python file titled `unsupervised_sentiment_analysis.py` for all the code used in this section or use the jupyter notebook titled `Sentiment Analysis - Unsupervised Lexical.ipynb` for a more interactive experience. Before we start our analysis, let’s load the necessary dependencies and configuration settings using the following snippet.

```
In [1]: import pandas as pd
...: import numpy as np
...: import text_normalizer as tn
...: import model_evaluation_utils as meu
...:
...: np.set_printoptions(precision=2, linewidth=80)
```

Now, we can load our IMDb review dataset, subset out the last 15,000 reviews which will be used for our analysis, and normalize them using the following snippet.

```
In [2]: dataset = pd.read_csv(r'movie_reviews.csv')
...:
...: reviews = np.array(dataset['review'])
...: sentiments = np.array(dataset['sentiment'])
...:
...: # extract data for model evaluation
...: test_reviews = reviews[35000:]
...: test_sentiments = sentiments[35000:]
...: sample_review_ids = [7626, 3533, 13010]
...:
...: # normalize dataset
...: norm_test_reviews = tn.normalize_corpus(test_reviews)
```

We also extract out some sample reviews so that we can run our models on them and interpret their results in detail.

## Bing Liu’s Lexicon

This lexicon contains over 6,800 words which have been divided into two files named `positive-words.txt`, containing around 2,000+ words/phrases and `negative-words.txt`, which contains 4,800+ words/phrases. The lexicon has been developed and curated by Bing Liu over several years and has also been explained in detail in his original paper by Nitin Jindal and Bing Liu, “Identifying Comparative Sentences in Text Documents” proceedings of the 29th Annual International ACM SIGIR, Seattle 2006. If you want to use this lexicon, you can get it from <https://www.cs.uic.edu/~liub/FBS/sentiment-analysis.html#lexicon>, which also includes a link to download it as an archive (RAR format).

## MPQA Subjectivity Lexicon

The term MPQA stands for Multi-Perspective Question Answering and it contains a diverse set of resources pertaining to opinion corpora, subjectivity lexicon, subjectivity sense annotations, argument lexicon, debate corpora, opinion finder, and many more. This is developed and maintained by the University of Pittsburgh and their official web site <http://mpqa.cs.pitt.edu/> contains all the necessary information. The subjectivity lexicon is a part of their opinion finder framework and contains subjectivity clues and contextual polarity. Details on this can be found in the paper by Theresa Wilson, Janyce Wiebe, and Paul Hoffmann, “Recognizing Contextual Polarity in Phrase-Level Sentiment Analysis” proceeding of HLT-EMNLP-2005.

You can download the subjectivity lexicon from their official web site at [http://mpqa.cs.pitt.edu/lexicons/subj\\_lexicon/](http://mpqa.cs.pitt.edu/lexicons/subj_lexicon/), contains subjectivity clues present in the dataset named `subjclueslen1-HLTEMNLP05.tff`. The following snippet shows some sample lines from the lexicon.

```
type=weaksubj len=1 word1=abandonment pos1=noun stemmed1=n priorpolarity=negative
type=weaksubj len=1 word1=abandon pos1=verb stemmed1=y priorpolarity=negative
...
...
type=strongsubj len=1 word1=zenith pos1=noun stemmed1=n priorpolarity=positive
type=strongsubj len=1 word1=zest pos1=noun stemmed1=n priorpolarity=positive
```

Each line consists of a specific word and its associated polarity, POS tag information, length (right now only words of length 1 are present), subjective context, and stem information.

## Pattern Lexicon

The pattern package is a complete natural language processing framework available in Python which can be used for text processing, sentiment analysis and more. This has been developed by CLiPS (Computational Linguistics & Psycholinguistics), a research center associated with the Linguistics Department of the Faculty of Arts of the University of Antwerp. Pattern uses its own sentiment module which internally uses a lexicon which you can access from their official GitHub repository at <https://github.com/clips/pattern/blob/master/pattern/text/en/en-sentiment.xml> and this contains the complete subjectivity based lexicon database. Each line in the lexicon typically looks like the following sample.

```
<word form="absurd" wordnet_id="a-02570643" pos="JJ" sense="incongruous" polarity="-0.5"
subjectivity="1.0" intensity="1.0" confidence="0.9" />
```

Thus you get important metadata information like WordNet corpus identifiers, polarity scores, word sense, POS tags, intensity, subjectivity scores, and so on. These can in turn be used to compute sentiment over a text document based on polarity and subjectivity score. Unfortunately, pattern has still not been ported officially for Python 3.x and it works on Python 2.7.x. However, you can still load this lexicon and do your own modeling as needed.

## AFINN Lexicon

The AFINN lexicon is perhaps one of the simplest and most popular lexicons that can be used extensively for sentiment analysis. Developed and curated by Finn Årup Nielsen, you can find more details on this lexicon in the paper by Finn Årup Nielsen, “A new ANEW: evaluation of a word list for sentiment analysis in microblogs”, proceedings of the ESWC2011 Workshop. The current version of the lexicon is AFINN-en-165.txt and it contains over 3,300+ words with a polarity score associated with each word. You can find this lexicon at the author’s official GitHub repository along with previous versions of this lexicon including AFINN-111 at <https://github.com/fnielsen/afinn/blob/master/afinn/data/>. The author has also created a nice wrapper library on top of this in Python called `afinn` which we will be using for our analysis needs. You can import the library and instantiate an object using the following code.

```
In [3]: from afinn import Afinn
...:
...: afn = Afinn(emoticons=True)
```

We can now use this object and compute the polarity of our chosen four sample reviews using the following snippet.

```
In [4]: for review, sentiment in zip(test_reviews[sample_review_ids], test_
sentiments[sample_review_ids]):
...:     print('REVIEW:', review)
...:     print('Actual Sentiment:', sentiment)
...:     print('Predicted Sentiment polarity:', afn.score(review))
...:     print('-'*60)
REVIEW: no comment - stupid movie, acting average or worse... screenplay - no sense at
all... SKIP IT!
Actual Sentiment: negative
```

```
Predicted Sentiment polarity: -7.0
```

```
-----
REVIEW: I don't care if some people voted this movie to be bad. If you want the Truth this
is a Very Good Movie! It has every thing a movie should have. You really should Get this
one.
```

```
Actual Sentiment: positive
```

```
Predicted Sentiment polarity: 3.0
```

```
-----
REVIEW: Worst horror film ever but funniest film ever rolled in one you have got to see this
film it is so cheap it is unbelievable but you have to see it really!!!! P.S. Watch the
carrot
```

```
Actual Sentiment: positive
```

```
Predicted Sentiment polarity: -3.0
```

We can compare the actual sentiment label for each review and also check out the predicted sentiment polarity score. A negative polarity typically denotes negative sentiment. To predict sentiment on our complete test dataset of 15,000 reviews (I used the raw text documents because AFINN takes into account other aspects like emoticons and exclamations), we can now use the following snippet. I used a threshold of  $\geq 1.0$  to determine if the overall sentiment is positive else negative. You can choose your own threshold based on analyzing your own corpora in the future.

```
In [5]: sentiment_polarity = [afn.score(review) for review in test_reviews]
...: predicted_sentiments = ['positive' if score >= 1.0 else 'negative' for score in
                             sentiment_polarity]
```

Now that we have our predicted sentiment labels, we can evaluate our model performance based on standard performance metrics using our utility function. See Figure 7-1.

```
In [6]: meu.display_model_performance_metrics(true_labels=test_sentiments,
                                             predicted_labels=predicted_sentiments,
                                             classes=['positive', 'negative'])
```

Model Performance metrics:	Model Classification report:					Prediction Confusion Matrix:		
Accuracy: 0.71		precision	recall	f1-score	support		Predicted:	
Precision: 0.73						Actual: positive	positive	negative
Recall: 0.71	positive	0.67	0.85	0.75	7510		6376	1134
F1 Score: 0.71	negative	0.79	0.57	0.67	7490	negative	3189	4301
	avg / total	0.73	0.71	0.71	15000			

**Figure 7-1.** Model performance metrics for AFINN lexicon based model

We get an overall **F1-Score** of 71%, which is quite decent considering it's an unsupervised model. Looking at the confusion matrix we can clearly see that quite a number of negative sentiment based reviews have been misclassified as positive (3,189) and this leads to the lower recall of 57% for the negative sentiment class. Performance for positive class is better with regard to recall or hit-rate, where we correctly predicted 6,376 out of 7,510 positive reviews, but precision is 67% because of the many wrong positive predictions made in case of negative sentiment reviews.

## SentiWordNet Lexicon

The WordNet corpus is definitely one of the most popular corpora for the English language used extensively in natural language processing and semantic analysis. WordNet gave us the concept of synsets or synonym sets. The SentiWordNet lexicon is based on WordNet synsets and can be used for sentiment analysis and opinion mining. The SentiWordNet lexicon typically assigns three sentiment scores for each WordNet synset. These include a positive polarity score, a negative polarity score and an objectivity score. Further details are available on the official web site <http://sentiwordnet.isti.cnr.it>, including research papers and download links for the lexicon. We will be using the nltk library, which provides a Pythonic interface into SentiWordNet. Consider we have the adjective *awesome*. We can get the sentiment scores associated with the synset for this word using the following snippet.

```
In [8]: from nltk.corpus import sentiwordnet as swn
...:
...: awesome = list(swn.senti_synsets('awesome', 'a'))[0]
...: print('Positive Polarity Score:', awesome.pos_score())
...: print('Negative Polarity Score:', awesome.neg_score())
...: print('Objective Score:', awesome.obj_score())
Positive Polarity Score: 0.875
Negative Polarity Score: 0.125
Objective Score: 0.0
```

Let's now build a generic function to extract and aggregate sentiment scores for a complete textual document based on matched synsets in that document.

```
def analyze_sentiment_sentiwordnet_lexicon(review,
                                         verbose=False):

    # tokenize and POS tag text tokens
    tagged_text = [(token.text, token.tag_) for token in tn.nlp(review)]
    pos_score = neg_score = token_count = obj_score = 0
    # get wordnet synsets based on POS tags
    # get sentiment scores if synsets are found
    for word, tag in tagged_text:
        ss_set = None
        if 'NN' in tag and list(swn.senti_synsets(word, 'n')):
            ss_set = list(swn.senti_synsets(word, 'n'))[0]
        elif 'VB' in tag and list(swn.senti_synsets(word, 'v')):
            ss_set = list(swn.senti_synsets(word, 'v'))[0]
        elif 'JJ' in tag and list(swn.senti_synsets(word, 'a')):
            ss_set = list(swn.senti_synsets(word, 'a'))[0]
        elif 'RB' in tag and list(swn.senti_synsets(word, 'r')):
            ss_set = list(swn.senti_synsets(word, 'r'))[0]
        # if senti-synset is found
        if ss_set:
            # add scores for all found synsets
            pos_score += ss_set.pos_score()
            neg_score += ss_set.neg_score()
            obj_score += ss_set.obj_score()
            token_count += 1
```

```

# aggregate final scores
final_score = pos_score - neg_score
norm_final_score = round(float(final_score) / token_count, 2)
final_sentiment = 'positive' if norm_final_score >= 0 else 'negative'
if verbose:
    norm_obj_score = round(float(obj_score) / token_count, 2)
    norm_pos_score = round(float(pos_score) / token_count, 2)
    norm_neg_score = round(float(neg_score) / token_count, 2)
    # to display results in a nice table
    sentiment_frame = pd.DataFrame([[final_sentiment, norm_obj_score, norm_pos_score,
                                     norm_neg_score, norm_final_score]],
                                   columns=pd.MultiIndex(levels=[['SENTIMENT STATS:'],
                                                                ['Predicted Sentiment',
                                                                 'Objectivity',
                                                                 'Positive', 'Negative',
                                                                 'Overall']],
                                                         labels=[[0,0,0,0,0],[0,1,2,3,4]]))

    print(sentiment_frame)
return final_sentiment

```

Our function basically takes in a movie review, tags each word with its corresponding POS tag, extracts out sentiment scores for any matched synset token based on its POS tag, and finally aggregates the scores. This will be clearer when we run it on our sample documents.

```
In [10]: for review, sentiment in zip(test_reviews[sample_review_ids], test_
sentiments[sample_review_ids]):
```

```

...:     print('REVIEW:', review)
...:     print('Actual Sentiment:', sentiment)
...:     pred = analyze_sentiment_sentiwordnet_lexicon(review, verbose=True)
...:     print('-'*60)

```

```
REVIEW: no comment - stupid movie, acting average or worse... screenplay - no sense at
all... SKIP IT!
```

```
Actual Sentiment: negative
```

```
SENTIMENT STATS:
```

	Predicted Sentiment	Objectivity	Positive	Negative	Overall
0	negative	0.76	0.09	0.15	-0.06

```
REVIEW: I don't care if some people voted this movie to be bad. If you want the Truth this
is a Very Good Movie! It has every thing a movie should have. You really should Get this
one.
```

```
Actual Sentiment: positive
```

```
SENTIMENT STATS:
```

	Predicted Sentiment	Objectivity	Positive	Negative	Overall
0	positive	0.74	0.2	0.06	0.14

```
REVIEW: Worst horror film ever but funniest film ever rolled in one you have got to see this
film it is so cheap it is unbelievable but you have to see it really!!!! P.S. watch the
carrot
```

Actual Sentiment: positive

SENTIMENT STATS:

Predicted Sentiment	Objectivity	Positive	Negative	Overall
0	positive	0.8	0.14	0.07

-----

We can clearly see the predicted sentiment along with sentiment polarity scores and an objectivity score for each sample movie review depicted in formatted dataframes. Let's use this model now to predict the sentiment of all our test reviews and evaluate its performance. A threshold of  $\geq 0$  has been used for the overall sentiment polarity to be classified as positive and  $< 0$  for negative sentiment. See Figure 7-2.

```
In [11]: predicted_sentiments = [analyze_sentiment_sentiwordnet_lexicon(review,
verbose=False)
                                     for review in norm_test_reviews]
...: meu.display_model_performance_metrics(true_labels=test_sentiments,
predicted_labels=predicted_sentiments,
classes=['positive', 'negative'])
```

Model Performance metrics:	Model Classification report:				Prediction Confusion Matrix:		
Accuracy: 0.69							
Precision: 0.69		precision	recall	f1-score	support		
Recall: 0.69	positive	0.66	0.76	0.71	7510	Actual: positive	5742 1768
F1 Score: 0.68	negative	0.72	0.61	0.66	7490	negative	2932 4558
	avg / total	0.69	0.69	0.68	15000		

Figure 7-2. Model performance metrics for SentiWordNet lexicon based model

We get an overall **F1-Score** of **68%**, which is definitely a step down from our AFINN based model. While we have lesser number of negative sentiment based reviews being misclassified as positive, the other aspects of the model performance have been affected.

## VADER Lexicon

The VADER lexicon, developed by C.J. Hutto, is a lexicon that is based on a rule-based sentiment analysis framework, specifically tuned to analyze sentiments in social media. VADER stands for Valence Aware Dictionary and Sentiment Reasoner. Details about this framework can be read in the original paper by Hutto, C.J. & Gilbert, E.E. (2014) titled "VADER: A Parsimonious Rule-based Model for Sentiment Analysis of Social Media Text", proceedings of the Eighth International Conference on Weblogs and Social Media (ICWSM-14). You can use the library based on nltk's interface under the `nltk.sentiment.vader` module. Besides this, you can also download the actual lexicon or install the framework from <https://github.com/cjhutto/vaderSentiment>, which also contains detailed information about VADER. This lexicon, present in the file titled `vader_lexicon.txt` contains necessary sentiment scores associated with words, emoticons and slangs (like *wtf*, *lol*, *nah*, and so on). There were a total of over 9000 lexical features from which over 7500 curated lexical features were finally selected in the lexicon with proper validated valence scores. Each feature was rated on a scale from "[ -4] Extremely Negative" to "[ 4] Extremely Positive", with allowance for "[ 0] Neutral (or Neither, N/A)". The process of selecting lexical features was done by keeping all features that had a non-zero mean rating and whose standard deviation was less than 2.5, which was determined by the aggregate of ten independent raters. We depict a sample from the VADER lexicon as follows.

```
:(      -1.9      1.13578 [-2, -3, -2, 0, -1, -1, -2, -3, -1, -4]
:)      2.0      1.18322 [2, 2, 1, 1, 1, 1, 4, 3, 4, 1]
...
terrorizing      -3.0      1.0      [-3, -1, -4, -4, -4, -3, -2, -3, -2, -4]
thankful         2.7      0.78102 [4, 2, 2, 3, 2, 4, 3, 3, 2, 2]
```

Each line in the preceding lexicon sample depicts a unique term, which can either be an emoticon or a word. The first token indicates the word/emoticon, the second token indicates the mean sentiment polarity score, the third token indicates the standard deviation, and the final token indicates a list of scores given by ten independent scorers. Now let's use VADER to analyze our movie reviews! We build our own modeling function as follows.

```
from nltk.sentiment.vader import SentimentIntensityAnalyzer

def analyze_sentiment_vader_lexicon(review,
                                    threshold=0.1,
                                    verbose=False):
    # pre-process text
    review = tn.strip_html_tags(review)
    review = tn.remove_accented_chars(review)
    review = tn.expand_contractions(review)

    # analyze the sentiment for review
    analyzer = SentimentIntensityAnalyzer()
    scores = analyzer.polarity_scores(review)
    # get aggregate scores and final sentiment
    agg_score = scores['compound']
    final_sentiment = 'positive' if agg_score >= threshold
                    else 'negative'

    if verbose:
        # display detailed sentiment statistics
        positive = str(round(scores['pos'], 2)*100)+'%'
        final = round(agg_score, 2)
        negative = str(round(scores['neg'], 2)*100)+'%'
        neutral = str(round(scores['neu'], 2)*100)+'%'
        sentiment_frame = pd.DataFrame([[final_sentiment, final, positive,
                                         negative, neutral]],
                                       columns=pd.MultiIndex(levels=[['SENTIMENT STATS:'],
                                                                    ['Predicted Sentiment', 'Polarity Score',
                                                                    'Positive', 'Negative', 'Neutral']],
                                                             labels=[[0,0,0,0,0],[0,1,2,3,4]]))

        print(sentiment_frame)

    return final_sentiment
```

In our modeling function, we do some basic pre-processing but keep the punctuations and emoticons intact. Besides this, we use VADER to get the sentiment polarity and also proportion of the review text with regard to positive, neutral and negative sentiment. We also predict the final sentiment based on a user-input threshold for the aggregated sentiment polarity. Typically, VADER recommends using positive sentiment



for aggregated polarity  $\geq 0.5$ , *neutral* between  $[-0.5, 0.5]$ , and *negative* for polarity  $< -0.5$ . We use a threshold of  $\geq 0.4$  for positive and  $\leq -0.4$  for negative in our corpus. The following is the analysis of our sample reviews.

```
In [13]: for review, sentiment in zip(test_reviews[sample_review_ids], test_
sentiments[sample_review_ids]):
...:     print('REVIEW:', review)
...:     print('Actual Sentiment:', sentiment)
...:     pred = analyze_sentiment_vader_lexicon(review, threshold=0.4, verbose=True)
...:     print('-'*60)
```

REVIEW: no comment - stupid movie, acting average or worse... screenplay - no sense at all... SKIP IT!

Actual Sentiment: negative

SENTIMENT STATS:

Predicted	Sentiment	Polarity	Score	Positive	Negative	Neutral
0	negative	-0.8	0.0%	40.0%	60.0%	

REVIEW: I don't care if some people voted this movie to be bad. If you want the Truth this is a Very Good Movie! It has every thing a movie should have. You really should Get this one.

Actual Sentiment: positive

SENTIMENT STATS:

Predicted	Sentiment	Polarity	Score	Positive	Negative	Neutral
0	negative	-0.16	16.0%	14.0%	69.0%	

REVIEW: Worst horror film ever but funniest film ever rolled in one you have got to see this film it is so cheap it is unbelievable but you have to see it really!!!! P.S. Watch the carrot

Actual Sentiment: positive

SENTIMENT STATS:

Predicted	Sentiment	Polarity	Score	Positive	Negative	Neutral
0	positive	0.49	11.0%	11.0%	77.0%	

We can see the details statistics pertaining to the sentiment and polarity for each sample movie review. Let's try out our model on the complete test movie review corpus now and evaluate the model performance. See Figure 7-3.

```
In [14]: predicted_sentiments = [analyze_sentiment_vader_lexicon(review, threshold=0.4,
...:                                                                verbose=False) for review in test_
reviews]
...: meu.display_model_performance_metrics(true_labels=test_sentiments,
...:                                     predicted_labels=predicted_sentiments,
...:                                     classes=['positive', 'negative'])
```

Model Performance metrics:	Model Classification report:				Prediction Confusion Matrix:	
Accuracy: 0.71 Precision: 0.72 Recall: 0.71 F1 Score: 0.71		precision	recall	f1-score	support	
	positive	0.67	0.83	0.74	7510	Actual: positive 6235 1275
	negative	0.78	0.59	0.67	7490	negative 3068 4422
	avg / total	0.72	0.71	0.71	15000	

Figure 7-3. Model performance metrics for VADER lexicon based model

We get an overall **F1-Score** and model **accuracy** of **71%**, which is quite similar to the AFINN based model. The AFINN based model only wins out on the average precision by 1%; otherwise, both models have a similar performance.

## Classifying Sentiment with Supervised Learning

Another way to build a model to understand the text content and predict the sentiment of the text based reviews is to use supervised Machine Learning. To be more specific, we will be using classification models for solving this problem. We have already covered the concepts relevant to supervised learning and classification in Chapter 1 under the section “Supervised Learning”. With regard to details on building and evaluating classification models, you can head over to Chapter 5 and refresh your memory if needed. We will be building an automated sentiment text classification system in subsequent sections. The major steps to achieve this are mentioned as follows.

1. Prepare train and test datasets (optionally a validation dataset)
2. Pre-process and normalize text documents
3. Feature engineering
4. Model training
5. Model prediction and evaluation

These are the major steps for building our system. Optionally the last step would be to deploy the model in your server or on the cloud. Figure 7-4 shows a detailed workflow for building a standard text classification system with supervised learning (classification) models.

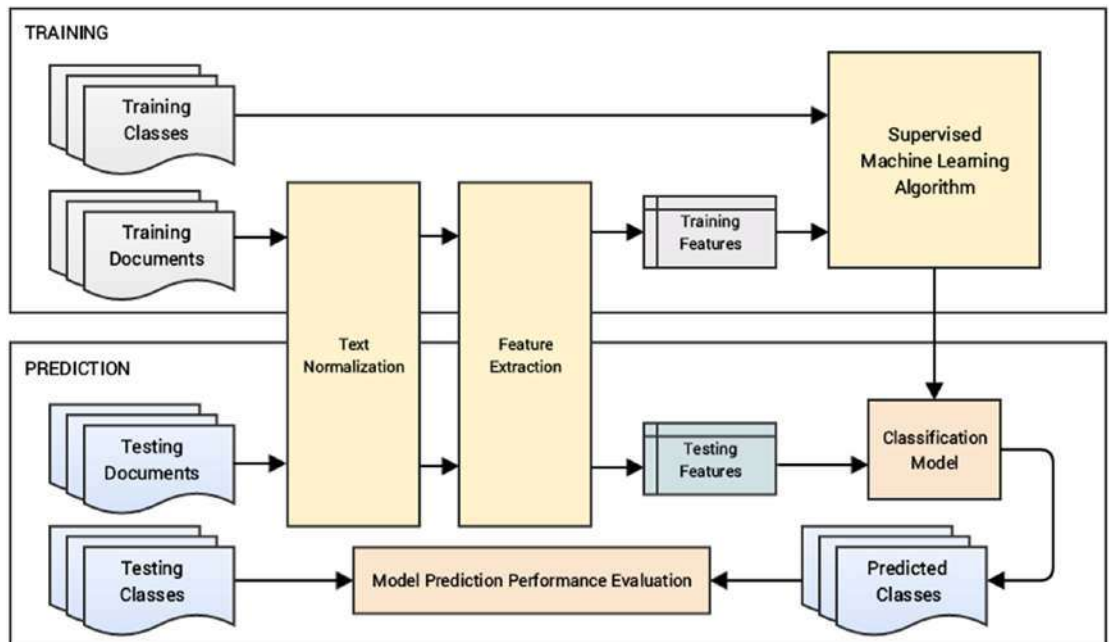

**Figure 7-4.** Blueprint for building an automated text classification system (Source: *Text Analytics with Python*, Apress 2016)

In our scenario, documents indicate the movie reviews and classes indicate the review sentiments that can either be positive or negative, making it a binary classification problem. We will build models using both traditional Machine Learning methods and newer Deep Learning in the subsequent sections. You can refer to the Python file titled `supervised_sentiment_analysis.py` for all the code used in this section or use the jupyter notebook titled `Sentiment Analysis - Supervised.ipynb` for a more interactive experience. Let's load the necessary dependencies and settings before getting started.

```
In [1]: import pandas as pd
...: import numpy as np
...: import text_normalizer as tn
...: import model_evaluation_utils as meu
...:
...: np.set_printoptions(precision=2, linewidth=80)
```

We can now load our IMDb movie reviews dataset, use the first 35,000 reviews for training models and the remaining 15,000 reviews as the test dataset to evaluate model performance. Besides this, we will also use our normalization module to normalize our review datasets (Steps 1 and 2 in our workflow).

```
In [2]: dataset = pd.read_csv(r'movie_reviews.csv')
...:
...: # take a peek at the data
...: print(dataset.head())
...: reviews = np.array(dataset['review'])
...: sentiments = np.array(dataset['sentiment'])
...:
...: # build train and test datasets
...: train_reviews = reviews[:35000]
...: train_sentiments = sentiments[:35000]
...: test_reviews = reviews[35000:]
...: test_sentiments = sentiments[35000:]
...:
...: # normalize datasets
...: norm_train_reviews = tn.normalize_corpus(train_reviews)
...: norm_test_reviews = tn.normalize_corpus(test_reviews)
...:
...: review sentiment
0 One of the other reviewers has mentioned that ... positive
1 A wonderful little production. <br /><br />The... positive
2 I thought this was a wonderful way to spend ti... positive
3 Basically there's a family where a little boy ... negative
4 Petter Mattei's "Love in the Time of Money" is... positive
```

Our datasets are now prepared and normalized so we can proceed from Step 3 in our text classification workflow described earlier to build our classification system.

## Traditional Supervised Machine Learning Models

We will be using traditional classification models in this section to classify the sentiment of our movie reviews. Our **feature engineering** techniques (Step 3) will be based on the Bag of Words model and the TF-IDF model, which we discussed extensively in the section titled “Feature Engineering on Text Data” in Chapter 4. The following snippet helps us engineer features using both these models on our train and test datasets.

```
In [3]: from sklearn.feature_extraction.text import CountVectorizer, TfidfVectorizer
...:
...: # build BOW features on train reviews
...: cv = CountVectorizer(binary=False, min_df=0.0, max_df=1.0, ngram_range=(1,2))
...: cv_train_features = cv.fit_transform(norm_train_reviews)
...: # build TFIDF features on train reviews
...: tv = TfidfVectorizer(use_idf=True, min_df=0.0, max_df=1.0, ngram_range=(1,2),
...:                       sublinear_tf=True)
...: tv_train_features = tv.fit_transform(norm_train_reviews)
...:
...: # transform test reviews into features
...: cv_test_features = cv.transform(norm_test_reviews)
...: tv_test_features = tv.transform(norm_test_reviews)
...:
...: print('BOW model:> Train features shape:', cv_train_features.shape,
...:       ' Test features shape:', cv_test_features.shape)
...: print('TFIDF model:> Train features shape:', tv_train_features.shape,
...:       ' Test features shape:', tv_test_features.shape)
```

```
BOW model:> Train features shape: (35000, 2114021) Test features shape: (15000, 2114021)
TFIDF model:> Train features shape: (35000, 2114021) Test features shape: (15000, 2114021)
```

We take into account word as well as bi-grams for our feature-sets. We can now use some traditional supervised Machine Learning algorithms which work very well on text classification. We recommend using logistic regression, support vector machines, and multinomial Naïve Bayes models when you work on your own datasets in the future. In this chapter, we built models using Logistic Regression as well as SVM. The following snippet helps initialize these classification model estimators.

```
In [4]: from sklearn.linear_model import SGDClassifier, LogisticRegression
...:
...: lr = LogisticRegression(penalty='l2', max_iter=100, C=1)
...: svm = SGDClassifier(loss='hinge', n_iter=100)
```

Without going into too many theoretical complexities, the logistic regression model is a supervised linear Machine Learning model used for classification regardless of its name. In this model, we try to predict the probability that a given movie review will belong to one of the discrete classes (binary classes in our scenario). The function used by the model for learning is represented here.

$$P(y = \textit{positive}|X) = \sigma(\theta^T X)$$

$$P(y = \textit{negative}|X) = 1 - \sigma(\theta^T X)$$

Where the model tries to predict the sentiment class using the feature vector  $X$  and  $\sigma(z) = \frac{1}{1 + e^{-z}}$ , which is popularly known as the sigmoid function or logistic function or the logit function. The main objective of this model is to search for an optimal value of  $\theta$  such that probability of the positive sentiment class is maximum when the feature vector  $X$  is for a positive movie review and small when it is for a negative movie review. The logistic function helps model the probability to describe the final prediction class. The optimal value of  $\theta$  can be obtained by minimizing an appropriate cost/loss function using standard methods like

gradient descent (refer to the section, “The Three Stages of Logistic Regression” in Chapter 5 if you are interested in more details). Logistic regression is also popularly known as logit regression or MaxEnt (maximum entropy) classifier.

We will now use our utility function `train_predict_model(...)` from our `model_evaluation_utils` module to build a logistic regression model on our training features and evaluate the model performance on our test features (Steps 4 and 5). See Figure 7-5.

```
In [5]: # Logistic Regression model on BOW features
...: lr_bow_predictions = meu.train_predict_model(classifier=lr,
...:                                             train_features=cv_train_features, train_labels=train_
...:                                             sentiments,
...:                                             test_features=cv_test_features, test_labels=test_sentiments)
...: meu.display_model_performance_metrics(true_labels=test_sentiments,
...:                                     predicted_labels=lr_bow_predictions,
...:                                     classes=['positive', 'negative'])
```

Model Performance metrics:	Model Classification report:				Prediction Confusion Matrix:			
Accuracy: 0.91								
Precision: 0.91		precision	recall	f1-score	support		Predicted:	
Recall: 0.91						Actual: positive	positive	negative
F1 Score: 0.91	positive	0.90	0.91	0.91	7510	negative	6817	693
	negative	0.91	0.90	0.90	7490		731	6759
	avg / total	0.91	0.91	0.91	15000			

**Figure 7-5.** Model performance metrics for logistic regression on Bag of Words features

We get an overall **F1-Score** and model **accuracy** of **91%**, as depicted in Figure 7-5, which is really excellent! We can now build a logistic regression model similarly on our TF-IDF features using the following snippet. See Figure 7-6.

```
In [6]: # Logistic Regression model on TF-IDF features
...: lr_tfidf_predictions = meu.train_predict_model(classifier=lr,
...:                                             train_features=tv_train_features, train_labels=train_
...:                                             sentiments,
...:                                             test_features=tv_test_features, test_labels=test_sentiments)
...: meu.display_model_performance_metrics(true_labels=test_sentiments,
...:                                     predicted_labels=lr_tfidf_predictions,
...:                                     classes=['positive', 'negative'])
```

Model Performance metrics:	Model Classification report:				Prediction Confusion Matrix:			
Accuracy: 0.9								
Precision: 0.9		precision	recall	f1-score	support		Predicted:	
Recall: 0.9						Actual: positive	positive	negative
F1 Score: 0.9	positive	0.89	0.90	0.90	7510	negative	6780	730
	negative	0.90	0.89	0.90	7490		828	6662
	avg / total	0.90	0.90	0.90	15000			

**Figure 7-6.** Model performance metrics for logistic regression on TF-IDF features

We get an overall **F1-Score** and model **accuracy** of **90%**, depicted in Figure 7-6, which is great but our previous model is still slightly better. You can similarly use the Support Vector Machine model estimator object `svm`, which we created earlier, and use the same snippet to train and predict using an SVM model. We obtained a maximum **accuracy** and **F1-score** of **90%** with the SVM model (refer to the jupyter notebook for step-by-step code snippets). Thus you can see how effective and accurate these supervised Machine Learning classification algorithms are in building a text sentiment classifier.

## Newer Supervised Deep Learning Models

We have already mentioned multiple times in previous chapters about how Deep Learning has revolutionized the Machine Learning landscape over the last decade. In this section, we will be building some deep neural networks and train them on some advanced text features based on word embeddings to build a text sentiment classification system similar to what we did in the previous section. Let's load the following necessary dependencies before we start our analysis.

```
In [7]: import gensim
...: import keras
...: from keras.models import Sequential
...: from keras.layers import Dropout, Activation, Dense
...: from sklearn.preprocessing import LabelEncoder
Using TensorFlow backend.
```

If you remember in Chapter 4, we talked about encoding categorical class labels and also the one-hot encoding scheme. So far, our models in `scikit-learn` directly accepted the sentiment class labels as positive and negative and internally performed these operations. However for our Deep Learning models, we need to do this explicitly. The following snippet helps us tokenize our movie reviews and also converts the text-based sentiment class labels into one-hot encoded vectors (forms a part of Step 2).

```
In [8]: le = LabelEncoder()
...: num_classes=2
...: # tokenize train reviews & encode train labels
...: tokenized_train = [tn.tokenizer.tokenize(text)
...:                    for text in norm_train_reviews]
...: y_tr = le.fit_transform(train_sentiments)
...: y_train = keras.utils.to_categorical(y_tr, num_classes)
...: # tokenize test reviews & encode test labels
...: tokenized_test = [tn.tokenizer.tokenize(text)
...:                  for text in norm_test_reviews]
...: y_ts = le.fit_transform(test_sentiments)
...: y_test = keras.utils.to_categorical(y_ts, num_classes)
...:
...: # print class label encoding map and encoded labels
...: print('Sentiment class label map:', dict(zip(le.classes_, le.transform(
...:   (le.classes_))))
...: print('Sample test label transformation:\n'+ '-'*35,
...:       '\nActual Labels:', test_sentiments[:3], '\nEncoded Labels:', y_ts[:3],
...:       '\nOne hot encoded Labels:\n', y_test[:3])
Sentiment class label map: {'positive': 1, 'negative': 0}
```

Sample test label transformation:

```
-----
Actual Labels: ['negative' 'positive' 'negative']
Encoded Labels: [0 1 0]
One hot encoded Labels:
[[ 1.  0.]
 [ 0.  1.]
 [ 1.  0.]]
```

Thus, we can see from the preceding sample outputs how our sentiment class labels have been encoded into numeric representations, which in turn have been converted into one-hot encoded vectors. The feature engineering techniques we will be using in this section (Step 3) are slightly more advanced word vectorization techniques that are based on the concept of word embeddings. We will be using the word2vec and GloVe models to generate embeddings. The word2vec model was built by Google and we have covered this in detail in Chapter 4 under the section “Word Embeddings”. We will be choosing the size parameter to be 500 in this scenario representing feature vector size to be 500 for each word.

```
In [9]: # build word2vec model
...: w2v_num_features = 500
...: w2v_model = gensim.models.Word2Vec(tokenized_train, size=w2v_num_features,
...:                                     window=150,
...:                                     min_count=10, sample=1e-3)
```

We will be using the document word vector averaging scheme on this model from Chapter 4 to represent each movie review as an averaged vector of all the word vector representations for the different words in the review. The following function helps us compute averaged word vector representations for any corpus of text documents.

```
def averaged_word2vec_vectorizer(corpus, model, num_features):
    vocabulary = set(model.wv.index2word)
    def average_word_vectors(words, model, vocabulary, num_features):
        feature_vector = np.zeros((num_features,), dtype="float64")
        nwords = 0.
        for word in words:
            if word in vocabulary:
                nwords = nwords + 1.
                feature_vector = np.add(feature_vector, model[word])
        if nwords:
            feature_vector = np.divide(feature_vector, nwords)
        return feature_vector

    features = [average_word_vectors(tokenized_sentence, model, vocabulary, num_features)
                for tokenized_sentence in corpus]
    return np.array(features)
```

We can now use the previous function to generate averaged word vector representations on our two movie review datasets.

```
In [10]: # generate averaged word vector features from word2vec model
...: avg_wv_train_features = averaged_word2vec_vectorizer(corpus=tokenized_train,
...:                                                       model=w2v_model, num_features=500)
...: avg_wv_test_features = averaged_word2vec_vectorizer(corpus=tokenized_test,
...:                                                       model=w2v_model, num_features=500)
```

The GloVe model, which stands for Global Vectors, is an unsupervised model for obtaining word vector representations. Created at Stanford University, this model is trained on various corpora like Wikipedia, Common Crawl, and Twitter and corresponding pre-trained word vectors are available that can be used for our analysis needs. You can refer to the original paper by Jeffrey Pennington, Richard Socher, and Christopher D. Manning, 2014, called *GloVe: Global Vectors for Word Representation*, for more details. The spacy library provided 300-dimensional word vectors trained on the Common Crawl corpus using the GloVe model. They provide a simple standard interface to get feature vectors of size 300 for each word as well as the averaged feature vector of a complete text document. The following snippet leverages spacy to get the GloVe embeddings for our two datasets. Do note that you can also build your own GloVe model by leveraging other pre-trained models or by building a model on your own corpus by using the resources available at <https://nlp.stanford.edu/projects/glove> which contains pre-trained word embeddings, code and examples.

```
In [11]: # feature engineering with GloVe model
...: train_nlp = [tn.nlp(item) for item in norm_train_reviews]
...: train_glove_features = np.array([item.vector for item in train_nlp])
...:
...: test_nlp = [tn.nlp(item) for item in norm_test_reviews]
...: test_glove_features = np.array([item.vector for item in test_nlp])
```

You can check the feature vector dimensions for our datasets based on each of the previous models using the following code.

```
In [12]: print('Word2Vec model:> Train features shape:', avg_wv_train_features.shape,
...:           ' Test features shape:', avg_wv_test_features.shape)
...: print('GloVe model:> Train features shape:', train_glove_features.shape,
...:       ' Test features shape:', test_glove_features.shape)
Word2Vec model:> Train features shape: (35000, 500) Test features shape: (15000, 500)
GloVe model:> Train features shape: (35000, 300) Test features shape: (15000, 300)
```

We can see from the preceding output that as expected the word2vec model features are of size 500 and the GloVe features are of size 300. We can now proceed to Step 4 of our classification system workflow where we will build and train a deep neural network on these features. We have already briefly covered the various aspects and architectures with regard to deep neural networks in Chapter 1 under the section “Deep Learning”. We will be using a fully-connected four layer deep neural network (multi-layer perceptron or deep ANN) for our model. We do not count the input layer usually in any deep architecture, hence our model will consist of three hidden layers of 512 neurons or units and one output layer with two units that will be used to either predict a positive or negative sentiment based on the input layer features. Figure 7-7 depicts our deep neural network model for sentiment classification.



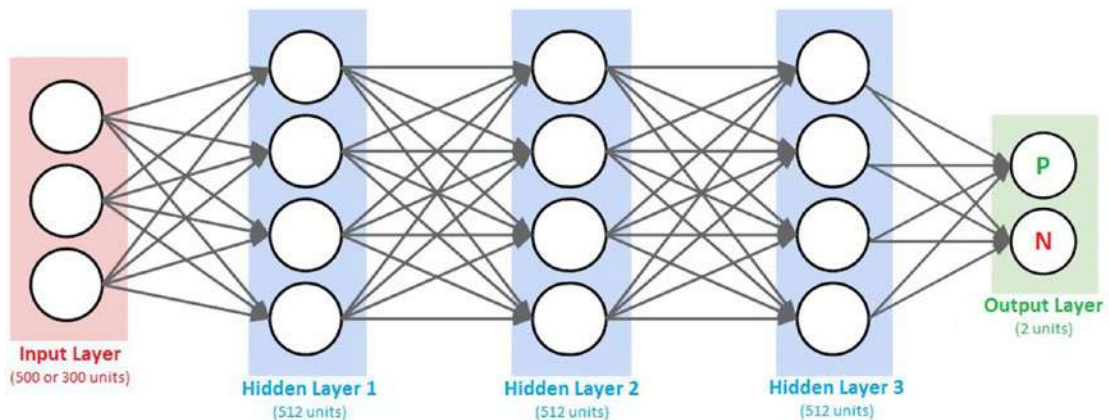

**Figure 7-7.** Fully connected deep neural network model for sentiment classification

We call this a fully connected deep neural network (DNN) because neurons or units in each pair of adjacent layers are fully pairwise connected. These networks are also known as deep artificial neural networks (ANNs) or Multi-Layer Perceptrons (MLPs) since they have more than one hidden layer. The following function leverages keras on top of tensorflow to build the desired DNN model.

```
def construct_deepnn_architecture(num_input_features):
    dnn_model = Sequential()
    dnn_model.add(Dense(512, activation='relu', input_shape=(num_input_features,)))
    dnn_model.add(Dropout(0.2))
    dnn_model.add(Dense(512, activation='relu'))
    dnn_model.add(Dropout(0.2))
    dnn_model.add(Dense(512, activation='relu'))
    dnn_model.add(Dropout(0.2))
    dnn_model.add(Dense(2))
    dnn_model.add(Activation('softmax'))

    dnn_model.compile(loss='categorical_crossentropy', optimizer='adam',
                     metrics=['accuracy'])
    return dnn_model
```

From the preceding function, you can see that we accept a parameter `num_input_features`, which decides the number of units needed in the input layer (500 for `word2vec` and 300 for `glove` features). We build a `Sequential` model, which helps us linearly stack our hidden and output layers.

We use 512 units for all our hidden layers and the activation function `relu` indicates a rectified linear unit. This function is typically defined as  $relu(x) = \max(0, x)$  where  $x$  is typically the input to a neuron. This is popularly known as the ramp function also in electronics and electrical engineering. This function is preferred now as compared to the previously popular sigmoid function because it tries to solve the vanishing gradient problem. This problem occurs when  $x > 0$  and as  $x$  increases, the gradient from sigmoids becomes really small (almost vanishing) but `relu` prevents this from happening. Besides this, it also helps with faster convergence of gradient descent. We also use regularization in the network in the form of `Dropout` layers. By adding a dropout rate of 0.2, it randomly sets 20% of the input feature units to 0 at each update during training the model. This form of regularization helps prevent overfitting the model.

The final output layer consists of two units with a softmax activation function. The softmax function is basically a generalization of the logistic function we saw earlier, which can be used to represent a probability distribution over  $n$  possible class outcomes. In our case  $n=2$  where the class can either be positive or negative and the softmax probabilities will help us determine the same. The binary softmax classifier is also interchangeably known as the binary logistic regression function.

The `compile(...)` method is used to configure the learning or training process of the DNN model before we actually train it. This involves providing a cost or loss function in the loss parameter. This will be the goal or objective which the model will try to minimize. There are various loss functions based on the type of problem you want to solve, for example the mean squared error for regression and categorical cross-entropy for classification. Check out <https://keras.io/losses/> for a list of possible loss functions.

We will be using `categorical_crossentropy`, which helps us minimize the error or loss from the softmax output. We need an optimizer for helping us converge our model and minimize the loss or error function. Gradient descent or stochastic gradient descent is a popular optimizer. We will be using the adam optimizer which only required first order gradients and very little memory. Adam also uses momentum where basically each update is based on not only the gradient computation of the current point but also includes a fraction of the previous update. This helps with faster convergence. You can refer to the original paper from <https://arxiv.org/pdf/1412.6980v8.pdf> for further details on the ADAM optimizer. Finally, the `metrics` parameter is used to specify model performance metrics that are used to evaluate the model when training (but not used to modify the training loss itself). Let's now build a DNN model based on our word2vec input feature representations for our training reviews.

```
In [13]: w2v_dnn = construct_deepnn_architecture(num_input_features=500)
```

You can also visualize the DNN model architecture with the help of `keras`, similar to what we had done in Chapter 4, by using the following code. See Figure 7-8.

```
In [14]: from IPython.display import SVG
...: from keras.utils.vis_utils import model_to_dot
...:
...: SVG(model_to_dot(w2v_dnn, show_shapes=True, show_layer_names=False,
...:                  rankdir='TB').create(prog='dot', format='svg'))
```

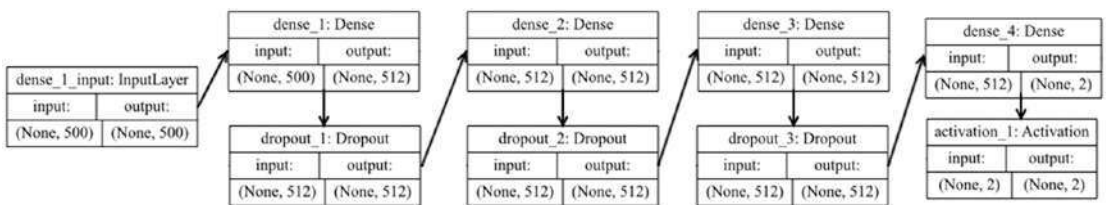

**Figure 7-8.** Visualizing the DNN model architecture using `keras`

We will now be training our model on our training reviews dataset of word2vec features represented by `avg_wv_train_features` (Step 4). We will be using the `fit(...)` function from `keras` for the training process and there are some parameters which you should be aware of. The `epoch` parameter indicates one complete forward and backward pass of all the training examples through the network. The `batch_size` parameter indicates the total number of samples which are propagated through the DNN model at a time for one backward and forward pass for training the model and updating the gradient. Thus if you have 1,000 observations and your batch size is 100, each epoch will consist of 10 iterations where 100 observations will be passed through the network at a time and the weights on the hidden layer units will be updated. We also

specify a `validation_split` of 0.1 to extract 10% of the training data and use it as a validation dataset for evaluating the performance at each epoch. The `shuffle` parameter helps shuffle the samples in each epoch when training the model.

```
In [18]: batch_size = 100
...: w2v_dnn.fit(avg_wv_train_features, y_train, epochs=5, batch_size=batch_size,
...:           shuffle=True, validation_split=0.1, verbose=1)
Train on 31500 samples, validate on 3500 samples
Epoch 1/5 31500/31500 - 11s - loss: 0.3097 - acc: 0.8720 - val_loss: 0.3159 - val_acc: 0.8646
Epoch 2/5 31500/31500 - 11s - loss: 0.2869 - acc: 0.8819 - val_loss: 0.3024 - val_acc: 0.8743
Epoch 3/5 31500/31500 - 11s - loss: 0.2778 - acc: 0.8857 - val_loss: 0.3012 - val_acc: 0.8763
Epoch 4/5 31500/31500 - 11s - loss: 0.2708 - acc: 0.8901 - val_loss: 0.3041 - val_acc: 0.8734
Epoch 5/5 31500/31500 - 11s - loss: 0.2612 - acc: 0.8920 - val_loss: 0.3023 - val_acc: 0.8763
```

The preceding snippet tells us that we have trained our DNN model on the training data for five epochs with 100 as the batch size. We get a validation accuracy of close to 88%, which is quite good. Time now to put our model to the real test! Let's evaluate our model performance on the test review word2vec features (Step 5).

```
In [19]: y_pred = w2v_dnn.predict_classes(avg_wv_test_features)
...: predictions = le.inverse_transform(y_pred)
...: meu.display_model_performance_metrics(true_labels=test_sentiments,
...:           predicted_labels=predictions, classes=['positive', 'negative'])
```

Model Performance metrics:	Model Classification report:				Prediction Confusion Matrix:			
Accuracy: 0.88 Precision: 0.88 Recall: 0.88 F1 Score: 0.88		precision	recall	f1-score	support		Predicted:	
	positive	0.88	0.89	0.88	7510	Actual: positive	6711	799
	negative	0.89	0.87	0.88	7490	negative	952	6538
	avg / total	0.88	0.88	0.88	15000			

**Figure 7-9.** Model performance metrics for deep neural networks on word2vec features

The results depicted in Figure 7-9 show us that we have obtained a model **accuracy** and **F1-score** of **88%**, which is great! You can use a similar workflow to build and train a DNN model for our GloVe based features and evaluate the model performance. The following snippet depicts the workflow for Steps 4 and 5 of our text classification system blueprint.

```
# build DNN model
glove_dnn = construct_deepnn_architecture(num_input_features=300)
# train DNN model on GloVe training features
batch_size = 100
glove_dnn.fit(train_glove_features, y_train, epochs=5, batch_size=batch_size,
              shuffle=True, validation_split=0.1, verbose=1)
# get predictions on test reviews
y_pred = glove_dnn.predict_classes(test_glove_features)
predictions = le.inverse_transform(y_pred)
# Evaluate model performance
meu.display_model_performance_metrics(true_labels=test_sentiments, predicted_
labels=predictions,
                                     classes=['positive', 'negative'])
```

We obtained an overall model **accuracy** and **F1-score** of **85%** with the GloVe features, which is still good but not better than what we obtained using our word2vec features. You can refer to the `Sentiment Analysis - Supervised.ipynb` jupyter notebook to see the step-by-step outputs obtained for the previous code. This concludes our discussion on building text sentiment classification systems leveraging newer Deep Learning models and methodologies. Onwards to learning about advanced Deep Learning models!

## Advanced Supervised Deep Learning Models

We have used fully connected deep neural network and word embeddings in the previous section. Another new and interesting approach toward supervised Deep Learning is the use of recurrent neural networks (RNNs) and long short term memory networks (LSTMs) which also considers the sequence of data (words, events, and so on). These are more advanced models than your regular fully connected deep networks and usually take more time to train. We will leverage keras on top of tensorflow and try to build a LSTM-based classification model here and use word embeddings as our features. You can refer to the Python file titled `sentiment_analysis_adv_deep_learning.py` for all the code used in this section or use the jupyter notebook titled `Sentiment Analysis - Advanced Deep Learning.ipynb` for a more interactive experience.

We will be working on our normalized and pre-processed train and test review datasets, `norm_train_reviews` and `norm_test_reviews`, which we created in our previous analyses. Assuming you have them loaded up, we will first tokenize these datasets such that each text review is decomposed into its corresponding tokens (workflow Step 2).

```
In [1]: tokenized_train = [tn.tokenizer.tokenize(text) for text in norm_train_reviews]
...: tokenized_test = [tn.tokenizer.tokenize(text) for text in norm_test_reviews]
```

For feature engineering (Step 3), we will be creating word embeddings. However, we will create them ourselves using keras instead of using pre-built ones like word2vec or GloVe, which we used earlier. Word embeddings tend to vectorize text documents into fixed sized vectors such that these vectors try to capture contextual and semantic information.

For generating embeddings, we will use the Embedding layer from keras, which requires documents to be represented as tokenized and numeric vectors. We already have tokenized text vectors in our `tokenized_train` and `tokenized_text` variables. However we would need to convert them into numeric representations. Besides this, we would also need the vectors to be of uniform size even though the tokenized text reviews will be of variable length due to the difference in number of tokens in each review. For this, one strategy could be to take the length of the longest review (with maximum number of tokens\words) and set it as the vector size, let's call this `max_len`. Reviews of shorter length can be padded with a PAD term in the beginning to increase their length to `max_len`.

We would need to create a word to index vocabulary mapping for representing each tokenized text review in a numeric form. Do note you would also need to create a numeric mapping for the padding term which we shall call `PAD_INDEX` and assign it the numeric index of 0. For unknown terms, in case they are encountered later on in the test dataset or newer, previously unseen reviews, we would need to assign it to some index too. This would be because we will vectorize, engineer features, and build models only on the training data. Hence, if some new term should come up in the future (which was originally not a part of the model training), we will consider it as an out of vocabulary (**OOV**) term and assign it to a constant index (we will name this term `NOT_FOUND_INDEX` and assign it the index of `vocab_size+1`). The following snippet helps us create this vocabulary from our `tokenized_train` corpus of training text reviews.

```
In [2]: from collections import Counter
...:
...: # build word to index vocabulary
...: token_counter = Counter([token for review in tokenized_train for token in review])
...: vocab_map = {item[0]: index+1
...:               for index, item in enumerate(dict(token_counter).items())}
...: max_index = np.max(list(vocab_map.values()))
...: vocab_map['PAD_INDEX'] = 0
...: vocab_map['NOT_FOUND_INDEX'] = max_index+1
...: vocab_size = len(vocab_map)
...: # view vocabulary size and part of the vocabulary map
...: print('Vocabulary Size:', vocab_size)
...: print('Sample slice of vocabulary map:', dict(list(vocab_map.items())[10:20]))
Vocabulary Size: 82358
Sample slice of vocabulary map: {'martyrdom': 6, 'palmira': 7, 'servility': 8, 'gardening':
9, 'melodramatically': 73505, 'renfro': 41282, 'carlin': 41283, 'overtly': 41284, 'rend':
47891, 'anticlimactic': 51}
```

In this case we have used all the terms in our vocabulary, you can easily filter and use more relevant terms here (based on their frequency) by using the `most_common(count)` function from `Counter` and taking the first count terms from the list of unique terms in the training corpus. We will now encode the tokenized text reviews based on the previous `vocab_map`. Besides this, we will also encode the text sentiment class labels into numeric representations.

```
In [3]: from keras.preprocessing import sequence
...: from sklearn.preprocessing import LabelEncoder
...:
...: # get max length of train corpus and initialize label encoder
...: le = LabelEncoder()
...: num_classes=2 # positive -> 1, negative -> 0
...: max_len = np.max([len(review) for review in tokenized_train])
...:
...: ## Train reviews data corpus
...: # Convert tokenized text reviews to numeric vectors
...: train_X = [[vocab_map[token] for token in tokenized_review]
...:             for tokenized_review in tokenized_train]
...: train_X = sequence.pad_sequences(train_X, maxlen=max_len) # pad
...: ## Train prediction class labels
...: # Convert text sentiment labels (negative\positive) to binary encodings (0/1)
...: train_y = le.fit_transform(train_sentiments)
...:
...: ## Test reviews data corpus
...: # Convert tokenized text reviews to numeric vectors
...: test_X = [[vocab_map[token] if vocab_map.get(token) else vocab_map['NOT_FOUND_INDEX']
...:            for token in tokenized_review]
...:           for tokenized_review in tokenized_test]
...: test_X = sequence.pad_sequences(test_X, maxlen=max_len)
```

```

...: ## Test prediction class labels
...: # Convert text sentiment labels (negative\positive) to binary encodings (0/1)
...: test_y = le.transform(test_sentiments)
...:
...: # view vector shapes
...: print('Max length of train review vectors:', max_len)
...: print('Train review vectors shape:', train_X.shape,
        ' Test review vectors shape:', test_X.shape)

```

```

Max length of train review vectors: 1442
Train review vectors shape: (35000, 1442) Test review vectors shape: (15000, 1442)

```

From the preceding code snippet and the output, it is clear that we encoded each text review into a numeric sequence vector so that the size of each review vector is 1442, which is basically the maximum length of reviews from the training dataset. We pad shorter reviews and truncate extra tokens from longer reviews such that the shape of each review is constant as depicted in the output. We can now proceed with Step 3 and a part of Step 4 of the classification workflow by introducing the Embedding layer and coupling it with the deep network architecture based on LSTMs.

```

from keras.models import Sequential
from keras.layers import Dense, Embedding, Dropout, SpatialDropout1D
from keras.layers import LSTM

EMBEDDING_DIM = 128 # dimension for dense embeddings for each token
LSTM_DIM = 64 # total LSTM units

model = Sequential()
model.add(Embedding(input_dim=vocab_size, output_dim=EMBEDDING_DIM, input_length=max_len))
model.add(SpatialDropout1D(0.2))
model.add(LSTM(LSTM_DIM, dropout=0.2, recurrent_dropout=0.2))
model.add(Dense(1, activation="sigmoid"))

model.compile(loss="binary_crossentropy", optimizer="adam",
              metrics=["accuracy"])

```

The Embedding layer helps us generate the word embeddings from scratch. This layer is also initialized with some weights initially and this gets updated based on our optimizer similar to weights on the neuron units in other layers when the network tries to minimize the loss in each epoch. Thus, the embedding layer tries to optimize its weights such that we get the best word embeddings which will generate minimum error in the model and also capture semantic similarity and relationships among words. How do we get the embeddings, let's consider we have a review with 3 terms ['movie', 'was', 'good'] and a vocab\_map consisting of word to index mappings for 82358 words. The word embeddings would be generated somewhat similar to Figure 7-10.

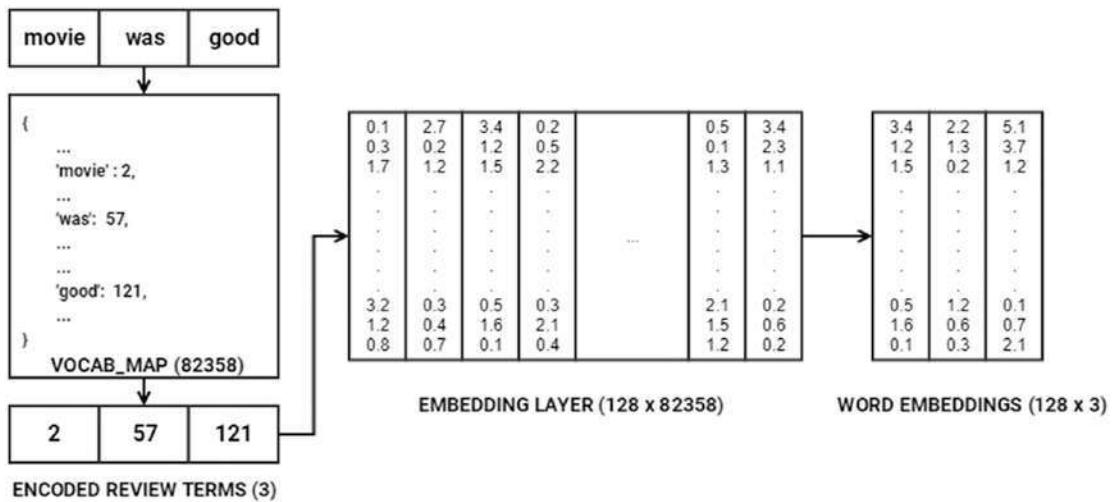
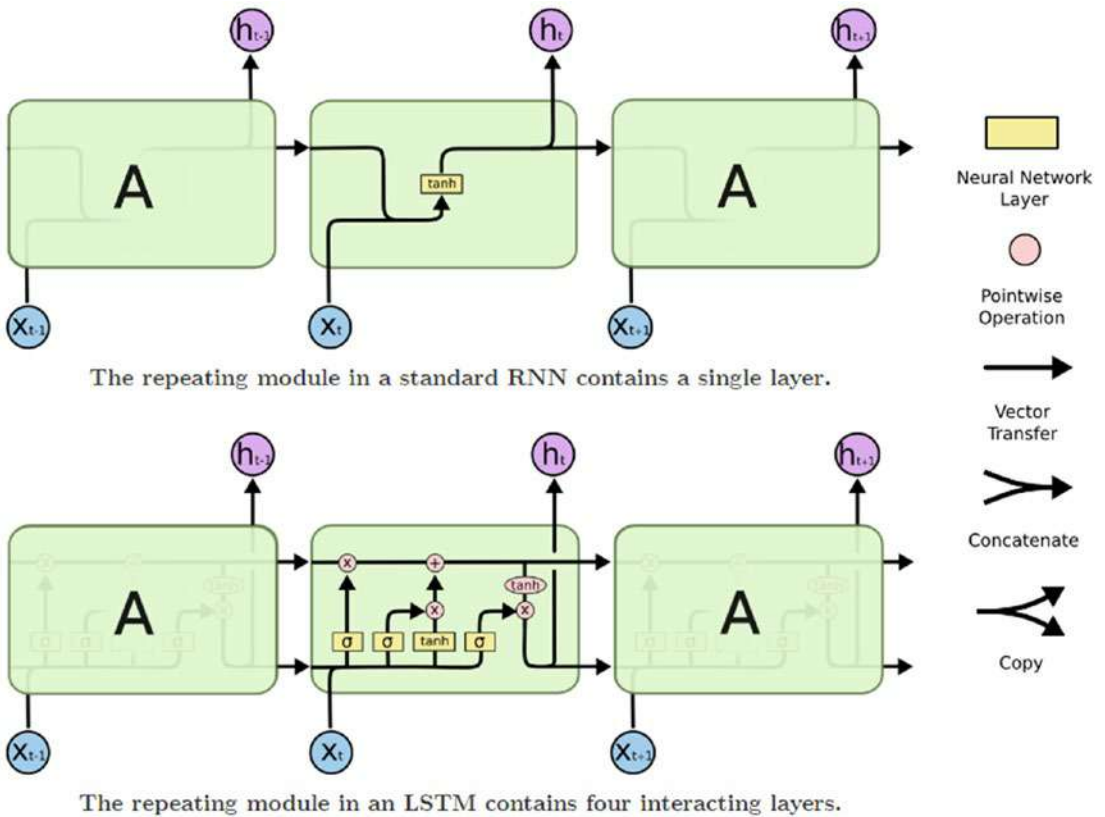

Figure 7-10. Understanding how word embeddings are generated

Based on our model architecture, the Embedding layer takes in three parameters—`input_dim`, which is equal to the vocabulary size (`vocab_size`) of 82358, `output_dim`, which is 128, representing the dimension of dense embedding (depicted by rows in the EMBEDDING LAYER in Figure 7-10), and `input_len`, which specifies the length of the input sequences (movie review sequence vectors), which is 1442. In the example depicted in Figure 7-10, since we have one review, the dimension is (1, 3). This review is converted into a numeric sequence [2, 57, 121] based on the VOCAB\_MAP. Then the specific columns representing the indices in the review sequence are selected from the EMBEDDING LAYER (vectors at column indices 2, 57 and 121 respectively), to generate the final word embeddings. This gives us an embedding vector of dimension (1, 128, 3) also represented as (1, 3, 128) when each row is represented based on each sequence word embedding vector. Many Deep Learning frameworks like keras represent the embedding dimensions as (m, n) where m represents all the unique terms in our vocabulary (82358) and n represents the output\_dim which is 128 in this case. Consider a transposed version of the layer depicted in Figure 7-10 and you are good to go!

Usually if you have the encoded review terms sequence vector represented in one-hot encoded format (3, 82358) and do a matrix multiplication with the EMBEDDING LAYER represented as (82358, 128) where each row represents the embedding for a word in the vocabulary, you will directly obtain the word embeddings for the review sequence vector as (3, 128). The weights in the embedding layer get updated and optimized in each epoch based on the input data when propagated through the whole network like we mentioned earlier such that overall loss and error is minimized to get maximum model performance.

These dense word embeddings are then passed to the LSTM layer having 64 units. We already introduced you to the LSTM architecture briefly in Chapter 1 in the subsection titled “Long Short Term Memory Networks” in the “Important Concepts” section under “Deep Learning”. LSTMs basically try to overcome the shortcomings of RNN models especially with regard to handling long term dependencies and problems which occur when the weight matrix associated with the units (neurons) become too small (leading to vanishing gradient) or too large (leading to exploding gradient). These architectures are more complex than regular deep networks and going into detailed internals and math concepts would be out of the current scope, but we will try to cover the essentials here without making it math heavy. If you’re interested in researching the internals of LSTMs, check out the original paper which inspired it all, by Hochreiter, S., and Schmidhuber, J. (1997). *Long short-term memory. Neural computation. 9(8), 1735-1780*. We depict the basic architecture of RNNs and compare it with LSTMs in Figure 7-11.



**Figure 7-11.** Basic structure of RNN and LSTM units (Source: Christopher Olah’s blog: colah.github.io)

The RNN units usually have a chain of repeating modules (this happens when we unroll the loop; refer to Figure 1-13 in Chapter 1, where we talk about this) such that the module has a simple structure of having maybe one layer with the tanh activation. LSTMs are also a special type of RNN, having a similar structure but the LSTM unit has four neural network layers instead of just one. The detailed architecture of the LSTM cell is shown in Figure 7-12.



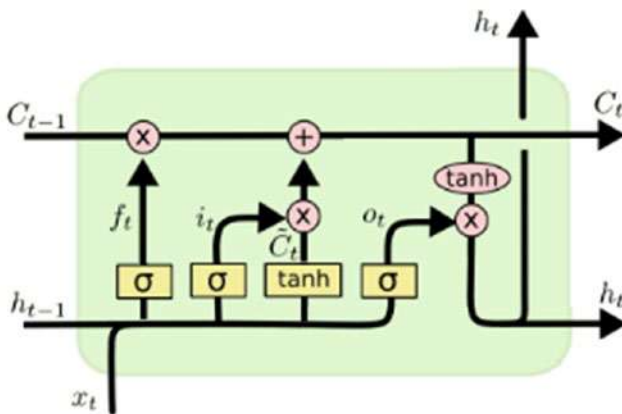
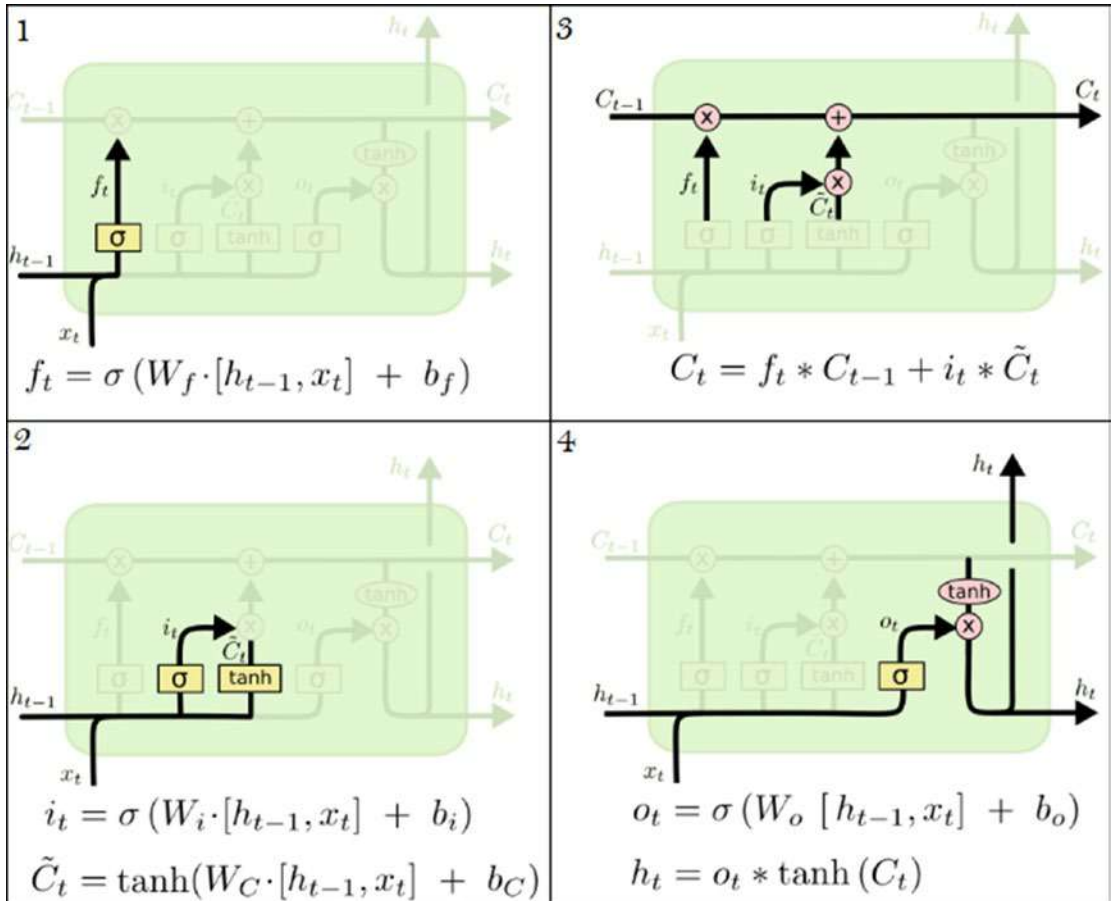

**Figure 7-12.** Detailed architecture of an LSTM cell (Source: Christopher Olah’s blog: colah.github.io)

The detailed architecture of an LSTM cell is depicted in Figure 7-12. The notation  $t$  indicates one time step,  $C$  depicts the cell states, and  $h$  indicates the hidden states. The gates  $i, f, o, \tilde{C}$  help in removing or adding information to the cell state. The gates  $i, f$  &  $o$  represent the *input*, *output* and *forget* gates respectively and each of them are modulated by the sigmoid layer which outputs numbers from 0 to 1 controlling how much of the output from these gates should pass. Thus this helps in protecting and controlling the cell state. Detailed work flow of how information flows through the LSTM cell is depicted in Figure 7-13 in four steps.

1. The first step talks about the forget gate layer  $f$ , which helps us decide what information should we throw away from the cell state. This is done by looking at the previous hidden state  $h_{t-1}$  and current inputs  $x_t$  as depicted in the equation. The sigmoid layer helps control how much of this should be kept or forgotten.
2. The second step depicts the input gate layer  $i$ , which helps decide what information will be stored in the current cell state. The sigmoid layer in the input gate helps decide which values will be updated based on  $h_{t-1}$  &  $x_t$  again. The tanh layer helps create a vector of the new candidate values  $\tilde{C}_t$  based on  $h_{t-1}$  &  $x_t$ , which can be added to the current cell state. Thus the tanh layer creates the values and the input gate with sigmoid layer helps choose which values should be updated.
3. The third step involves updating the old cell state  $C_{t-1}$  to the new cell state  $C_t$  by leveraging what we obtained in the first two steps. We multiply the old cell state by the forget gate ( $f_t \times C_{t-1}$ ) and then add the new candidate values scaled by the input gate with sigmoid layer ( $i_t \times \tilde{C}_t$ ).
4. The fourth and final step helps us decide what should be the final output which is basically a filtered version of our cell state. The output gate with the sigmoid layer  $o$  helps us select which parts of the cell state will pass to the final output. This is multiplied with the cell state values when passed through the tanh layer to give us the final hidden state values  $h_t = o_t \times \tanh(\tilde{C}_t)$ .

All these steps in this detailed workflow are depicted in Figure 7-13 with necessary annotations and equations. We would like to thank our good friend Christopher Olah for providing us detailed information as well as the images for depicting the internal workings of LSTM networks. We recommend checking out Christopher’s blog at <http://colah.github.io/posts/2015-08-Understanding-LSTMs> for more details. A shout out also goes to Edwin Chen, for explaining RNNs and LSTMs in an easy-to-understand format. We recommend referring to Edwin’s blog at <http://blog.echen.me/2017/05/30/exploring-lstms> for information on the workings of RNNs and LSTMs.



**Figure 7-13.** Walkthrough of data flow in an LSTM cell (Source: Christopher Olah’s blog: [colah.github.io](http://colah.github.io))

The final layer in our deep network is the Dense layer with 1 unit and the sigmoid activation function. We basically use the `binary_crossentropy` function with the `adam` optimizer since this is a binary classification problem and the model will ultimately predict a 0 or a 1, which we can decode back to a negative or positive sentiment prediction with our label encoder. You can also use the `categorical_crossentropy` loss function here, but you would need to then use a Dense layer with 2 units instead with a `softmax` function. Now that our model is compiled and ready, we can head on to Step 4 of our classification workflow of actually training the model. We use a similar strategy from our previous deep network models, where we train our model on the training data with five epochs, batch size of 100 reviews, and a 10% validation split of training data to measure validation accuracy.

```
In [4]: batch_size = 100
...: model.fit(train_X, train_y, epochs=5, batch_size=batch_size,
...:           shuffle=True, validation_split=0.1, verbose=1)
Train on 31500 samples, validate on 3500 samples
Epoch 1/5 31500/31500 - 2491s - loss: 0.4081 - acc: 0.8184 - val_loss: 0.3006 - val_acc: 0.8751
Epoch 2/5 31500/31500 - 2489s - loss: 0.2253 - acc: 0.9158 - val_loss: 0.3209 - val_acc: 0.8780
Epoch 3/5 31500/31500 - 2656s - loss: 0.1431 - acc: 0.9493 - val_loss: 0.3483 - val_acc: 0.8671
Epoch 4/5 31500/31500 - 2604s - loss: 0.1023 - acc: 0.9658 - val_loss: 0.3803 - val_acc: 0.8729
Epoch 5/5 31500/31500 - 2701s - loss: 0.0694 - acc: 0.9761 - val_loss: 0.4430 - val_acc: 0.8706
```

Training LSTMs on CPU is notoriously slow and as you can see my model took approximately 3.6 hours to train for just five epochs on an i5 3rd Gen Intel CPU with 8 GB of memory. Of course, a cloud-based environment like Google Cloud Platform or AWS on GPU took me approximately less than an hour to train the same model. So I would recommend you choose a GPU based Deep Learning environment, especially when working with RNNs or LSTM based network architectures. Based on the preceding output, we can see that just with five epochs we have decent validation accuracy but the training accuracy starts shooting up indicating some over-fitting might be happening. Ways to overcome this include adding more data or by increasing the dropout rate. Do give it a shot and see if it works! Time to put our model to the test! Let's see how well it predicts the sentiment for our test reviews and use the same model evaluation framework we have used for our previous models (Step 5).

```
In [5]: # predict sentiments on test data
...: pred_test = model.predict_classes(test_X)
...: predictions = le.inverse_transform(pred_test.flatten())
...: # evaluate model performance
...: meu.display_model_performance_metrics(true_labels=test_sentiments,
...:                                     predicted_labels=predictions, classes=['positive', 'negative'])
```

Model Performance metrics:	Model Classification report:				Prediction Confusion Matrix:			
Accuracy: 0.88 Precision: 0.88 Recall: 0.88 F1 Score: 0.88		precision	recall	f1-score	support	Actual: positive	Predicted: positive negative	
	positive	0.88	0.89	0.88	7510	negative	6711	799
	negative	0.89	0.87	0.88	7490	negative	952	6538
	avg / total	0.88	0.88	0.88	15000			

**Figure 7-14.** Model performance metrics for LSTM based Deep Learning model on word embeddings

The results depicted in Figure 7-14 show us that we have obtained a model **accuracy** and **F1-score** of **88%**, which is quite good! With more quality data, you can expect to get even better results. Try experimenting with different architectures and see if you get better results!

## Analyzing Sentiment Causation

We built both supervised and unsupervised models to predict the sentiment of movie reviews based on the review text content. While feature engineering and modeling is definitely the need of the hour, you also need to know how to analyze and interpret the root cause behind how model predictions work. In this section, we analyze sentiment causation. The idea is to determine the root cause or key factors causing positive or negative sentiment. The first area of focus will be model interpretation, where we will try to understand, interpret, and explain the mechanics behind predictions made by our classification models. The second area of focus is to apply topic modeling and extract key topics from positive and negative sentiment reviews.

### Interpreting Predictive Models

One of the challenges with Machine Learning models is the transition from a pilot or proof-of-concept phase to the production phase. Business and key stakeholders often perceive Machine Learning models as complex black boxes and poses the question, why should I trust your model? Explaining to them complex mathematical or theoretical concepts doesn't serve the purpose. Is there some way in which we can explain these models in an easy-to-interpret manner? This topic in fact has gained extensive attention very recently in 2016. Refer to the original research paper by M.T. Ribeiro, S. Singh & C. Guestrin titled "Why Should I Trust You?: Explaining the Predictions of Any Classifier" from <https://arxiv.org/pdf/1602.04938.pdf> to understand more about model interpretation and the LIME framework. Check out more on model interpretation in Chapter 5 where we cover the skater framework in detail which performs excellent interpretations of various models.

There are various ways to interpret the predictions made by our predictive sentiment classification models. We want to understand more into why a positive review was correctly predicted as having positive sentiment or a negative review having negative sentiment. Besides this, no model is a 100% accurate always, so we would also want to understand the reason for mis-classifications or wrong predictions. The code used in this section is available in the file named `sentiment_causal_model_interpretation.py` or you can also refer to the jupyter notebook named `Sentiment Causal Analysis - Model Interpretation.ipynb` for an interactive experience.

Let's first build a basic text classification pipeline for the model that worked best for us so far. This is the Logistic Regression model based on the Bag of Words feature model. We will leverage the pipeline module from `scikit-learn` to build this Machine Learning pipeline using the following code.

```
from sklearn.feature_extraction.text import CountVectorizer
from sklearn.linear_model import LogisticRegression
from sklearn.pipeline import make_pipeline

# build BOW features on train reviews
cv = CountVectorizer(binary=False, min_df=0.0, max_df=1.0, ngram_range=(1,2))
cv_train_features = cv.fit_transform(norm_train_reviews)
# build Logistic Regression model
lr = LogisticRegression()
lr.fit(cv_train_features, train_sentiments)

# Build Text Classification Pipeline
lr_pipeline = make_pipeline(cv, lr)

# save the list of prediction classes (positive, negative)
classes = list(lr_pipeline.classes_)
```

We build our model based on `norm_train_reviews`, which contains the normalized training reviews that we have used in all our earlier analyses. Now that we have our classification pipeline ready, you can actually deploy the model by using `pickle` or `joblib` to save the classifier and feature objects similar to what we discussed in the “Model Deployment” section in Chapter 5. Assuming our pipeline is in production, how do we use it for new movie reviews? Let’s try to predict the sentiment for two new sample reviews (which were not used in training the model).

```
In [3]: lr_pipeline.predict(['the lord of the rings is an excellent movie',
...:                        'i hated the recent movie on tv, it was so bad'])
Out[3]: array(['positive', 'negative'], dtype=object)
```

Our classification pipeline predicts the sentiment of both the reviews correctly! This is a good start, but how do we interpret the model predictions? One way is to typically use the model prediction class probabilities as a measure of confidence. You can use the following code to get the prediction probabilities for our sample reviews.

```
In [4]: pd.DataFrame(lr_pipeline.predict_proba(['the lord of the rings is an excellent movie',
...:                                           'i hated the recent movie on tv, it was so bad']),
columns=classes)
Out[4]:
   negative  positive
0  0.169653  0.830347
1  0.730814  0.269186
```

Thus we can say that the first movie review has a prediction confidence or probability of 83% to have positive sentiment as compared to the second movie review with a 73% probability to have negative sentiment. Let’s now kick it up a notch, instead of playing around with toy examples, we will now run the same analysis on actual reviews from the `test_reviews` dataset (we will use `norm_test_reviews`, which has the normalized text reviews). Besides prediction probabilities, we will be using the `skater` framework for easy interpretation of the model decisions, similar to what we have done in Chapter 5 under the section “Model Interpretation”. You need to load the following dependencies from the `skater` package first. We also define a helper function which takes in a document index, a corpus, its response predictions, and an explainer object and helps us with the our model interpretation analysis.

```
from skater.core.local_interpretation.lime.lime_text import LimeTextExplainer

explainer = LimeTextExplainer(class_names=classes)
# helper function for model interpretation
def interpret_classification_model_prediction(doc_index, norm_corpus, corpus,
                                           prediction_labels, explainer_obj):
    # display model prediction and actual sentiments
    print("Test document index: {index}\nActual sentiment: {actual}
          \nPredicted sentiment: {predicted}"
          .format(index=doc_index, actual=prediction_labels[doc_index],
                  predicted=lr_pipeline.predict([norm_corpus[doc_index]])))
    # display actual review content
    print("\nReview:", corpus[doc_index])
    # display prediction probabilities
    print("\nModel Prediction Probabilities:")
    for probs in zip(classes, lr_pipeline.predict_proba([norm_corpus[doc_index]])[0]):
        print(probs)
```

```
# display model prediction interpretation
exp = explainer.explain_instance(norm_corpus[doc_index],
                                lr_pipeline.predict_proba, num_features=10,
                                labels=[1])

exp.show_in_notebook()
```

The preceding snippet leverages skater to explain our text classifier to analyze its decision-making process in an easy to interpret form. Even though the model might be a complex one in a global perspective, it is easier to explain and approximate the model behavior on local instances. This is done by learning the model around the vicinity of the data point of interest  $X$  by sampling instances around  $X$  and assigning weightages based on their proximity to  $X$ . Thus, these locally learned linear models help in explaining complex models in a more easy to interpret way with class probabilities, contribution of top features to the class probabilities that aid in the decision making process. Let's take a movie review from our test dataset where both the actual and predicted sentiment is negative and analyze it with the helper function we created in the preceding snippet.

```
In [6]: doc_index = 100
...: interpret_classification_model_prediction(doc_index=doc_index, corpus=norm_test_
reviews,
                                            corpus=test_reviews, prediction_labels=test_
sentiments,
                                            explainer_obj=explainer)
```

```
Test document index: 100
Actual sentiment: negative
Predicted sentiment: ['negative']
```

Review: Worst movie, (with the best reviews given it) I've ever seen. Over the top dialog, acting, and direction. more slasher flick than thriller. With all the great reviews this movie got I'm appalled that it turned out so silly. shame on you Martin Scorsese

```
Model Prediction Probabilities:
('negative', 0.8099323456145181)
('positive', 0.19006765438548187)
```

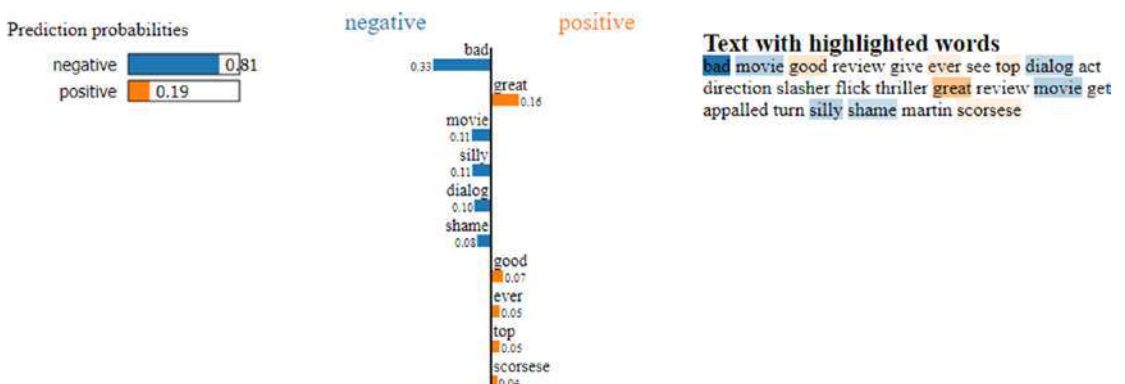

**Figure 7-15.** Model interpretation for our classification model's correct prediction for a negative review

The results depicted in Figure 7-15 show us the class prediction probabilities and also the top 10 features that contributed the maximum to the prediction decision making process. These key features are also highlighted in the normalized movie review text. Our model performs quite well in this scenario and we can see the key features that contributed to the negative sentiment of this review including bad, silly, dialog, and shame, which make sense. Besides this, the word great contributed the maximum to the positive probability of 0.19 and in fact if we had removed this word from our review text, the positive probability would have dropped significantly.

The following code runs a similar analysis on a test movie review with both actual and predicted sentiment of positive value.

```
In [7]: doc_index = 2000
...: interpret_classification_model_prediction(doc_index=doc_index, corpus=norm_test_
reviews,
                                             corpus=test_reviews, prediction_labels=test_
sentiments,
                                             explainer_obj=explainer)
```

```
Test document index: 2000
Actual sentiment: positive
Predicted sentiment: ['positive']
```

Review: I really liked the Movie "JOE." It has really become a cult classic among certain age groups.<br /><br />The Producer of this movie is a personal friend of mine. He is my Stepsons Father-In-Law. He lives in Manhattan's West side, and has a Bungalow in Southampton, Long Island. His son-in-law live next door to his Bungalow.<br /><br />Presently, he does not do any Producing, But dabbles in a business with HBO movies.<br /><br />As a person, Mr. Gil is a real gentleman and I wish he would have continued in the production business of move making.

```
Model Prediction Probabilities:
('negative', 0.020629181561415355)
('positive', 0.97937081843858464)
```



Figure 7-16. Model interpretation for our classification model's correct prediction for a positive review

The results depicted in Figure 7-16 show the top features responsible for the model making a decision of predicting this review as positive. Based on the content, the reviewer really liked this model and also it was a real cult classic among certain age groups. In our final analysis, we will look at the model interpretation of an example where the model makes a wrong prediction.

```
In [8]: doc_index = 347
...: interpret_classification_model_prediction(doc_index=doc_index, corpus=norm_test_
reviews,
corpus=test_reviews, prediction_labels=test_
sentiments,
explainer_obj=explainer)
```

```
Test document index: 347
Actual sentiment: negative
Predicted sentiment: ['positive']
```

Review: When I first saw this film in cinema 11 years ago, I loved it. I still think the directing and cinematography are excellent, as is the music. But it's really the script that has over the time started to bother me more and more. I find Emma Thompson's writing self-absorbed and unfaithful to the original book; she has reduced Marianne to a side-character, a second fiddle to her much too old, much too severe Elinor - she in the movie is given many sort of 'focus moments', and often they appear to be there just to show off Thompson herself.<br /><br />I do understand her cutting off several characters from the book, but leaving out the one scene where Willoughby in the book is redeemed? For someone who red and cherished the book long before the movie, those are the things always difficult to digest.<br /><br />As for the actors, I love Kate Winslet as Marianne. She is not given the best script in the world to work with but she still pulls it up gracefully, without too much sentimentality. Alan Rickman is great, a bit old perhaps, but he plays the role beautifully. And Elizabeth Spriggs, she is absolutely fantastic as always.

```
Model Prediction Probabilities:
('negative', 0.067198213044844413)
('positive', 0.93280178695515559)
```

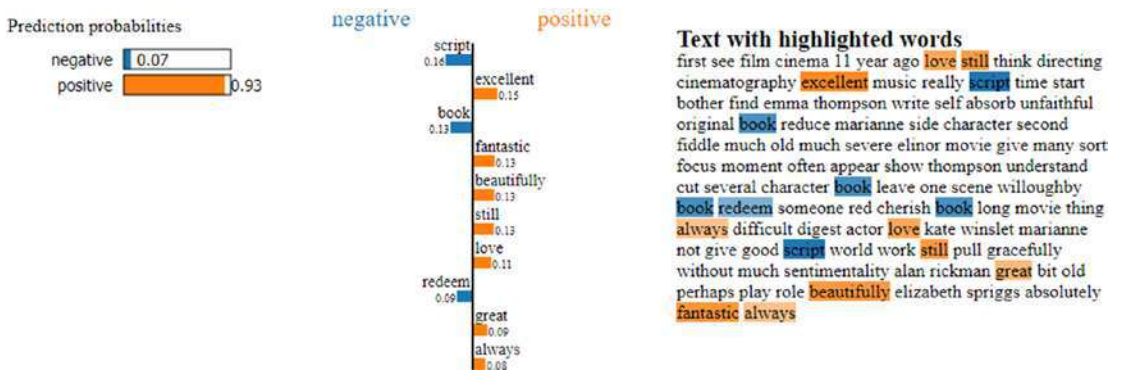

Figure 7-17. Model interpretation for our classification model's incorrect prediction



The preceding output tells us that our model predicted the movie review indicating a positive sentiment when in-fact the actual sentiment label is negative for the same review. The results depicted in Figure 7-17 tell us that the reviewer in fact shows signs of positive sentiment in the movie review, especially in parts where he/she tells us that “I loved it. I still think the directing and cinematography are excellent, as is the music... Alan Rickman is great, a bit old perhaps, but he plays the role beautifully. And Elizabeth Spriggs, she is absolutely fantastic as always.” and feature words from the same have been depicted in the top features contributing to positive sentiment. The model interpretation also correctly identifies the aspects of the review contributing to negative sentiment like, “But it’s really the script that has over the time started to bother me more and more.”. Hence, this is one of the more complex reviews which indicate both positive and negative sentiment and the final interpretation would be in the reader’s hands. You can now use this same framework to interpret your own classification models in the future and understand where your model might be performing well and where it might need improvements!

## Analyzing Topic Models

Another way of analyzing key terms, concepts or topics responsible for sentiment is to use a different approach known as topic modeling. We have already covered some basics into topic modeling in the section titled “Topic Models” under “Feature Engineering on Text Data” in Chapter 4. The main aim of topic models is to extract and depict key topics or concepts which are otherwise latent and not very prominent in huge corpora of text documents. We have already seen the use of Latent Dirichlet Allocation (LDA) for topic modeling in Chapter 4. In this section, we use another topic modeling technique called Non-Negative Matrix factorization. Refer to the Python file named `sentiment_causal_topic_models.py` or the jupyter notebook titled `Sentiment Causal Analysis - Topic Models.ipynb` for a more interactive experience.

The first step in this analysis is to combine all our normalized train and test reviews and separate out these reviews into positive and negative sentiment reviews. Once we do this, we will extract features from these two datasets using the TF-IDF feature vectorizer. The following snippet helps us achieve this.

```
In [11]: from sklearn.feature_extraction.text import TfidfVectorizer
...:
...: # consolidate all normalized reviews
...: norm_reviews = norm_train_reviews+norm_test_reviews
...: # get tf-idf features for only positive reviews
...: positive_reviews = [review for review, sentiment in zip(norm_reviews, sentiments)
...:                     if sentiment == 'positive']
...: ptvf = TfidfVectorizer(use_idf=True, min_df=0.05, max_df=0.95,
...:                       ngram_range=(1,1), sublinear_tf=True)
...: ptvf_features = ptvf.fit_transform(positive_reviews)
...: # get tf-idf features for only negative reviews
...: negative_reviews = [review for review, sentiment in zip(norm_reviews, sentiments)
...:                     if sentiment == 'negative']
...: ntvf = TfidfVectorizer(use_idf=True, min_df=0.05, max_df=0.95,
...:                       ngram_range=(1,1), sublinear_tf=True)
...: ntvf_features = ntvf.fit_transform(negative_reviews)
...: # view feature set dimensions
...: print(ptvf_features.shape, ntvf_features.shape)
```

```
(25000, 331) (25000, 331)
```

From the preceding output dimensions, you can see that we have filtered out a lot of the features we used previously when building our classification models by making `min_df` to be 0.05 and `max_df` to be 0.95. This is to speed up the topic modeling process and remove features that either occur too much or too rarely. Let's now import the necessary dependencies for the topic modeling process.

```
In [12]: import pyLDAvis
...: import pyLDAvis.sklearn
...: from sklearn.decomposition import NMF
...: import topic_model_utils as tmu
...:
...: pyLDAvis.enable_notebook()
...: total_topics = 10
```

The NMF class from scikit-learn will help us with topic modeling. We also use `pyLDAvis` for building interactive visualizations of topic models. The core principle behind Non-Negative Matrix Factorization (NNMF) is to apply matrix decomposition (similar to SVD) to a non-negative feature matrix  $X$  such that the decomposition can be represented as  $X \approx WH$  where  $W$  &  $H$  are both non-negative matrices which if multiplied should approximately re-construct the feature matrix  $X$ . A cost function like L2 norm can be used for getting this approximation. Let's now apply NNMF to get 10 topics from our positive sentiment reviews. We will also leverage some utility functions from our `topic_model_utils` module to display the results in a clean format.

```
In [13]: # build topic model on positive sentiment review features
...: pos_nmf = NMF(n_components=total_topics,
...:               random_state=42, alpha=0.1, l1_ratio=0.2)
...: pos_nmf.fit(ptvf_features)
...: # extract features and component weights
...: pos_feature_names = ptvf.get_feature_names()
...: pos_weights = pos_nmf.components_
...: # extract and display topics and their components
...: pos_topics = tmu.get_topics_terms_weights(pos_weights, pos_feature_names)
...: tmu.print_topics_udf(topics=pos_topics, total_topics=total_topics,
...:                     num_terms=15, display_weights=False)
Topic #1 without weights
['like', 'not', 'think', 'really', 'say', 'would', 'get', 'know', 'thing', 'much', 'bad',
'go', 'lot', 'could', 'even']

Topic #2 without weights
['movie', 'see', 'watch', 'great', 'good', 'one', 'not', 'time', 'ever', 'enjoy',
'recommend', 'make', 'acting', 'like', 'first']

Topic #3 without weights
['show', 'episode', 'series', 'tv', 'watch', 'dvd', 'first', 'see', 'time', 'one', 'good',
'year', 'remember', 'ever', 'would']

Topic #4 without weights
['performance', 'role', 'play', 'actor', 'cast', 'good', 'well', 'great', 'character',
'excellent', 'give', 'also', 'support', 'star', 'job']
...
Topic #10 without weights
['love', 'fall', 'song', 'wonderful', 'beautiful', 'music', 'heart', 'girl', 'would',
'watch', 'great', 'favorite', 'always', 'family', 'woman']
```

We depict some of the topics out of the 10 topics generated in the preceding output. You can leverage pyLDAvis now to visualize these topics in an interactive visualization. See Figure 7-18.

```
In [14]: pyLDAvis.sklearn.prepare(pos_nmf, ptvf_features, ptvf, R=15)
```

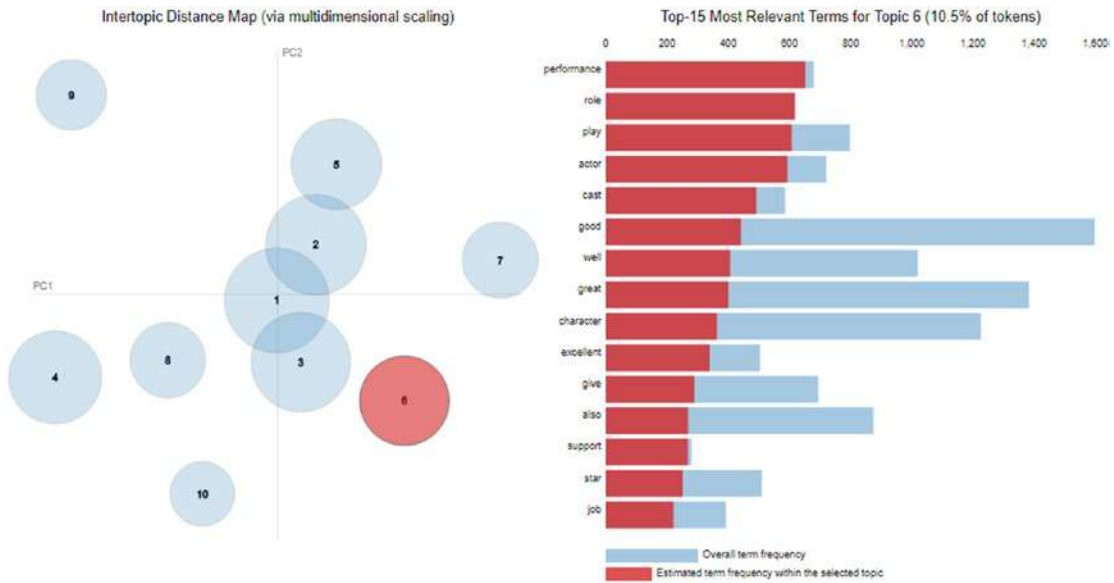

**Figure 7-18.** Visualizing topic models on positive sentiment movie reviews

The visualization depicted in Figure 7-18 shows us the 10 topics from positive movie reviews and we can see the top relevant terms for Topic 6 highlighted in the output. From the topics and the terms, we can see terms like *movie cast, actors, performance, play, characters, music, wonderful, good*, and so on have contributed toward positive sentiment in various topics. This is quite interesting and gives you a good insight into the components of the reviews that contribute toward positive sentiment of the reviews. This visualization is completely interactive if you are using the jupyter notebook and you can click on any of the bubbles representing topics in the Intertopic Distance Map on the left and see the most relevant terms in each of the topics in the right bar chart.

The plot on the left is rendered using Multi-dimensional Scaling (MDS). Similar topics should be close to one another and dissimilar topics should be far apart. The size of each topic bubble is based on the frequency of that topic and its components in the overall corpus.

The visualization on the right shows the top terms. When no topic is selected, it shows the top 15 most salient topics in the corpus. A term's saliency is defined as a measure of how frequently the term appears in the corpus and its distinguishing factor when used to distinguish between topics. When some topic is selected, the chart changes to show something similar to Figure 7-13, which shows the top 15 most relevant terms for that topic. The relevancy metric is controlled by  $\lambda$ , which can be changed based on a slider on top of the bar chart (refer to the notebook to interact with this). If you're interested in more mathematical theory behind these visualizations, you are encouraged to check out more details at <https://cran.r-project.org/web/packages/LDAvis/vignettes/details.pdf>, which is a vignette for the R package LDAvis, which has been ported to Python as pyLDAvis.

Let's now extract topics and run this same analysis on our negative sentiment reviews from the movie reviews dataset.

```
In [15]: # build topic model on negative sentiment review features
...: neg_nmf = NMF(n_components=10,
...:               random_state=42, alpha=0.1, l1_ratio=0.2)
...: neg_nmf.fit(ntvf_features)
...: # extract features and component weights
...: neg_feature_names = ntvf.get_feature_names()
...: neg_weights = neg_nmf.components_
...: # extract and display topics and their components
...: neg_topics = tmu.get_topics_terms_weights(neg_weights, neg_feature_names)
...: tmu.print_topics_udf(topics=neg_topics,
...:                     total_topics=total_topics,
...:                     num_terms=15,
...:                     display_weights=False)
```

Topic #1 without weights

```
['get', 'go', 'kill', 'guy', 'scene', 'take', 'end', 'back', 'start', 'around', 'look',
'one', 'thing', 'come', 'first']
```

Topic #2 without weights

```
['bad', 'movie', 'ever', 'acting', 'see', 'terrible', 'one', 'plot', 'effect', 'awful',
'not', 'even', 'make', 'horrible', 'special']
```

...

Topic #10 without weights

```
['waste', 'time', 'money', 'watch', 'minute', 'hour', 'movie', 'spend', 'not', 'life',
'save', 'even', 'worth', 'back', 'crap']
```

```
In [16]: pyLDavis.sklearn.prepare(neg_nmf, ntvf_features, ntvf, R=15)
```

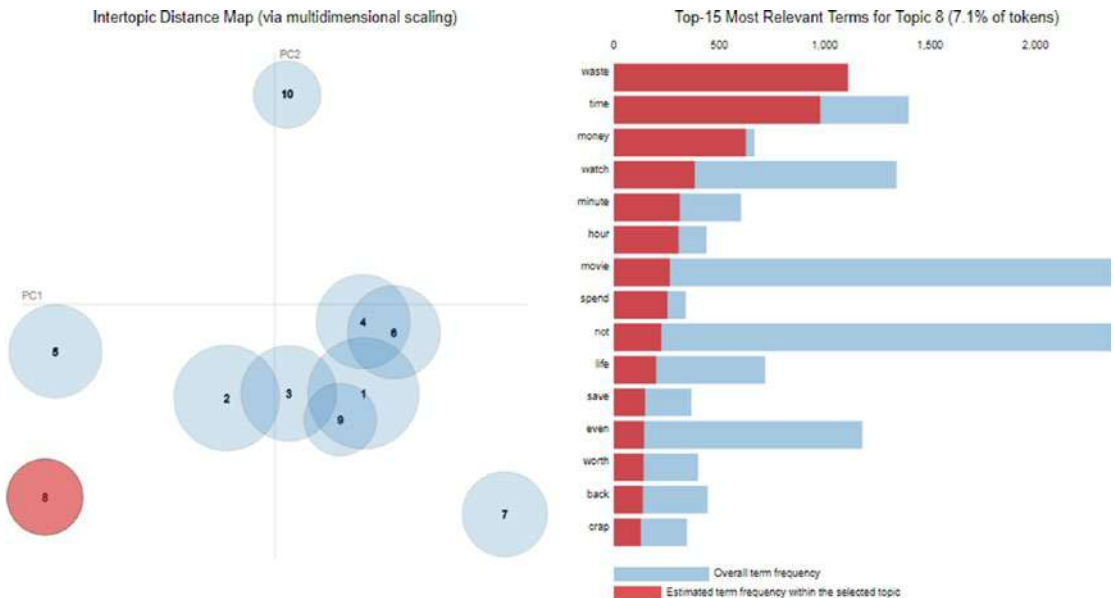

**Figure 7-19.** Visualizing topic models on positive sentiment movie reviews

The visualization depicted in Figure 7-19 shows us the 10 topics from negative movie reviews and we can see the top relevant terms for Topic 8 highlighted in the output. From the topics and the terms, we can see terms like *waste*, *time*, *money*, *crap*, *plot*, *terrible*, *acting*, and so on have contributed toward negative sentiment in various topics. Of course, there are high chances of overlap between topics from positive and negative sentiment reviews, but there will be distinguishable, distinct topics that further help us with interpretation and causal analysis.

## Summary

This case-study oriented chapter introduces the IMDb movie review dataset with the objective of predicting the sentiment of the reviews based on the textual content. We covered concepts and techniques from natural language processing (NLP), text analytics, Machine Learning and Deep Learning in this chapter. We covered multiple aspects from NLP including text pre-processing, normalization, feature engineering as well as text classification. Unsupervised learning techniques using sentiment lexicons like AFINN, SentiWordNet, and VADER were covered in extensive detail, to show how we can analyze sentiment in the absence of labeled training data, which is a very valid problem in today's organizations. Detailed workflow diagrams depicting text classification as a supervised Machine Learning problem helped us in relating NLP with Machine Learning so that we can use Machine Learning techniques and methodologies to solve this problem of predicting sentiment when labeled data is available.

The focus on supervised methods was two-fold. This included traditional Machine Learning approaches and models like Logistic Regression and Support Vector Machines and newer Deep Learning models including deep neural networks, RNNs, and LSTMs. Detailed concepts, workflows, hands-on examples and comparative analyses with multiple supervised models and different feature engineering techniques have been covered for the purpose of predicting sentiment from movie reviews with maximum model performance. The final section of this chapter covered a very important aspect of Machine Learning that is often neglected in our analyses. We looked at ways to analyze and interpret the cause of positive or negative sentiment. Analyzing and visualizing model interpretations and topic models have been covered with several examples, to give you a good insight into how you can re-use these frameworks on your own datasets. The frameworks and methodologies used in this chapter should be useful for you in tackling similar problems on your own text data in the future.

## CHAPTER 8



# Customer Segmentation and Effective Cross Selling

Money makes the world go round and in the current ecosystem of data intensive business practices, it is safe to claim that data also makes the world go round. A very important skill set for data scientists is to match the technical aspects of analytics with its business value, i.e., its monetary value. This can be done in a variety of ways and is very much dependent on the type of business and the data available. In the earlier chapters, we covered problems that can be framed as business problems (leveraging the CRISP-DM model) and linked to revenue generation. In this chapter we will directly focus on two very important problems that can directly have a positive impact on the revenue streams of businesses and establishments particularly from the retail domain. This chapter is also unique in the way that we address a different paradigm of Machine Learning algorithm altogether, focusing more on tasks pertaining to pattern recognition and unsupervised learning.

In this chapter, first we digress from our usual technical focus and try to gather some business and domain knowledge. This knowledge is quite important, as often this is the stumbling block for many data scientists in scenarios where a perfectly developed Machine Learning solution is not productionalized due to a lack of focus in the actual value obtained from the solution based on business demands. A firm grasp on the underlying business (and monetary) motivation helps the data scientists with defining the value aspect of their solutions and hence ensuring that they are deployed and contribute to generation of realizable value for their employers.

For achieving this objective, we will start with a retail transactions based dataset sourced from UCI Machine Learning Repository (<http://archive.ics.uci.edu/ml/datasets/online+retail>) and we will use this dataset to target two fairly simple but important problems. The detailed code, notebooks, and datasets used in this chapter are available in the respective directory for Chapter 8 in the GitHub repository at <https://github.com/dipanjanS/practical-machine-learning-with-python>.

- **Customer segmentation:** Customer segmentation is the problem of uncovering information about a firm's customer base, based on their interactions with the business. In most cases this interaction is in terms of their purchase behavior and patterns. We explore some of the ways in which this can be used.
- **Market basket analysis:** Market basket analysis is a method to gain insights into granular behavior of customers. This is helpful in devising strategies which uncovers deeper understanding of purchase decisions taken by the customers. This is interesting as a lot of times even the customer will be unaware of such biases or trends in their purchasing behavior.

## Online Retail Transactions Dataset

The online retail transactions dataset is available from the UCI Machine Learning Repository. We already used some datasets from this repository in our earlier chapters and this should underline the importance of this repository to the users. The dataset we will be using for our analysis is quite simple. Based on its description on the UCI web site, it contains all the transactions occurring between 01/12/2010 and 09/12/2011 for a UK-based and registered non-store online retail. From the web site, we also learn that the company sells unique all-occasion gift items and a lot of customers of the organization are wholesalers.

The last piece of information is particularly important as gives us an opportunity to explore purchase behaviors of large-scale customers instead of normal retail customers only. The dataset does not have any information that will help us distinguish between a wholesale purchase and a retail purchase. Before we get started, make sure you load the following dependencies.

```
import pandas as pd
import datetime
import math
import numpy as np
import matplotlib.pyplot as plt
import matplotlib.mlab as mlab

%matplotlib inline
```

---

■ **Note** We encourage you to check out the UCI Machine Learning Repository and the page for this particular dataset at <http://archive.ics.uci.edu/ml/datasets/online+retail>. On the web site, you can find some research papers that use the same dataset. We believe the papers along with the analysis performed in this chapter will make an interesting read for all our readers.

---

## Exploratory Data Analysis

We have always maintained that irrespective of the actual use case or the algorithm, we intend to implement the standard analysis workflow, which should always start with exploratory data analysis (EDA). So following the tradition, we will start with EDA on our dataset.

The first thing you should notice about the dataset is its format. Unlike most of the datasets that we have handled in this book the dataset is not in a CSV format and instead comes as an Excel file. In some other languages (or even frameworks) it could have been a cause of problem but with python and particularly pandas we don't face any such problem and we can read the dataset using the function `read_excel` provided by the pandas library. We also take a look at some of the lines in the dataset.

```
In [3]: cs_df = pd.read_excel(io=r'Online Retail.xlsx')
```

The few lines from the dataset gives us information about the attributes of the datasets, as shown in Figure 8-1.

	InvoiceNo	StockCode	Description	Quantity	InvoiceDate	UnitPrice	CustomerID	Country
0	536365	85123A	WHITE HANGING HEART T-LIGHT HOLDER	6	2010-12-01 08:26:00	2.55	17850.0	United Kingdom
1	536365	71053	WHITE METAL LANTERN	6	2010-12-01 08:26:00	3.39	17850.0	United Kingdom
2	536365	84406B	CREAM CUPID HEARTS COAT HANGER	8	2010-12-01 08:26:00	2.75	17850.0	United Kingdom
3	536365	84029G	KNITTED UNION FLAG HOT WATER BOTTLE	6	2010-12-01 08:26:00	3.39	17850.0	United Kingdom
4	536365	84029E	RED WOOLLY HOTTIE WHITE HEART.	6	2010-12-01 08:26:00	3.39	17850.0	United Kingdom

**Figure 8-1.** Sample transactions from the Retail Transactions dataset

The attributes of the dataset are easily identifiable from their names. We know right away what each of these fields might mean. For the sake of completeness, we include the description of each column here:

- **InvoiceNo:** A unique identifier for the invoice. An invoice number shared across rows means that those transactions were performed in a single invoice (multiple purchases).
- **StockCode:** Identifier for items contained in an invoice.
- **Description:** Textual description of each of the stock item.
- **Quantity:** The quantity of the item purchased.
- **InvoiceDate:** Date of purchase.
- **UnitPrice:** Value of each item.
- **CustomerID:** Identifier for customer making the purchase.
- **Country:** Country of customer.

Let's analyze this data and first determine which are the top countries the retailer is shipping its items to, and how are the volumes of sales for those countries.

```
In [5]: cs_df.Country.value_counts().reset_index().head(n=10)
```

```
Out[5]:
```

```

      index Country
0  United Kingdom  495478
1           Germany   9495
2           France   8557
3            EIRE   8196
4           Spain   2533
5  Netherlands   2371
6           Belgium  2069
7  Switzerland   2002
8           Portugal  1519
9           Australia  1259
```

This shows us that the bulk of ordering is taking place in its home country only which is not surprising. We also notice the odd country name EIRE, which is a little concerning. But a quick web search indicates that it is just an old name for Ireland, so no harm done! Interestingly, Australia is also in the top-ten list of sales by country.



Next we might be interested in how many unique customers the retailer is having and how do they stack up in the number of orders they make. We are also interested in knowing that what percentage of orders is made by the top 10 customers of the retailer. This information is interesting as it would tell us whether the user base of the firm is distributed relatively uniformly.

```
In [7]: cs_df.CustomerID.unique().shape
Out[7]: (4373,)
```

```
In [8]: (cs_df.CustomerID.value_counts()/sum(cs_df.CustomerID.value_counts()*100).
head(n=13).cumsum()
Out[8]:
17841.0    1.962249
14911.0    3.413228
14096.0    4.673708
12748.0    5.814728
14606.0    6.498553
15311.0    7.110850
14646.0    7.623350
13089.0    8.079807
13263.0    8.492020
14298.0    8.895138
15039.0    9.265809
14156.0    9.614850
18118.0    9.930462
Name: CustomerID, dtype: float64
```

This tells us that we have 4,373 unique customers but almost 10% of total sales are contributed by only 13 customers (based on the cumulative percentage aggregation in the preceding output). This is expected given the fact that we have both wholesale and retail customers. The next thing we want to determine is how many unique items the firm is selling and check whether we have equal number of descriptions for them.

```
In [9]: cs_df.StockCode.unique().shape
Out[9]: (4070,)
```

```
In [10]: cs_df.Description.unique().shape
Out[10]: (4224,)
```

We have a mismatch in the number of StockCode and Description, as we can see that item descriptions are more than stock code values, which means that we have multiple descriptions for some of the stock codes. Although this is not going to interfere with our analysis, we would like to dig a little deeper in this to find out what may have caused this issue or what kind of duplicated descriptions are present in the data.

```
cat_des_df = cs_df.groupby(["StockCode", "Description"]).count().reset_index()
cat_des_df.StockCode.value_counts()[cat_des_df.StockCode.value_counts()>1].reset_index().head()
```

index	StockCode
0	20713
1	23084
2	85175
3	21830
4	21181

```
In [13]: cs_df[cs_df['StockCode']]
...:      ==cat_des_df.StockCode.value_counts()[cat_des_df.StockCode.value_counts()>1].
...:      reset_index()['index'][6]]['Description'].unique()
Out[13]:
array(['MISTLETOE HEART WREATH CREAM', 'MISTLETOE HEART WREATH WHITE',
      'MISTLETOE HEART WREATH CREAM', '?', 'had been put aside', nan], dtype=object)
```

This gives the multiple descriptions for one of those items and we witness the simple ways in which data quality can be corrupted in any dataset. A simple spelling mistake can end up in reducing data quality and an erroneous analysis. In an enterprise-level scenario, dedicated people work toward restoring data quality manually over time. Since the intent of this section is to focus on customer segmentation, we will be skipping this tedious activity for now. Let's now verify the sanctity of the `Quantity` and `UnitPrice` attributes, as those are the attributes we will be using in our analysis.

```
In [14]: cs_df.Quantity.describe()
Out[14]:
count      541909.000000
mean         9.552250
std         218.081158
min        -80995.000000
25%          1.000000
50%          3.000000
75%         10.000000
max          80995.000000
Name: Quantity, dtype: float64
```

```
In [15]: cs_df.UnitPrice.describe()
Out[15]:
count      541909.000000
mean         4.611114
std          96.759853
min        -11062.060000
25%          1.250000
50%          2.080000
75%          4.130000
max          38970.000000
Name: UnitPrice, dtype: float64
```

We can observe from the preceding output that both of these attributes are having negative values, which may mean that we may have some return transactions in our data also. This scenario is quite common for any retailer but we need to handle these before we proceed to our analysis. These are some of the data quality issues we found in our dataset. In the real world, the datasets are generally messy and have considerable data quality issues, so it is always a good practice to explicitly verify information at hand before performing any kind of analysis. We encourage you to try and find similar issues with any dataset which you might want to analyze in the future.

# Customer Segmentation

Segmentation is the process of segregating any aggregated entity into separate parts or groups (segments). These parts may or may not share something common across them. Customer segmentation is similarly the process of dividing an organization's customer bases into different sections or segments based on various customer attributes. It is driven by the belief that customers are inherently different and this difference is exemplified by their behavior. A deep understanding of an organization's customer base and their behavior is often the focus of any customer segmentation project. The process of customer segmentation is based on the premise of finding differences among the customers' behavior and patterns. These differences can be on the basis of their buying behavior, their demographic information, their geographic information, their psychographic attributes, and so on.

## Objectives

Customer segmentation can help an organization in multitude of ways. Before we describe the various ways it can be done, we want to enumerate the major objectives and benefits behind the motivation for customer segmentation.

## Customer Understanding

One of the primary objectives of a customer segmentation process is a deeper understanding of a firm's customers and their attributes and behavior. These insights into the customer base can be used in different ways, as we will discuss shortly. But the information is useful by itself. One of the mostly widely accepted business paradigms is "know your customer" and a segmentation of the customer base allows for a perfect dissection of this paradigm. This understanding and its exploitation is what forms the basis of the other benefits of customer segmentation.

## Target Marketing

The most visible reason for customer segmentation is the ability to focus marketing efforts effectively and efficiently. If a firm knows the different segments of its customer base, it can devise better marketing campaigns which are tailor made for the segment. Consider the example of any travel company, if it knows that the major segments of its customers are the budget travelers and the luxury travelers, it can have two separate marketing campaigns for each of the group. One can focus on the higher value aspects of the company's offerings relevant to budget deals while the other campaign deals with luxurious offerings. Although the example seems quite trivial, the same logic can be extended in a number of ways to arrive at better marketing practices. A good segmentation model allows for better understanding of customer requirements and hence increases the chances of the success of any marketing campaign developed by the organization.

## Optimal Product Placement

A good customer segmentation strategy can also help the firm with developing or offering new products. This benefit is highly dependent on the way the segmentation process is leveraged. Consider a very simple example in which an online retailer finds out that a major section of its customers are buying makeup products together. This may prompt him to bundle those product together as a combined offering, which may increase sales margin for the retailer and make the buying process more streamlined for the customer.

## Finding Latent Customer Segments

A customer segmentation process helps the organization with knowing its customer base. An obvious side effect of any such practice is finding out which segment of customers it might be missing. This can help in identifying untapped customer segments by focused on marketing campaigns or new product development.

## Higher Revenue

This is the most obvious requirement of any customer segmentation project. The reason being that customer segmentation can lead to higher revenue due to the combined effects of all the advantages identified in this section.

## Strategies

The easy answer to the question of “How to do customer segmentation?” would be “In any way you deem fit” and it would be a perfectly acceptable answer. The reason this is the right answer, is because of the original definition of customer segmentation. It is just a way of differentiating between the customers. It can be as simple as making groups of customers based on age groups or other attributes using a manual process or as complex as using a sophisticated algorithm for finding out those segments in an automated fashion. Since our book is all about Machine Learning, we describe how customer segmentation can be translated into a core Machine Learning task. The detailed code for this section is available in the notebook titled `Customer Segmentation.ipynb`.

## Clustering

We are dealing with an unlabeled, unsupervised transactional dataset from which we want to find out customer segments. Thus, the most obvious method to perform customer segmentation is using unsupervised Machine Learning methods like clustering. Hence, this will be the method that we use for customer segmentation in this chapter. The method is as simple as collecting as much data about the customers as possible in the form of *features* or *attributes* and then finding out the different clusters that can be obtained from that data. Finally, we can find traits of customer segments by analyzing the characteristics of the clusters.

## Exploratory Data Analysis

Using exploratory data analysis is another way of finding out customer segments. This is usually done by analysts who have a good knowledge about the domain relevant to both products and customers. It can be done flexibly to include the top decision points in an analysis. For example, finding out the range of spends by customers will give rise to customer segments based on spends. We can proceed likewise on important attributes of customers until we get segments of customer that have interesting characteristics.

## Clustering vs. Customer Segmentation

In our use case, we will be using a clustering based model to find out interesting segments of customers. Before we go on to modify our data for the model there is an interesting point we would like to clarify. A lot of people think that clustering is equivalent to customer segmentation. Although it is true that clustering is one of the most suitable techniques for segmentation, it is not the only technique. Besides this, it is just a method that is “applied” to extract *segments*.

Customer segmentation is just the task of segmenting customers. It can be solved in several ways and it need not always be a complex model. Clustering provides a mathematical framework which can be leveraged for finding out such segment boundaries in the data. Clustering is especially useful when we have a lot of attributes about the customer on which we can make different segments. Also, often it is observed that a clustering-based segmentation will be superior to an arbitrary segmentation process and it will often encompass the segments that can be devised using such an arbitrary process.

## Clustering Strategy

Now that we have some information about what customer segmentation is, various strategies and how it can be useful, we can start with the process of finding out customer segments in our online retail dataset. The dataset that we have consists of only the sales transactions of the customers and no other information about them, i.e., no other additional attributes. Usually in larger organizations we will usually have more attributes of information about the customers that can help in clustering. However, it will be interesting and definitely a challenge to work with this limited attribute dataset! So we will use a **RFM**—Recency, Frequency and Monetary Value—based model of customer value for finding our customer segments.

## RFM Model for Customer Value

The RFM model is a popular model in marketing and customer segmentation for determining a customer's value. The RFM model will take the transactions of a customer and calculate three important informational attributes about each customer:

- **Recency:** The value of how recently a customer purchased at the establishment
- **Frequency:** How frequent the customer's transactions are at the establishment
- **Monetary value:** The dollar (or pounds in our case) value of all the transactions that the customer made at the establishment

A combination of these three values can be used to assign a value to the customer. We can directly think of some desirable segments that we would want on such model. For example, a high value customer is one who buys frequently, just bought something recently, and spends a high amount whenever he buys or shops!

## Data Cleaning

We hinted in the “Exploratory Data Analysis” section about the return transactions that we have in our dataset. Before proceeding with our analysis workflow, we will find out all such transactions and remove them. Another possibility is to remove the matching buying transactions also from the dataset. But we will assume that those transactions are still important hence we will keep them intact. Another data cleaning operation is to separate transactions for a particular geographical region only, as we don't want data from Germany's customers to affect the analysis for another country's customers. The following snippet of code achieves both these tasks. We focus on UK customers, which are notably the largest segment (based on country!).

```
In [16]: # Separate data for one geography
...: cs_df = cs_df[cs_df.Country == 'United Kingdom']
...:
...: # Separate attribute for total amount
...: cs_df['amount'] = cs_df.Quantity*cs_df.UnitPrice
...:
...: # Remove negative or return transactions
```

```

...: cs_df = cs_df[~(cs_df.amount<0)]
...: cs_df.head()
...:
Out[16]:
  InvoiceNo StockCode      Description  Quantity \
0   536365   85123A  WHITE HANGING HEART T-LIGHT HOLDER      6
1   536365    71053           WHITE METAL LANTERN      6
2   536365   84406B    CREAM CUPID HEARTS COAT HANGER      8
3   536365   84029G  KNITTED UNION FLAG HOT WATER BOTTLE      6
4   536365   84029E    RED WOOLLY HOTTIE WHITE HEART.      6

      InvoiceDate  UnitPrice  CustomerID      Country  amount
0 2010-12-01 08:26:00      2.55    17850.0  United Kingdom    15.30
1 2010-12-01 08:26:00      3.39    17850.0  United Kingdom    20.34
2 2010-12-01 08:26:00      2.75    17850.0  United Kingdom    22.00
3 2010-12-01 08:26:00      3.39    17850.0  United Kingdom    20.34
4 2010-12-01 08:26:00      3.39    17850.0  United Kingdom    20.34

```

The data now has only buying transactions from United Kingdom. We will now remove all the transactions that have a missing value for the CustomerID field as all our subsequent transactions will be based on the customer entities.

```

In [17]: cs_df = cs_df[~(cs_df.CustomerID.isnull())]
In [18]: cs_df.shape
Out[18]: (354345, 9)

```

The next step is creating the recency, frequency, and monetary value features for each of the customers that exist in our dataset.

## Recency

To create the recency feature variable, we need to decide the reference date for our analysis. For our use case, we will define the reference date as one day after the last transaction in our dataset.

```

In [19]: reference_date = cs_df.InvoiceDate.max()
...: reference_date = reference_date + datetime.timedelta(days = 1)
...: reference_date
Out[20]: Timestamp('2011-12-10 12:49:00')

```

We will construct the recency variable as the number of days before the reference date when a customer last made a purchase. The following snippet of code will create this variable for us.

```

In [21]: cs_df['days_since_last_purchase'] = reference_date - cs_df.InvoiceDate
...: cs_df['days_since_last_purchase_num'] = cs_df['days_since_last_purchase'].
astype('timedelta64[D]')

In [22]: customer_history_df = cs_df.groupby("CustomerID").min().reset_index()
[['CustomerID', 'days_since_last_purchase_num']]
...: customer_history_df.rename(columns={'days_since_last_purchase_num': 'recency'},
inplace=True)

```

Before we proceed, let's examine how the distribution of customer recency looks for our data (see Figure 8-2).

```
x = customer_history_df.recency
mu = np.mean(customer_history_df.recency)
sigma = math.sqrt(np.var(customer_history_df.recency))
n, bins, patches = plt.hist(x, 1000, facecolor='green', alpha=0.75)

# add a 'best fit' line
y = mlab.normpdf( bins, mu, sigma)
l = plt.plot(bins, y, 'r--', linewidth=2)

plt.xlabel('Recency in days')
plt.ylabel('Number of transactions')
plt.title(r'$\mathrm{Histogram\ of\ sales\ recency}\ $')
plt.grid(True)
```

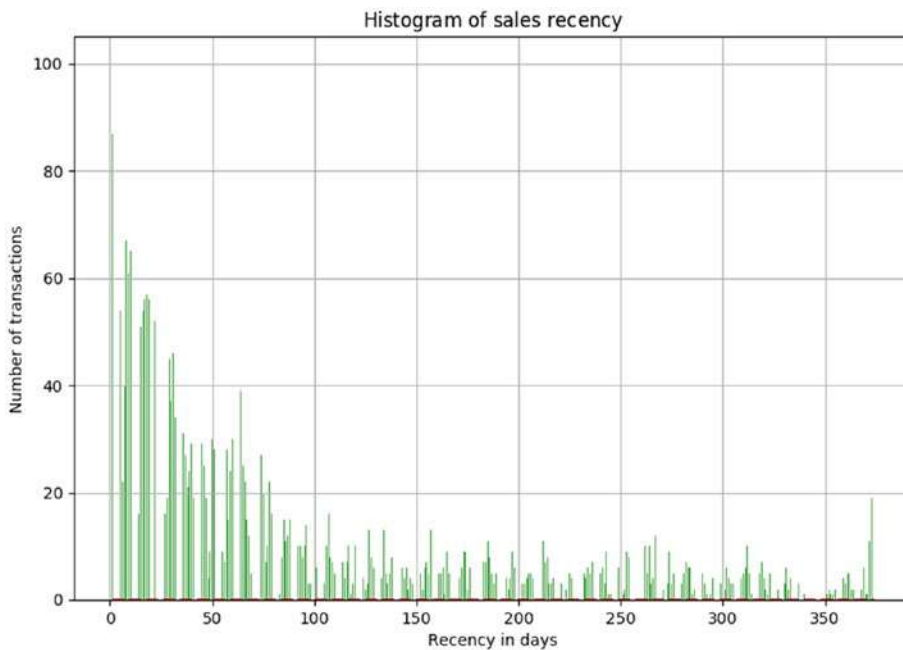

**Figure 8-2.** Distribution of sales recency

The histogram in Figure 8-2 tells us that we have skewed distribution of sales recency with a much higher number of frequent transactions and a fairly uniform number of less recent transactions.

## Frequency and Monetary Value

Using similar methods, we can create a frequency and monetary value variable for our dataset. We will create these variables separately and then merge all the dataframes to arrive at the customer value dataset. We will perform our clustering-based customer segmentation on this dataframe. The following snippet will create both these variables and the final merged dataframe.

```
In [29]: customer_monetary_val = cs_df[['CustomerID',
                                         'amount']],groupby("CustomerID").sum().reset_index()
...: customer_history_df = customer_history_df.merge(customer_monetary_val, how='outer')
...: customer_history_df.amount = customer_history_df.amount+0.001
...:
...: customer_freq = cs_df[['CustomerID',
                              'amount']],groupby("CustomerID").count().reset_index()
...: customer_freq.rename(columns={'amount':'frequency'},inplace=True)
...: customer_history_df = customer_history_df.merge(customer_freq, how='outer')
```

The input dataframe for clustering will look like the dataframe depicted in Figure 8-3. Notice that we have added a small figure 0.001 to the customer monetary value, as we will be transforming our values to the log scale and presence of zeroes in our data may lead to an error.

	CustomerID	recency	amount	frequency
0	12346.0	326.0	77183.601	1
1	12747.0	2.0	4196.011	103
2	12748.0	1.0	33719.731	4596
3	12749.0	4.0	4090.881	199
4	12820.0	3.0	942.341	59

**Figure 8-3.** Customer value dataframe

## Data Preprocessing

Once we have created our customer value dataframe, we will perform some preprocessing on the data. For our clustering, we will be using the *K-means clustering* algorithm, which we discussed in the earlier chapters. One of the requirements for proper functioning of the algorithm is the mean centering of the variable values. Mean centering of a variable value means that we will replace the actual value of the variable with a standardized value, so that the variable has a mean of 1 and variance of 0. This ensures that all the variables are in the same range and the difference in ranges of values doesn't cause the algorithm to not perform well. This is akin to feature scaling.

Another problem that you can investigate about is the huge range of values each variable can take. This problem is particularly noticeable for the monetary amount variable. To take care of this problem, we will transform all the variables on the log scale. This transformation, along with the standardization, will ensure that the input to our algorithm is a homogenous set of scaled and transformed values.

An important point about the data preprocessing step is that sometimes we need it to be reversible. In our case, we will have the clustering results in terms of the log transformed and scaled variable. But to make inferences in terms of the original data, we will need to reverse transform all the variable so that we get back the actual RFM figures. This can be done by using the preprocessing capabilities of Python.

```
In [30]: from sklearn import preprocessing
...: import math
...: customer_history_df['recency_log'] = customer_history_df['recency'].apply(math.log)
...: customer_history_df['frequency_log'] = customer_history_df['frequency'].apply(math.log)
...: customer_history_df['amount_log'] = customer_history_df['amount'].apply(math.log)
...: feature_vector = ['amount_log', 'recency_log', 'frequency_log']
```



```

...: X = customer_history_df[feature_vector].as_matrix()
...: scaler = preprocessing.StandardScaler().fit(X)
...: X_scaled = scaler.transform(X)

```

The previous code snippet will create a log valued and mean centered version of our dataset. We can visualize the results of our preprocessing by inspecting the variable with the widest range of values. The following code snippet will help us visualize this.

```

In [31]: x = customer_history_df.amount_log
...: n, bins, patches = plt.hist(x, 1000, facecolor='green', alpha=0.75)
...: plt.xlabel('Log of Sales Amount')
...: plt.ylabel('Probability')
...: plt.title(r'\mathrm{Histogram\ of\ Log\ transformed\ Customer\ Monetary\ value}\ $')
...: plt.grid(True)
...: plt.show()

```

The resulting graph is a distribution resembling normal distribution with mean 0 and variance of 1, as clearly depicted in Figure 8-4.

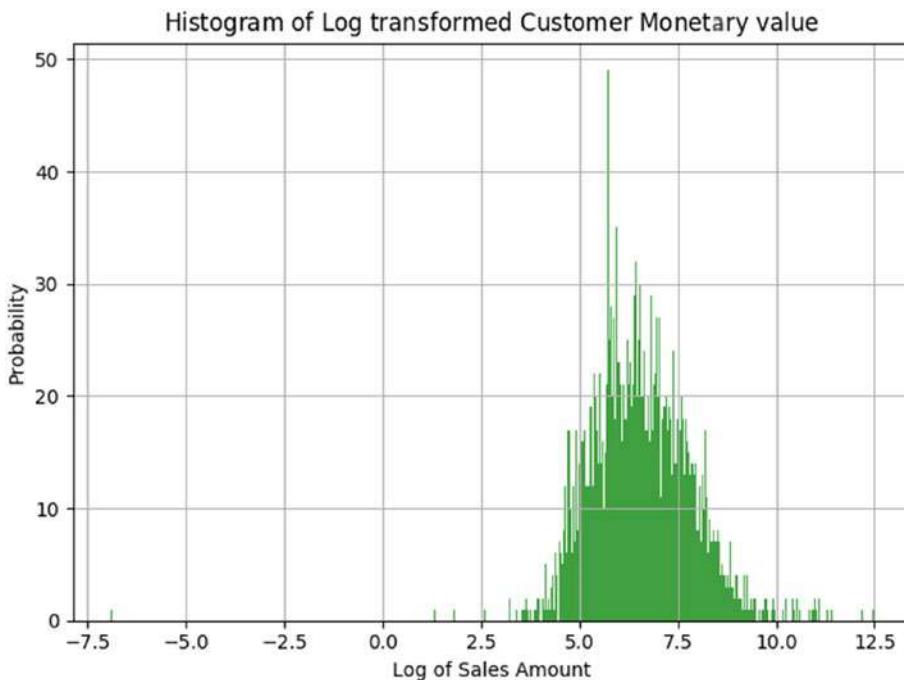

**Figure 8-4.** Scaled and log transformed sales amount

Let's try to visualize our three main features (R, F, and M) on a three-dimensional plot to see if we can understand any interesting patterns that the data distribution is showing.

```
from mpl_toolkits.mplot3d import Axes3D

fig = plt.figure(figsize=(8, 6))
ax = fig.add_subplot(111, projection='3d')

xs = customer_history_df.recency_log
ys = customer_history_df.frequency_log
zs = customer_history_df.amount_log
ax.scatter(xs, ys, zs, s=5)

ax.set_xlabel('Recency')
ax.set_ylabel('Frequency')
ax.set_zlabel('Monetary')
```

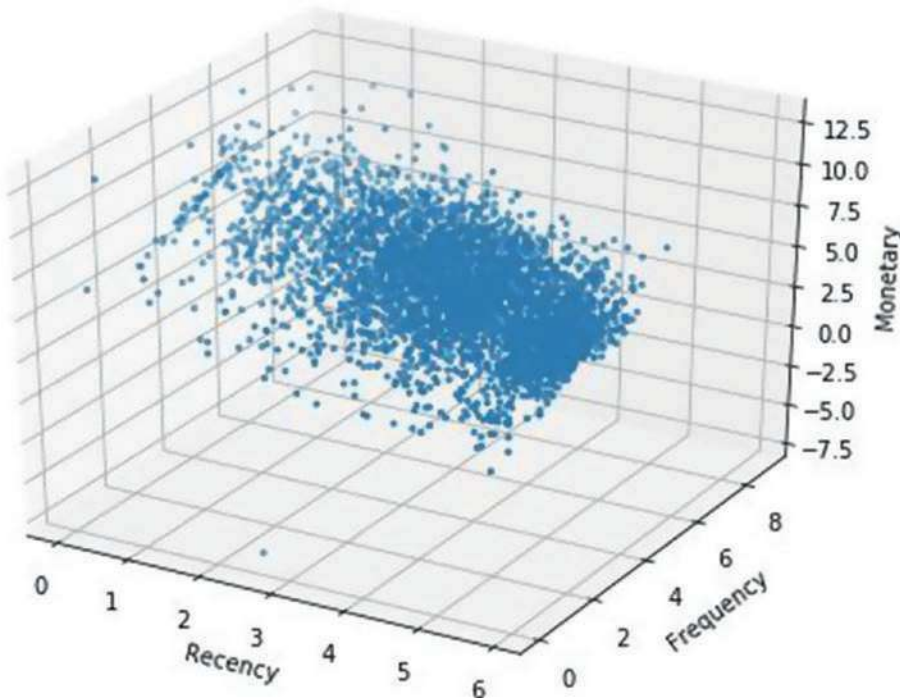

**Figure 8-5.** Customer value dataframe

The obvious patterns we can see from the plot in Figure 8-5 is that people who buy with a higher frequency and more recency tend to spend more based on the increasing trend in Monetary value with a corresponding increasing and decreasing trend for Frequency and Recency, respectively. Do you notice any other interesting patterns?

## Clustering for Segments

We will be using the K-means clustering algorithm for finding out clusters (or segments in our data). It is one of the simplest clustering algorithms that we can employ and hence it is widely used in practice. We will give you a brief primer of the algorithm before we go on to using the same, for finding segments in our data.

### K-Means Clustering

The K-means clustering belongs to the partition based\centroid based clustering family of algorithms. The steps that happen in the K-means algorithm for partitioning the data are as given follows:

1. The algorithm starts with random point initializations of the required number of centers. The “K” in K-means stands for the number of clusters.
2. In the next step, each of the data point is assigned to the center closest to it. The distance metric used in K-means clustering is normal Euclidian distance.
3. Once the data points are assigned, the centers are recalculated by averaging the dimensions of the points belonging to the cluster.
4. The process is repeated with new centers until we reach a point where the assignments become stable. In this case, the algorithm terminates.

We will adapt the code given in the `scikit-learn` documentation at [http://scikit-learn.org/stable/auto\\_examples/cluster/plot\\_kmeans\\_silhouette\\_analysis.html](http://scikit-learn.org/stable/auto_examples/cluster/plot_kmeans_silhouette_analysis.html) and use the silhouette score for finding out the optimal number of clusters during our clustering process. We leave it as an exercise for you to adapt the code and create the visualization in Figure 8-6. You are encouraged to modify the code in the documentation to not only build the visualization, but also to capture the centers and the silhouette score of each cluster in a dictionary, as we will need to refer to those for performing our analysis of the customer segments obtained. Of course, in case you find it overwhelming, you can always refer to the detailed code snippet in the `Customer Segmentation.ipynb` notebook.

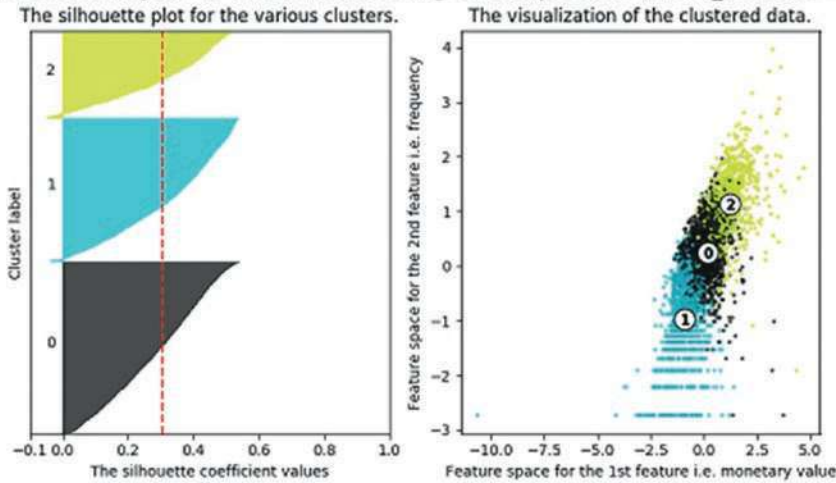
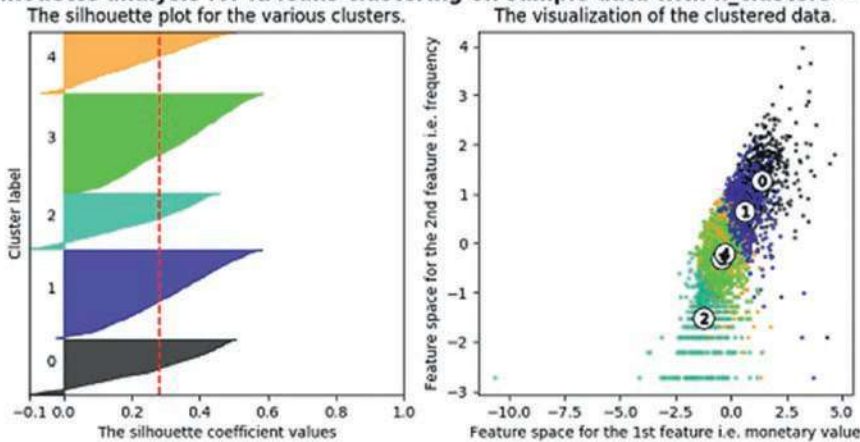
**Silhouette analysis for KMeans clustering on sample data with n\_clusters = 3****Silhouette analysis for KMeans clustering on sample data with n\_clusters = 5**

**Figure 8-6.** Silhouette analysis with three and five clusters

In the visualization depicted in Figure 8-6, we plotted the silhouette score of each cluster along with the center of each of the cluster discovered. We will use this information in the next section on cluster analysis. Although we have to keep in mind that in several cases and scenarios, sometimes we may have to drop the mathematical explanation given by the algorithm and look at the business relevance of the results obtained.

## Cluster Analysis

Before we proceed to the analysis of clusters such obtained, let's look at the cluster center values after retransforming them to normal values from the log and scaled version. The following code helps us convert the center values to the reversed transformed values.

```
In [38]: for i in range(3,6,2):
...:     print("for {} number of clusters".format(i))
```

```

...: cent_transformed = scaler.inverse_transform(cluster_centers[i]['cluster_center'])
...: print(pd.DataFrame(np.exp(cent_transformed),columns=feature_vector))
...: print("Silhouette score for cluster {} is {}".format(i,
...:                                     cluster_centers[i]['silhouette_score']))
...: print()

for 3 number of clusters
  amount_log  recency_log  frequency_log
0  843.937271    44.083222    53.920633
1  221.236034   121.766072    10.668661
2  3159.294272    7.196647    177.789098
Silhouette score for cluster 3 is 0.30437444714898737

for 5 number of clusters
  amount_log  recency_log  frequency_log
0  3905.544371    5.627973    214.465989
1  1502.519606   46.880212    92.306262
2  142.867249   126.546751    5.147370
3  408.235418   139.056216    25.530424
4  464.371885   13.386419    29.581298
Silhouette score for cluster 5 is 0.27958641427323727

```

When we look at the results of the clustering process, we can infer some interesting insights. Consider the three-cluster configuration and try to understand the following insights.

- We get three clusters with stark differences in the Monetary value of the customer.
- Cluster 2 is the cluster of high value customer who shops frequently and is certainly an important segment for each business.
- In the similar way we obtain customer groups with low and medium spends in clusters with labels 1 and 0, respectively.
- Frequency and Recency correlate perfectly to the Monetary value based on the trend we talked about in Figure 8-3 (High Monetary-Low Recency-High Frequency).

The five-cluster configuration results are more surprising! When we go looking for more segments, we find out that our high valued customer base is comprised of two subgroups:

- Those who shop often and with high amount (represented by cluster 0).
- Those who have a decent spend but are not as frequent (represented by cluster 1).

This is in direct conflict with the result we obtain from the silhouette score matrix which says the five-cluster segments are less optimal than the three cluster segments. Of course, remember you must not strictly go after mathematical metrics all the time and think about the business aspects too. Besides this, there could be more insights that are uncovered as you visualize the data based on these segments which might prove that in-fact the three-cluster segmentation was far better. For instance, if you check the right-side plot in Figure 8-6, you can see that segments with five clusters have too much overlap among them, as compared to segments with three clusters.

## Cluster Descriptions

On the basis of eyeballing the cluster centers, we can figure out that we have a good difference in the customer value in the segments as defined in terms of recency, amount and frequency. To further drill down on this point and find out the quality of these difference, we can label our data with the corresponding cluster label and then visualize these differences. We will do this visualization for probably one of the most important customer value indicators, the total dollar value sales.

To arrive at such distinction based summary computations, we will first label each data row in our customer summary dataframe with the corresponding label as returned by our clustering algorithm. Note that you have to modify the code you are using if you want to try a different configuration of let's say two or four clusters. We will have to make changes so that we capture the labels for each different cluster configuration. We encourage you to try other cluster configurations to see if you get even better segments! The following code will extract the clustering label and attach it with our customer summary dataframe.

```
labels = cluster_centers[5]['labels']
customer_history_df['num_cluster5_labels'] = labels
labels = cluster_centers[3]['labels']
customer_history_df['num_cluster3_labels'] = labels
```

Once we have the labels assigned to each of the customers, our task is simple. Now we want to find out how the summary of customer in each group is varying. If we can visualize that information we will be able to find out the differences in the clusters of customers and we can modify our strategy on the basis of those differences. We have used a lot of `matplotlib` and `seaborn` so far; we will be using `plotly` in this section for creating some interactive plots that you can play around with in your jupyter notebook!

---

■ **Note** While `plotly` provides excellent interactive visualizations in jupyter notebooks, you might come across some notebook rendering issues that come up as popups when you open the notebook. To fix this problem, upgrade your `nbformat` library by running the `conda update nbformat` command and re-open the notebook. The problem should disappear.

---

The following code leverages `plotly` and will take the cluster labels we got for the configuration of five clusters and create boxplots that will show how the median, minimum, maximum, highest, and lowest values are varying in the five groups. Note that we want to avoid the extremely high outlier values of each group, as they will interfere in making a good observation (due to noise) around the central tendencies of each cluster. So we will restrict the data such that only data points which are less than 0.8th percentile of the cluster is used. This will give us good information about the majority of the users in that cluster segment. The following code will help us create this plot for the total sales value.

```
import plotly as py
import plotly.graph_objs as go
py.offline.init_notebook_mode()

x_data = ['Cluster 1', 'Cluster 2', 'Cluster 3', 'Cluster 4', 'Cluster 5']
cutoff_quantile = 80
field_to_plot = 'amount'

y0=customer_history_df[customer_history_df['num_cluster5_labels']==0][field_to_plot].values
y0 = y0[y0<np.percentile(y0, cutoff_quantile)]
y1=customer_history_df[customer_history_df['num_cluster5_labels']==1][field_to_plot].values
```

```

y1 = y1[y1<np.percentile(y1, cutoff_quantile)]
y2=customer_history_df[customer_history_df['num_cluster5_labels']==2][field_to_plot].values
y2 = y2[y2<np.percentile(y2, cutoff_quantile)]
y3=customer_history_df[customer_history_df['num_cluster5_labels']==3][field_to_plot].values
y3 = y3[y3<np.percentile(y3, cutoff_quantile)]
y4=customer_history_df[customer_history_df['num_cluster5_labels']==4][field_to_plot].values
y4 = y4[y4<np.percentile(y4, cutoff_quantile)]
y_data = [y0,y1,y2,y3,y4]

colors = ['rgba(93, 164, 214, 0.5)', 'rgba(255, 144, 14, 0.5)', 'rgba(44, 160, 101, 0.5)',
'rgba(255, 65, 54, 0.5)', 'rgba(207, 114, 255, 0.5)', 'rgba(127, 96, 0, 0.5)']
traces = []

for xd, yd, cls in zip(x_data, y_data, colors):
    traces.append(go.Box(
        y=yd,      name=xd,      boxpoints=False,
        jitter=0.5,      whiskerwidth=0.2,
        fillcolor=cls,      marker=dict(size=2,),
        line=dict(width=1), ))

layout = go.Layout(
    title='Difference in sales {} from cluster to cluster'.format(field_to_plot),
    yaxis=dict(
        autorange=True,      showgrid=True,
        zeroline=True,      dtick=1000,
        gridcolor='black',      gridwidth=0.1,
        zerolinecolor='rgb(255, 255, 255)',
        zerolinewidth=2,      ),
    margin=dict(l=40,r=30, b=80, t=100,      ),
    paper_bgcolor='white',      plot_bgcolor='white',      showlegend=False
)

fig = go.Figure(data=traces, layout=layout)
py.offline.iplot(fig)

```

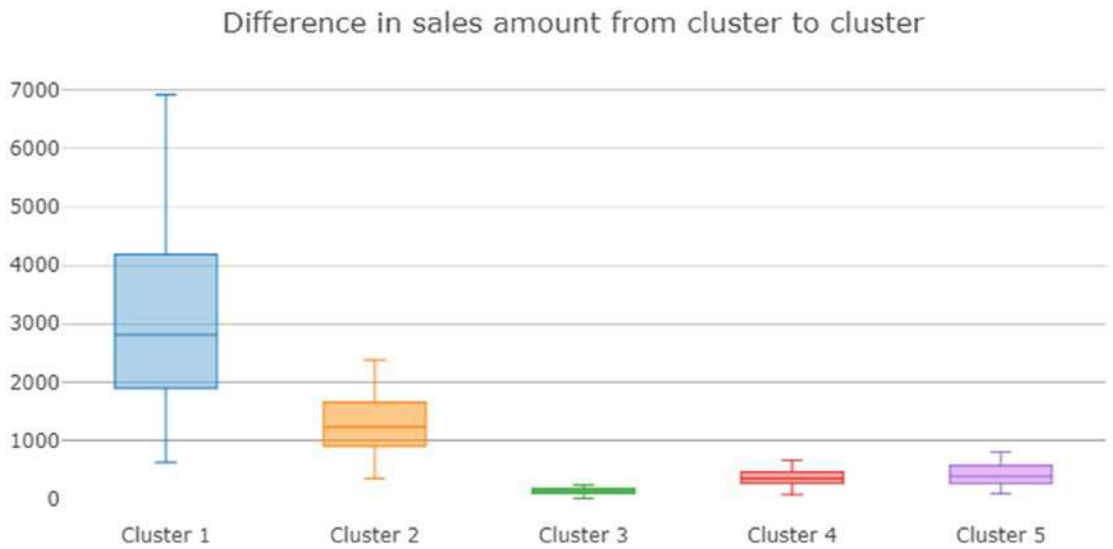
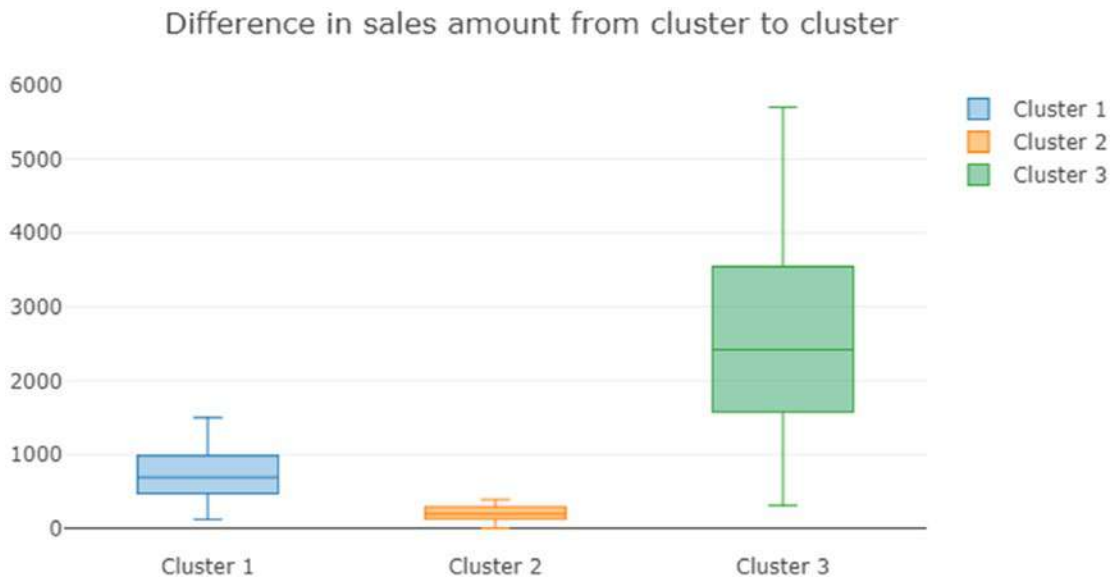

**Figure 8-7.** Difference in sales amount values across the five segments

Let's also take a look at the plot that is generated as a result of this code snippet. In Figure 8-7 we can see that the Clusters 1 and 2 have a higher average sales amount, thus being the highest spenders. Although we don't see much difference in the sales values of Clusters 4 and 5, we do see a markedly smaller sales amount in Cluster 3. This gives us an indication that we can merge the candidates of Clusters 4 and 5 together, at least on the basis of sales amount. You can plot similar figures for recency and frequency also to figure out differences in the cluster on the basis of those values. Detailed code and visualizations are present in the notebook for three- and five-cluster based segments. Plotly enables us to interact with the plots to see the central tendency values in each boxplot in the notebook. We show the difference in sales amount across three segments based on the three-cluster configuration just so you can compare it with Figure 8-7.

The detailed visualization is shown in Figure 8-8, which talks about difference in the sales/revenue across the three segments. It is clear that this is much more distinguishable and we also have lesser overlap as compared to Figure 8-7 where Clusters 4 and 5 were very similar. This doesn't mean that the previous method was wrong; it's just one of the dimensions where some segments were similar to each other.





**Figure 8-8.** Difference in sales amount values across the three segments

We can further improve the quality of clustering by adding relevant features to the dataset that we have created. Often firms will buy data regarding their customers from external data vendors and use it to enhance the segmentation process. We had a limitation of only having around a year worth of transaction data but even a mid-size organization may have multiple years of transaction data which can improve the results. Another dimension to explore can be trying out different algorithms for performing the segmentation for instance hierarchical clustering, which we explored in some of the earlier chapters. A good segmentation process will encompass all these avenues to arrive at optimal segments that provide valuable insight. We encourage you to get creative with the process and build your own examples.

The important caveat from this analysis is that when it comes to correlating the actual value of results with the mathematical metrics we cannot always rely on the metrics. We need to include this habit of including business metrics and domain insights in our modeling process as often times this becomes the difference between an implemented high value project and a forgotten data-focused solution. Once we obtain these results, we can further discuss them with the marketing team of the organization to come up with appropriate practices for each of the segment identified.

## Cross Selling

What is cross selling? In the simplest terms, cross selling is the ability to sell more products to a customer by analyzing the customer's shopping trends as well as general shopping trends and patterns which are in common with the customer's shopping patterns. This simple definition captures the essential idea of cross selling, but it is not as descriptive as we would like it to be.

We will illustrate the idea with an example. Say we are concerned about our health (which everyone should be) and decide to buy a protein supplement on our favorite e-commerce site. In most scenarios, the moment you get to your product page, you will have a section that will tell you other products that you can buy along with the product(s) of your choice. See Figure 8-9.

## Frequently bought together



Figure 8-9. Cross selling example

More often than not, these recommended products would be very appealing. For example, if I am in the market for a protein supplement it will definitely be a good idea for me to buy a vitamin supplement too. The retailer will often offer you a bundle of products with some attractive offer and it is highly likely that we will end up buying the bundled products instead of just the original item. This is the simple but powerful concept of cross selling. We research the customer transactions and find out potential additions to the customer's original needs and offer it to the customer as a suggestion in the hope and intent that they buy them benefiting both the customer as well as the retail establishment.

Cross selling is ubiquitous in both the online and offline retail worlds. The simplicity and the effectiveness of the idea make it an essential and powerful marketing tool for all types of retailers. The idea of cross selling can be extended to any organization, irrespective of whether it is an online or offline retailer or whether it is selling its products to the end users of whole sellers.

In this section, we explore *association rule-mining*, a powerful technique that can be used for cross selling, then we illustrate the concept of market basket analysis for a toy dataset, and finally we apply the same concepts to our retail transactions dataset.

## Market Basket Analysis with Association Rule-Mining

Before we go on to understand how to generate the association rules from our transactional data, let's try to understand how we will use those rules. A famous story in data analytics circles is the story of "Beer and Diapers". The basic crux of the story is the concept that a major retailer upon analyzing their customer transaction behavior discovered a strong association between sales of beer and diapers. The retailer was able to exploit this association by moving the beer section close to the diapers section leading to higher sales volume (The origins of the story may have some fact but the whole concept is debatable. We encourage you to go through the discussion at <http://www.dssresources.com/newsletters/66.php> for learning more about this story).

Although the beer and diaper story may or may not have been a myth, the concept of finding sales association in customer behavior is an important and inspiring one. Suppose we can mathematically capture the significance of these associations, then it would be a good idea to try and exploit the rules which are likely to be correct. The whole concept of association rule-mining is based on the concept that customer purchase behavior has a pattern which can be exploited for selling more items to the customer in the future. An association rule usually has the structure as depicted in this equation:

$$\{item_1, item_2, item_3 \rightarrow item_k\}$$

This rule can be read in the obvious manner that when the customer bought items on the (left hand side) LHS of the rule he is likely to buy the  $item_k$ . In the later sections, we define mathematical metrics that will capture the strength of such rules.

We can use these rules in a variety of ways. The most obvious way to use these rules is to develop bundles of products which make it convenient for the customer to buy these items together. Another way to use these rules is to bundle products along with some discounts for other relevant products in the bundle, hence ensuring that the customer becomes more likely to buy more items. Some unlikely ways to use association rules is for designing a better web site navigational structure, intrusion detection, bioinformatics, and so on.

## Association Rule-Mining Basics

Before proceeding to explore the association rules in our dataset, we will go through some essential concepts for association rule-mining. These terms and concepts will help you in the later analysis and also in understanding the rules that the algorithm will generate. Consider Table 8-1 with some toy transaction data.

**Table 8-1.** Example of a Transaction Set

Trans.ID	Items
1	{milk, bread}
2	{butter}
3	{beer, diaper}
4	{milk, bread, butter}
5	{bread}

Each row in the table consists of a transaction. For example, the customer bought milk and bread in the first transaction. Following are some vital concepts pertaining to association rule-mining.

- **Itemset:** Itemset is just a collection of one or more items that occur together in a transaction. For example, here {milk, bread} is example of an itemset.
- **Support:** Support is defined as number of times an itemset appears in the dataset. Mathematically it is defined as:

$$supp(\{beer, diaper\}) = \frac{\text{number of transactions with beer and diaper}}{\text{total transactions}}$$

In the previous example, support (beer, diaper) = 1/5 = 0.2.

- **Confidence:** Confidence is a measure of the times the number of times a rule is found to exist in the dataset. For a rule which states {beer → diaper} the confidence is mathematically defined as:

$$confidence(\{beer, diaper\}) = \frac{supp(beer \text{ and } diaper)}{supp(beer)}$$

- **Lift:** Lift of the rule is defined as the ratio of observed support to the support expected in the case the elements of the rule were independent. For the previous set of transactions if the rule is defined as  $\{X \rightarrow Y\}$ , then the lift of the rule is defined as:

$$lift(X \rightarrow Y) = \frac{supp(X \cup Y)}{(supp(X) * supp(Y))}$$

- **Frequent itemset:** Frequent itemsets are itemsets whose support is greater than a user defined support threshold.

## FP Growth

The most famous algorithm for association rule-mining is the Apriori algorithm, for which you will find a lot of code and resources on the web and in standard data mining literature. However, here we will use a different and more efficient algorithm, the FP growth algorithm for finding our association rules. The major bottleneck in any association rule-mining algorithm is the generation of frequent itemsets. If the transaction dataset is having  $k$  unique products, then potentially we have  $2^k$  possible itemsets. The Apriori algorithm will first generate these itemsets and then proceed to finding the frequent itemsets.

This limitation is a huge performance bottleneck as even for around 100 unique products the possible number of itemsets is huge. This limitation makes the Apriori algorithm prohibitively computationally expensive. The FP growth algorithm is superior to Apriori algorithm as it doesn't need to generate all the candidate itemsets. The algorithm uses a special data structure that helps it retain itemset association information. An example of the data structure is depicted in Figure 8-10.

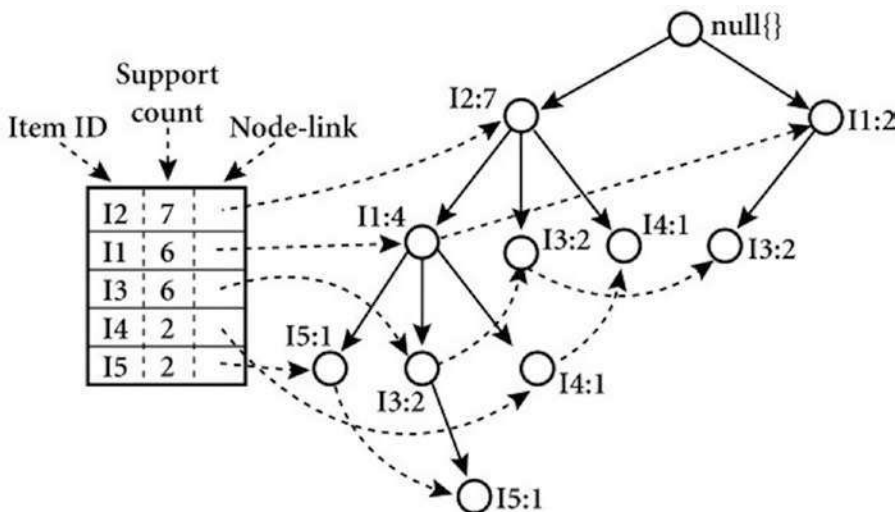

**Figure 8-10.** An example of an FP-tree

We will not go into detailed mathematical descriptions of the algorithm here, as the intent is to not to keep this section math heavy but to focus on how it can be leveraged to find patterns in this data. However, we will explain it in brief so you can understand the core concepts in this method. The FP growth algorithm uses a divide-and-conquer strategy and leverages a special data structure called the FP-tree, as depicted in Figure 8-10, to find frequent itemsets without generating all itemsets. The core steps of the algorithm are as follows:

1. Take in the transactional database and create an FP-tree structure to represent frequent itemsets.
2. Divide this compressed representation into multiple conditional datasets such that each one is associated with a frequent pattern.
3. Mine for patterns in each such dataset so that shorter patterns can be recursively concatenated to longer patterns, hence making it more efficient.

If you are interested in finding about it, you can refer to the Wikibooks link at [https://en.wikibooks.org/wiki/Data\\_Mining\\_Algorithms\\_In\\_R/Frequent\\_Pattern\\_Mining/The\\_FP-Growth\\_Algorithm](https://en.wikibooks.org/wiki/Data_Mining_Algorithms_In_R/Frequent_Pattern_Mining/The_FP-Growth_Algorithm), which talks about FP growth and the FP tree structure in detail.

## Association Rule-Mining in Action

We will illustrate association rule-mining using the famous grocery dataset. The dataset is available by default in the R language’s base package. To use in Python, you can obtain it from <https://github.com/stedy/Machine-Learning-with-R-datasets/blob/master/groceries.csv> or even from our official GitHub repository mentioned at the start of this chapter. This dataset consists of a collection of transactions that are sourced from a grocery retailer. We will use this data as the basis of our analysis and build our rule-mining work flow using this data.

Once we have grasped the basics of association rule-mining on the grocery dataset, we will leave it as an exercise for you to apply the same concepts on our transaction dataset that we used in the customer segmentation section. Remember to load the following dependencies before getting started.

```
import csv
import pandas as pd
import matplotlib.pyplot as plt
import Orange
from Orange.data import Domain, DiscreteVariable, ContinuousVariable
from orangecontrib.associate.fpgrowth import *

%matplotlib inline
```

Check out the “Mining Rules” section for details on how to install the Orange framework dependencies. The code for this section is available in the Cross Selling.ipynb notebook.

## Exploratory Data Analysis

The grocery dataset that we mentioned earlier is arranged so that each of the line occurring in the dataset is a transaction. The items given in each row are comma-separated and are the items in that particular transaction. Take a look at the first few lines of the dataset depicted in Figure 8-11.

```

1 citrus fruit,semi-finished bread,margarine,ready soups
2 tropical fruit,yogurt,coffee
3 whole milk
4 pip fruit,yogurt,cream cheese ,meat spreads
5 other vegetables,whole milk,condensed milk,long life bakery product
6 whole milk,butter,yogurt,rice,abrasive cleaner
7 rolls/buns
8 other vegetables,UHT-milk,rolls/buns,bottled beer,liquor (appetizer)
9 pot plants
10 whole milk,cereals
11 tropical fruit,other vegetables,white bread,bottled water,chocolate
12 citrus fruit,tropical fruit,whole milk,butter,curd,yogurt,flour,bottled water,dishes

```

**Figure 8-11.** Grocery dataset transactions

The first observation that we make from this dataset is that it is not available in a completely structured, easy-to-analyze format. This limitation will mean that the first thing we will have to do is to write custom code that will convert the raw file into a data structure we can use. Since we have done most of our analysis until now using the pandas dataframe, we will convert this data into a similar data structure. The following code snippet will perform the conversion for us.

```

grocery_items = set()
with open("grocery_dataset.txt") as f:
    reader = csv.reader(f, delimiter=",")
    for i, line in enumerate(reader):
        grocery_items.update(line)
output_list = list()
with open("grocery_dataset.txt") as f:
    reader = csv.reader(f, delimiter=",")
    for i, line in enumerate(reader):
        row_val = {item:0 for item in grocery_items}
        row_val.update({item:1 for item in line})
        output_list.append(row_val)

```

```
grocery_df = pd.DataFrame(output_list)
```

```
In [3]: grocery_df.shape
Out[3]: (9835, 169)
```

The conversion gives us a dataframe of dimension (num\_transaction, total\_items), where each transaction row has columns corresponding to its constituent items as 1. For example, for row 3 in Figure 8-11, we will have the column for whole milk as 1 and the rest of columns will be all 0. Although this data structure is sparse, meaning it has a lot of zeros, our framework that extracts association rules will take care of this sparseness.

Before we proceed to building association rules on our dataset, we will explore some salient features of our dataset. We already know that we have 9,835 total transactions and a total of 169 items in the dataset. But what are the top 10 items that occur in the dataset and how much of the total sales they account for. We can plot a simple histogram that will help us extract this information.

```

In [4]: total_item_count = sum(grocery_df.sum())
...: print(total_item_count)
...: item_summary_df = grocery_df.sum().sort_values(ascending = False).reset
...: _index().head(n=20)
...: item_summary_df.rename(columns={item_summary_df.columns[0]:'item_name',

```

```

...: item_summary_df.columns[1]='item_count', inplace=True)
...: item_summary_df.head()
43367
Out[4]:
   item_name  item_count
0  whole milk      2513
1  other vegetables  1903
2    rolls/buns    1809
3         soda    1715
4        yogurt    1372

```

For creating the histogram, we will create a summary dataframe using the previous code. This tells us that we have a total of 43,000+ items occurring in total in all those transactions and we also see the top five most sold items. Let's use this dataframe to plot the top 20 most sold items. The following snippet of code will help us create the required bar graph.

```

objects = (list(item_summary_df['item_name'].head(n=20)))
y_pos = np.arange(len(objects))
performance = list(item_summary_df['item_count'].head(n=20))
plt.bar(y_pos, performance, align='center', alpha=0.5)
plt.xticks(y_pos, objects, rotation='vertical')
plt.ylabel('Item count')
plt.title('Item sales distribution')

```

The bar graph depicting the item sales is depicted in Figure 8-12. It indicates that a surprisingly large share of total items is claimed by only these 20 items.

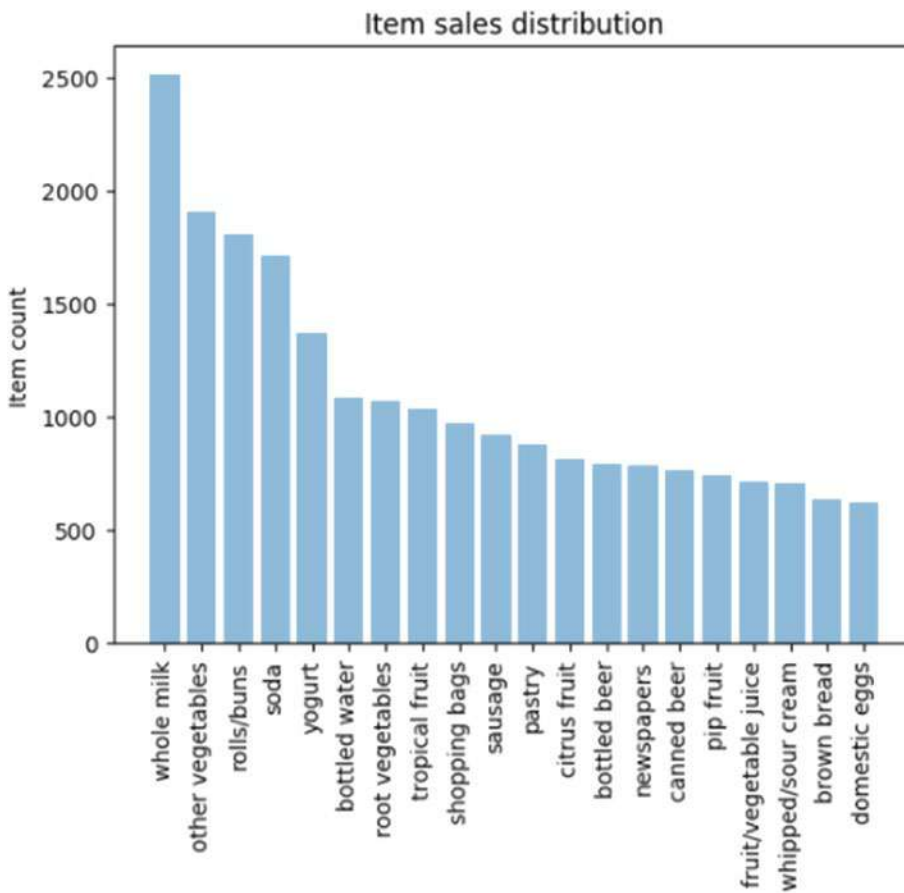

**Figure 8-12.** Grocery dataset top 20 items based on sales

Let's also find out how much percentage of total sales is explained by these 20 items alone. We will use the cumulative sum function offered by pandas (`cumsum`) to find this out. We will create two columns in our dataframe. One will tell how much percentage of total sales can be attributed to a particular item and the other will keep a cumulative sum of this sales percentage.

```
item_summary_df['item_perc'] = item_summary_df['item_count']/total_item_count
item_summary_df['total_perc'] = item_summary_df.item_perc.cumsum()
item_summary_df.head(10)
```

	item_name	item_count	item_perc	total_perc
0	whole milk	2513	0.057947	0.057947
1	other vegetables	1903	0.043881	0.101829
2	rolls/buns	1809	0.041714	0.143542
3	soda	1715	0.039546	0.183089
4	yogurt	1372	0.031637	0.214725

```
In [12]: item_summary_df[item_summary_df.total_perc <= 0.5].shape
Out[12]: (19, 4)
```



This shows us that the top five items are responsible for 21.4% of the entire sales and only the top 20 items are responsible for over 50% of the sales! This is important for us, as we don't want to find association rules for items which are bought very infrequently. With this information we can limit the items we want to explore for creating our association rules. This also helps us in keeping our possible itemset number to a manageable figure.

## Mining Rules

We will be using the Orange and the Orange3-Associate frameworks, which can be installed using the commands `conda install orange3` and `pip install orange3-associate`. The orange3-associate package contains the implementation of FP growth provided by the group who developed for the Orange data mining package, The Bioinformatics Laboratory at the University of Ljubljana, Slovenia (<https://fri.uni-lj.si/en/laboratory/biolab>).

---

■ **Note** We encourage you to experiment with the Orange package, which is available at <https://orange.biolab.si/>. It is a GUI-driven data mining framework written in Python and highly conducive for learning data analysis in an interactive way.

---

Before we go on using the package for finding association rules, we will discuss about the way data is represented in Orange library. The data representation is a little tricky but we will help you modify the existing data into the format required by Orange. Primarily we will focus on how to convert our pandas dataframes to the Orange Table data structure.

## Orange Table Data Structure

The Table data structure is the primary way to represent any tabular data in Orange. Although it is similar in some way to a numpy array or a pandas dataframe, it differs from them in the way it stores metadata about the actual data. In our case we can easily convert our pandas dataframe to the Table data structure by providing the metadata about our columns. We need to define the domain for each of our variables. The domain means the possible set of values that each of our variables can use. This information will be stored as metadata and will be used in later transformation of the data. As our columns are only having binary values—i.e. either 0 or 1—we can easily create the domain by using this information. The following code snippet helps us convert our dataframe to an Orange table.

```
from Orange.data import Domain, DiscreteVariable, ContinuousVariable
from orangecontrib.associate.fpgrowth import *

input_assoc_rules = grocery_df
domain_grocery = Domain([DiscreteVariable.make(name=item, values=['0', '1']) for item in
                        input_assoc_rules.columns])
data_gro_1 = Orange.data.Table.from_numpy(domain=domain_grocery,
                                         X=input_assoc_rules.as_matrix(),Y= None)
```

Here we defined the domain of our data by specifying each variable as a DiscreteVariable having values as (0, 1). Then using this domain, we created our Table structure for our data.

## Using the FP Growth Algorithm

Now we have all the pieces required to perform our rule-mining. But before proceeding, we want to take care of one more important aspect of the analysis. We saw in the earlier section how only a handful of items are responsible for bulk of our sales so we want to prune our dataset to reflect this information. For this we have created a function `prune_dataset` (check out the notebook), which will help us reduce the size of our dataset based on our requirements. The function can be used for performing two types of pruning:

- **Pruning based on percentage of total sales:** The parameter `total_sales_perc` will help us select the number of items that will explain the required percentage of sales. The default value is 50% or 0.5.
- **Pruning based on ranks of items:** Another way to perform the pruning is to specify the starting and the ending rank of the items for which we want to prune our dataset.

By default, we will only look for transactions which have at least two items, as transactions with only one item are counter to the whole concept of association rule-mining. The following code snippet will help us select only that subset of data which explain **40%** of the total sales by leveraging our pruning function.

```
output_df, item_counts = prune_dataset(input_df=grocery_df, length_trans=2, total_sales_perc=0.4)
print(output_df.shape)
print(list(output_df.columns))

(4585, 13)
['whole milk', 'other vegetables', 'rolls/buns', 'soda', 'yogurt', 'bottled water', 'root
vegetables', 'tropical fruit', 'shopping bags', 'sausage', 'pastry', 'citrus fruit',
'bottled beer']
```

So we find out that we have only 13 items responsible for 40% of sales and 4585 transactions that have those items along with other items and we can also see what those items are. The next step is to convert this selected data into the required Table data structure.

```
input_assoc_rules = output_df
domain_grocery = Domain([DiscreteVariable.make(name=item, values=['0', '1']) for item in
                        input_assoc_rules.columns])
data_gro_1 = Orange.data.Table.from_numpy(domain=domain_grocery,
                                         X=input_assoc_rules.as_matrix(), Y=None)
data_gro_1_en, mapping = OneHot.encode(data_gro_1, include_class=False)
```

The new addition to the previous code is the last line. This is required for coding our input so that the entire domain is represented as binary variables. This will complete all the parsing and data manipulation required for our rule-mining. Phew!

The final step is creating our rules. We need to specify two pieces of information for generating our rules: support and confidence. We have already defined both of them conceptually earlier, so we will not be defining them again. An important piece of information is to start with a higher support, as lower support will mean a higher number of frequent itemsets and hence a longer execution time. We will specify a min-support of **0.01—45** transactions at least—and see the number of frequent itemsets that we get before we specify confidence and generate our rules.

```
min_support = 0.01
print("num of required transactions = ", int(input_assoc_rules.shape[0]*min_support))
num_trans = input_assoc_rules.shape[0]*min_support
itemsets = dict(frequent_itemsets(data_gro_1_en, min_support=min_support))
```

```
num of required transactions = 45
```

```
In [25]: len(itemsets)
Out[25]: 166886
```

So we get a whopping 166,886 itemsets for a support of only 1%! This will increase exponentially if we decrease the support or if we increase the number of items in our dataset. The next step is specifying a confidence value and generating our rules. We have written a code snippet that will take a confidence value and generate the rules that fulfill our specified support and confidence criteria. The rules generated are then decoded using the mapping and variable names. Orange3-Associate also provides a helper function that will help us extract metrics about each of these rules. The following code snippet will perform rule generation and decoding of rules, and then compile it all in a neat dataframe that we can use for further analysis.

```
confidence = 0.3
rules_df = pd.DataFrame()

if len(itemsets) < 1000000:
    rules = [(P, Q, supp, conf)
             for P, Q, supp, conf in association_rules(itemsets, confidence)
             if len(Q) == 1 ]

    names = {item: '{}={}'.format(var.name, val)
             for item, var, val in OneHot.decode(mapping, data_gro_1, mapping)}
    eligible_ante = [v for k,v in names.items() if v.endswith("1")]
    N = input_assoc_rules.shape[0] * 0.5
    rule_stats = list(rules_stats(rules, itemsets, N))
    rule_list_df = []
    for ex_rule_frm_rule_stat in rule_stats:
        ante = ex_rule_frm_rule_stat[0]
        cons = ex_rule_frm_rule_stat[1]
        named_cons = names[next(iter(cons))]
        if named_cons in eligible_ante:
            rule_lhs = [names[i][:-2] for i in ante if names[i] in eligible_ante]
            ante_rule = ', '.join(rule_lhs)
            if ante_rule and len(rule_lhs)>1 :
                rule_dict = {'support' : ex_rule_frm_rule_stat[2],
                             'confidence' : ex_rule_frm_rule_stat[3],
                             'coverage' : ex_rule_frm_rule_stat[4],
                             'strength' : ex_rule_frm_rule_stat[5],
                             'lift' : ex_rule_frm_rule_stat[6],
                             'leverage' : ex_rule_frm_rule_stat[7],
                             'antecedent': ante_rule,
                             'consequent':named_cons[:-2] }
                rule_list_df.append(rule_dict)
    rules_df = pd.DataFrame(rule_list_df)
    print("Raw rules data frame of {} rules generated".format(rules_df.shape[0]))
    if not rules_df.empty:
        pruned_rules_df = rules_df.groupby(['antecedent', 'consequent']).max().reset_index()
    else:
        print("Unable to generate any rule")
```

```
Raw rules data frame of 16628 rules generated
```

The output of this code snippet consists of the association rules dataframe that we can use for our analysis. You can play around with the item number, consequent, antecedent, support, and confidence values to generate different rules. Let's take some sample rules generated using transactions that explain 40% of total sales, min-support of 1% (required number of transactions  $\geq 45$ ) and confidence greater than 30%. Here, we have collected rules having maximum lift for each of the items that can be a consequent (that appear on the right side) by using the following code.

```
(pruned_rules_df[['antecedent', 'consequent',
                  'support', 'confidence', 'lift']].groupby('consequent')
          .max()
          .reset_index()
          .sort_values(['lift',
                       'support', 'confidence'],
                       ascending=False))
```

	consequent	antecedent	support	confidence	lift
4	root vegetables	yogurt, whole milk, tropical fruit	228	0.463636	2.230611
5	sausage	shopping bags, rolls/buns	59	0.393162	2.201037
8	tropical fruit	yogurt, root vegetables, whole milk	92	0.429907	2.156588
1	citrus fruit	whole milk, other vegetables, tropical fruit	66	0.333333	2.125637
10	yogurt	whole milk, tropical fruit	199	0.484211	1.891061
2	other vegetables	yogurt, whole milk, tropical fruit	228	0.643836	1.826724
6	shopping bags	sausage, soda	50	0.304878	1.782992
0	bottled water	yogurt, soda	59	0.333333	1.707635
9	whole milk	yogurt, tropical fruit	228	0.754098	1.703222
3	rolls/buns	yogurt, whole milk, tropical fruit	97	0.522222	1.679095
7	soda	yogurt, sausage	95	0.390625	1.398139

**Figure 8-13.** Association rules on the grocery dataset

Let's interpret the first rule, which states that:

$$\{\text{yogurt, whole milk, tropical fruit} \rightarrow \text{root vegetables}\}$$

The pattern that the rule states in the equation is easy to understand—people who bought yogurt, whole milk, and tropical fruit also tend to buy root vegetables. Let's try to understand the metrics. Support of the rule is **228**, which means, all the items together appear in **228** transactions in the dataset. Confidence of the rule is **46%**, which means that **46%** of the time the antecedent items occurred we also had the consequent in the transaction (i.e. 46% of times, customers who bought the left side items also bought root vegetables). Another important metric in Figure 8-13 is Lift. *Lift* means that the probability of finding root vegetables in the transactions which have yogurt, whole milk, and tropical fruit is greater than the normal probability

of finding root vegetables in the previous transactions (**2.23**). Typically, a lift value of 1 indicates that the probability of occurrence of the antecedent and consequent together are independent of each other. Hence, the idea is to look for rules having a lift much greater than 1. In our case, all the previously mentioned rules are good quality rules.

This is a significant piece of information, as this can prompt a retailer to bundle specific products like these together or run a marketing scheme that offers discount on buying root vegetables along with these other three products.

We encourage you to try similar analyses with your own datasets in the future and also with the online retail transactions dataset that we used for our market segmentation case study. Considering the dataset Online Retail from market segmentation, the workflow for that particular analysis will be very similar. The only difference among these two datasets is the way in which they are represented. You can leverage the following code snippets to analyze patterns from the United Kingdom in that dataset.

```
cs_mba = pd.read_excel(io=r'Online Retail.xlsx')
cs_mba_uk = cs_mba[cs_mba.Country == 'United Kingdom']
# remove returned items
cs_mba_uk = cs_mba_uk[~(cs_mba_uk.InvoiceNo.str.contains("C") == True)]
cs_mba_uk = cs_mba_uk[~cs_mba_uk.Quantity<0]

# create transactional database
items = list(cs_mba_uk.Description.unique())
grouped = cs_mba_uk.groupby('InvoiceNo')
transaction_level_df_uk = grouped.aggregate(lambda x: tuple(x)).reset_index()
[['InvoiceNo', 'Description']]
transaction_dict = {item:0 for item in items}
output_dict = dict()
temp = dict()
for rec in transaction_level_df_uk.to_dict('records'):
    invoice_num = rec['InvoiceNo']
    items_list = rec['Description']
    transaction_dict = {item:0 for item in items}
    transaction_dict.update({item:1 for item in items if item in items_list})
    temp.update({invoice_num:transaction_dict})

new = [v for k,v in temp.items()]
transaction_df = pd.DataFrame(new)
del(transaction_df[transaction_df.columns[0]])
```

Once you build the transactional dataset, you can choose your own configuration based on which you want to extract and mine rules. For instance, the following code mines for patterns on the top **15** most sold products with min-support of **0.01** (min transactions **49**) and minimum confidence of **0.3**

```
output_df_uk_n, item_counts_n = prune_dataset(input_df=transaction_df, length_trans=2,
                                              start_item=0, end_item=15)

input_assoc_rules = output_df_uk_n
domain_transac = Domain([DiscreteVariable.make(name=item, values=['0', '1']) for item in
                        input_assoc_rules.
                        columns])

data_tran_uk = Orange.data.Table.from_numpy(domain=domain_transac, X=input_assoc_rules.
as_matrix(), Y= None)
data_tran_uk_en, mapping = OneHot.encode(data_tran_uk, include_class=True)
```

```

support = 0.01
num_trans = input_assoc_rules.shape[0]*support
itemsets = dict(frequent_itemsets(data_tran_uk_en, support))
confidence = 0.3
rules_df = pd.DataFrame()
... # rest of the code similar to what we did earlier

```

The rest of the analysis can be performed using the same workflow which we used for the groceries dataset. Feel free to check out the `Cross Selling.ipynb` notebook in case you get stuck. Figure 8-14 shows some patterns from the previous analysis on our Online Retail dataset.

	consequent	antecedent	support	confidence	lift
8	PACK OF 72 RETROSPOT CAKE CASES	WHITE HANGING HEART T-LIGHT HOLDER, REGENCY CAKESTAND 3 TIER, NATURAL SLATE HEART CHALKBOARD	145	0.971014	5.394404
9	PAPER CHAIN KIT 50'S CHRISTMAS	WHITE HANGING HEART T-LIGHT HOLDER, REGENCY CAKESTAND 3 TIER, NATURAL SLATE HEART CHALKBOARD	94	0.597701	4.341428
3	JUMBO SHOPPER VINTAGE RED PAISLEY	WHITE HANGING HEART T-LIGHT HOLDER, PAPER CHAIN KIT 50'S CHRISTMAS	384	0.879310	4.218819
5	LUNCH BAG BLACK SKULL.	WHITE HANGING HEART T-LIGHT HOLDER, PACK OF 72 RETROSPOT CAKE CASES, LUNCH BAG RED RETROSPOT	227	0.852459	4.078157
4	JUMBO STORAGE BAG SUKI	WHITE HANGING HEART T-LIGHT HOLDER, SET OF 3 CAKE TINS PANTRY DESIGN , JUMBO BAG PINK POLKADOT	405	0.852459	4.016191

**Figure 8-14.** Association rules on the online retail dataset for UK customers

It is quite evident from the metrics in Figure 8-14 that these are excellent quality rules. We can see that items relevant to baking are purchased together and items like bags are purchased together. Try changing the previously mentioned parameters and see if you can find more interesting patterns!

## Summary

In this chapter, we read about some simple yet high-value case studies. The crux of the chapter was to realize that the most important part about any analytics or Machine Learning-based solution is the value it can deliver to the organization. Being an analytics or data science professional, we must always try to balance the value aspect of our work with its technical complexity. We learned some important methods that have the potential to directly contribute to the revenue generation of organizations and retail establishments. We looked at ideas pertaining to customer segmentation, its impact, and explored a novel way of using unsupervised learning to find out customer segments and view interesting patterns and behavior. Cross selling introduced us to the world of pattern-mining and rule-based frameworks like association rule-mining and principles like market basket analysis. We utilized a framework that was entirely different from the ones that we have used until now and understood the value of data parsing and pre-processing besides regular modeling and analysis. In subsequent chapters of this book, we increase the technical complexity of our case studies, but we urge you to always have an eye out for defining the value and impact of these solutions. Stay tuned!

## CHAPTER 9



# Analyzing Wine Types and Quality

In the last chapter, we looked at specific case studies leveraging unsupervised Machine Learning techniques like clustering and rule-mining frameworks. In this chapter, we focus on some more case studies relevant to supervised Machine Learning algorithms and predictive analytics. We have looked at classification based problems in Chapter 7, where we built sentiment classifiers based on text reviews to predict the sentiment of movie reviews. In this chapter, the problem at hand is to analyze, model, and predict the type and quality of wine using physicochemical attributes. Wine is a pleasant tasting alcoholic beverage, loved by millions across the globe. Indeed many of us love to celebrate our achievements or even unwind at the end of a tough day with a glass of wine! The following quote from Francis Bacon should whet your appetite about wine and its significance.

*“Age appears best in four things: old wood to burn, old wine to drink, old friends to trust, and old authors to read.”*

—Francis Bacon

Regardless of whether you like and consume wine or not, it will definitely be interesting to analyze the physicochemical attributes of wine and understand their relationships and significance with wine quality and types. Since we will be trying to predict wine types and quality, the supervised Machine Learning task involved here is classification. In this chapter, we look at various ways to analyze and visualize wine data attributes and features. We focus on univariate as well as multivariate analyses. For predicting wine types and quality, we will be building classifiers based on state-of-the-art supervised Machine Learning techniques, including logistic regression, deep neural networks, decision trees, and ensemble models like random forests and gradient boosting to name a few. Special emphasis is on analyzing, visualizing, and modeling data such that you can emulate similar principles on your own classification based real-world problems in the future. We would like to thank the UC Irvine ML repository for the dataset. Also a special mention goes to DataCamp and Karlijn Willems, notable Data Science journalist, who has done some excellent work in analyzing the wine quality dataset and has written an article on her findings at <https://www.datacamp.com/community/tutorials/deep-learning-python>, which you can check out for more details. We have taken a couple of analyses and explanations from this article as an inspiration for our chapter and Karlijn has been more than helpful in sharing the same with us.

## Problem Statement

“Given a dataset, or in this case two datasets that deal with physicochemical properties of wine, can you guess the wine type and quality?” This is the main objective of this chapter. Of course this doesn’t mean the entire focus will be only on leveraging Machine Learning to build predictive models. We will process, analyze, visualize, and model our dataset based on standard Machine Learning and data mining workflow models like the CRISP-DM model.

The datasets used in this chapter are available in the very popular UCI Machine Learning Repository under the name of *Wine Quality Data Set*. You can access more details at <https://archive.ics.uci.edu/ml/datasets/wine+quality>, which gives you access to the raw datasets as well as details about the various features in the datasets. There are two datasets, one for red wines and the other for white wines. To be more specific, the wine datasets are related to red and white vinho verde wine samples, from the north of Portugal. Another file in the same web page talks about the details for the datasets including attribute information. Credits for the datasets go out to P. Cortez, A. Cerdeira, F. Almeida, T. Matos, and J. Reis and you can get more details in their paper, “Modeling wine preferences by data mining from physicochemical properties” in *Decision Support Systems*, Elsevier, 47(4): 547-553, 2009.

To summarize our main objectives, we will be trying to solve the following major problems by leveraging Machine Learning and data analysis on our wine quality dataset.

- Predict if each wine sample is a red or white wine.
- Predict the quality of each wine sample, which can be low, medium, or high.

Let’s get started by setting up the necessary dependencies before moving on to accessing and analyzing our data!

## Setting Up Dependencies

We will be using several Python libraries and frameworks specific to Machine Learning and Deep Learning. Just like in our previous chapters, you need to make sure you have `pandas`, `numpy`, `scipy`, and `scikit-learn` installed, which will be used for data processing and Machine Learning. We will also use `matplotlib` and `seaborn` extensively for exploratory data analysis and visualizations. Deep Learning frameworks used in this chapter include `keras` with the `tensorflow` backend, but you can also use `theano` as the backend if you choose to do so. We also use the `xgboost` library for the gradient boosting ensemble model. Utilities related to supervised model fitting, prediction, and evaluation are present in `model_evaluation_utils.py`, so make sure you have these modules in the same directory and the other Python files and jupyter notebooks for this chapter, which you can obtain from the relevant directory for this chapter on GitHub at <https://github.com/dipanjanS/practical-machine-learning-with-python>.

## Getting the Data

The datasets will be available along with the code files for this chapter in the GitHub repository for this book at <https://github.com/dipanjanS/practical-machine-learning-with-python> under the respective folder for Chapter 9. The following files refer to the datasets of interest.

- The file named `winequality-red.csv` contains the dataset pertaining to 1599 records of red wine samples
- The file named `winequality-white.csv` contains the dataset pertaining to 4898 records of white wine samples
- The file named `winequality.names` consists of detailed information and the data dictionary pertaining to the datasets

You can also download the same data from <https://archive.ics.uci.edu/ml/datasets/wine+quality> if needed. Once you have the CSV file, you can easily load it in Python using the `read_csv(...)` utility function from `pandas`.



## Exploratory Data Analysis

Standard Machine Learning and analytics workflow recommend processing, cleaning, analyzing, and visualizing your data before moving on toward modeling your data. We will also follow the same workflow we used in all our other chapters. You can refer to the Python file titled `exploratory_data_analysis.py` for all the code used in this section or use the jupyter notebook titled `Exploratory Data Analysis.ipynb` for a more interactive experience.

### Process and Merge Datasets

Let's load the following necessary dependencies and configuration settings.

```
import pandas as pd
import matplotlib.pyplot as plt
import matplotlib as mpl
import numpy as np
import seaborn as sns
```

```
%matplotlib inline
```

We will now process the datasets (red and white wine) and add some additional variables that we would want to predict in future sections. The first variable we will add is `wine_type`, which would be either red or white wine based on the dataset and the wine sample. The second variable we will add is `quality_label`, which is a qualitative measure of the quality of the wine sample based on the `quality` variable score. The rules used for mapping `quality` to `quality_label` are described as follows.

- Wine quality scores of 3, 4, and 5 are mapped to low quality wines under the `quality_label` attribute.
- Wine quality scores of 6 and 7 are mapped to medium quality wines under the `quality_label` attribute.
- Wine quality scores of 8 and 9 are mapped to high quality wines under the `quality_label` attribute.

After adding these attributes, we also merge the two datasets for red and white wine together to create a single dataset and we use `pandas` to merge and shuffle the records of the data frame. The following snippet helps us in achieving this.

```
In [3]: white_wine = pd.read_csv('winequality-white.csv', sep=';')
...: red_wine = pd.read_csv('winequality-red.csv', sep=';')
...:
...: # store wine type as an attribute
...: red_wine['wine_type'] = 'red'
...: white_wine['wine_type'] = 'white'
...: # bucket wine quality scores into qualitative quality labels
...: red_wine['quality_label'] = red_wine['quality'].apply(lambda value: 'low'
...:                                                     if value <= 5 else 'medium'
...:                                                     if value <= 7 else 'high')
...: red_wine['quality_label'] = pd.Categorical(red_wine['quality_label'],
...:                                           categories=['low', 'medium', 'high'])
...: white_wine['quality_label'] = white_wine['quality'].apply(lambda value: 'low'
```

```

...:                                     if value <= 5 else 'medium'
...:                                     if value <= 7 else 'high')
...: white_wine['quality_label'] = pd.Categorical(white_wine['quality_label'],
...:                                     categories=['low', 'medium', 'high'])
...:
...: # merge red and white wine datasets
...: wines = pd.concat([red_wine, white_wine])
...: # re-shuffle records just to randomize data points
...: wines = wines.sample(frac=1, random_state=42).reset_index(drop=True)

```

Our objective in future sections would be to predict `wine_type` and `quality_label` based on other features in the `wines` dataset. Let's now try to understand more about our dataset and its features.

## Understanding Dataset Features

The `wines` dataframe we obtained in the previous section is our final dataset we will be using for our analysis and modeling. We will also be using the `red_wine` and `white_wine` dataframes where necessary for basic exploratory analysis and visualizations. Let's start by looking at the total number of data samples we are dealing with and also the different features in our dataset.

```

In [3]: print(white_wine.shape, red_wine.shape)
...: print(wines.info())
(4898, 14) (1599, 14)
<class 'pandas.core.frame.DataFrame'>
RangeIndex: 6497 entries, 0 to 6496
Data columns (total 14 columns):
fixed acidity          6497 non-null float64
volatile acidity      6497 non-null float64
citric acid           6497 non-null float64
residual sugar        6497 non-null float64
chlorides              6497 non-null float64
free sulfur dioxide   6497 non-null float64
total sulfur dioxide  6497 non-null float64
density               6497 non-null float64
pH                    6497 non-null float64
sulphates             6497 non-null float64
alcohol               6497 non-null float64
quality               6497 non-null int64
wine_type             6497 non-null object
quality_label         6497 non-null category
dtypes: category(1), float64(11), int64(1), object(1)
memory usage: 666.4+ KB

```

This information tells us that we have 4898 white wine data points and 1599 red wine data points. The merged dataset contains a total of 6497 data points and we also get an idea of numeric and categorical attributes. Let's take a peek at our dataset to see some sample data points.

```

In [4]: wines.head()

```

Out[4]:

	fixed acidity	volatile acidity	citric acid	residual sugar	chlorides	free sulfur dioxide	total sulfur dioxide	density	pH	suiphates	alcohol	quality	wine_type	quality_label
0	7.0	0.17	0.74	12.8	0.045	24.0	126.0	0.99420	3.26	0.38	12.2	8	white	high
1	7.7	0.64	0.21	2.2	0.077	32.0	133.0	0.99560	3.27	0.45	9.9	5	red	low
2	6.8	0.39	0.34	7.4	0.020	38.0	133.0	0.99212	3.18	0.44	12.0	7	white	medium
3	6.3	0.28	0.47	11.2	0.040	61.0	183.0	0.99592	3.12	0.51	9.5	6	white	medium
4	7.4	0.35	0.20	13.9	0.054	63.0	229.0	0.99888	3.11	0.50	8.9	6	white	medium

Figure 9-1. Sample data points from the wine quality dataset

The output depicted in Figure 9-1 shows us sample wine records for our wine quality dataset. Looking at the values, we can get an idea of numeric as well as categorical features. Let's now try to gain some domain knowledge about wine and its attributes. Domain knowledge is essential and always recommended, especially if you are trying to analyze and model data from diverse domains.

Wine is an alcoholic beverage made by the process of fermentation of grapes, without the addition of sugars, acids, enzymes, water, or other nutrients. Red and white wine are two variants. Usually, red wine is made from dark red and black grapes. The color ranges from various shades of red, brown, and violet. This is produced with whole grapes, including the skin, which adds to the color and flavor of red wines giving it a rich flavor. White wine is made from white grapes with no skins or seeds. The color is usually straw-yellow, yellow-green, or yellow-gold. Most white wines have a light and fruity flavor as compared to richer red wines. Let's now dive into details for each feature in the dataset. Credits once again go to Karlijn for some of the attribute descriptions. Our dataset has a total of 14 attributes and they are described as follows.

- fixed acidity:** Acids are one of the fundamental properties of wine and contribute greatly to the taste of the wine. Reducing acids significantly might lead to wines tasting flat. Fixed acids include tartaric, malic, citric, and succinic acids, which are found in grapes (except succinic). This variable is usually expressed in  $\frac{g(\text{tartaricacid})}{dm^3}$  in the dataset.
- volatile acidity:** These acids are to be distilled out from the wine before completing the production process. It is primarily constituted of acetic acid, though other acids like lactic, formic, and butyric acids might also be present. Excess of volatile acids are undesirable and lead to unpleasant flavor. In the United States, the legal limits of volatile acidity are 1.2 g/L for red table wine and 1.1 g/L for white table wine. The volatile acidity is expressed in  $\frac{g(\text{aceticacid})}{dm^3}$  in the dataset.
- citric acid:** This is one of the fixed acids that gives a wine its freshness. Usually most of it is consumed during the fermentation process and sometimes it is added separately to give the wine more freshness. It's usually expressed in  $\frac{g}{dm^3}$  in the dataset.
- residual sugar:** This typically refers to the natural sugar from grapes that remains after the fermentation process stops, or is stopped. It's usually expressed in  $\frac{g}{dm^3}$  in the dataset.

- **chlorides:** This is usually a major contributor to saltiness in wine. It's usually expressed in  $\frac{g(\text{sodiumchloride})}{dm^3}$  in the dataset.
- **free sulfur dioxide:** This is the part of the sulfur dioxide that, when added to a wine, is said to be free after the remaining part binds. Winemakers will always try to get the highest proportion of free sulfur to bind. They are also known as sulfites and too much is undesirable and gives a pungent odor. This variable is expressed in  $\frac{mg}{dm^3}$  in the dataset.
- **total sulfur dioxide:** This is the sum total of the bound and the free sulfur dioxide ( $SO_2$ ). Here, it's expressed in  $\frac{mg}{dm^3}$ . This is mainly added to kill harmful bacteria and preserve quality and freshness. There are usually legal limits for sulfur levels in wines and excess of it can even kill good yeast and produce an undesirable odor.
- **density:** This can be represented as a comparison of the weight of a specific volume of wine to an equivalent volume of water. It is generally used as a measure of the conversion of sugar to alcohol. Here, it's expressed in  $\frac{g}{cm^3}$ .
- **pH:** Also known as the potential of hydrogen, this is a numeric scale to specify the acidity or basicity the wine. Fixed acidity contributes the most toward the pH of wines. You might know, solutions with a pH less than 7 are acidic, while solutions with a pH greater than 7 are basic. With a pH of 7, pure water is neutral. Most wines have a pH between 2.9 and 3.9 and are therefore acidic.
- **sulphates:** These are mineral salts containing sulfur. Sulphates are to wine as gluten is to food. They are a regular part of the winemaking around the world and are considered essential. They are connected to the fermentation process and affect the wine aroma and flavor. Here, they are expressed in  $\frac{g(\text{potassiumsulphate})}{dm^3}$  in the dataset.
- **alcohol:** Wine is an alcoholic beverage. Alcohol is formed as a result of yeast converting sugar during the fermentation process. The percentage of alcohol can vary from wine to wine. Hence it is not a surprise for this attribute to be a part of this dataset. It's usually measured in % vol or alcohol by volume (ABV).
- **quality:** Wine experts graded the wine quality between 0 (*very bad*) and 10 (*very excellent*). The eventual quality score is the median of at least three evaluations made by the same wine experts.
- **wine\_type:** Since we originally had two datasets for red and white wine, we introduced this attribute in the final merged dataset, which indicates the type of wine for each data point. A wine can be a red or a white wine. One of the predictive models we will build in this chapter would be such that we can predict the type of wine by looking at other wine attributes.

- **quality\_label:** This is a derived attribute from the quality attribute. We bucket or group wine quality scores into three qualitative buckets, namely low, medium, and high. Wines with a quality score of 3, 4, and 5 are *low quality*; scores of 6 and 7 are *medium quality*; and scores of 8 and 9 are *high quality* wines. We will also build another model in this chapter to predict this wine quality label based on other wine attributes.

Now that you have a solid foundation on the dataset as well as its features, let's analyze and visualize various features and their interactions.

## Descriptive Statistics

We will start by computing some descriptive statistics of our various features of interest in our dataset. This involves computing aggregation metrics like mean, median, standard deviation, and so on. If you remember one of our primary objectives is to build a model that can correctly predict if a wine is a red or white wine based on its attributes. Let's build a descriptive summary table on various wine attributes separated by wine type.

```
In [5]: subset_attributes = ['residual sugar', 'total sulfur dioxide', 'sulphates',
...:                        'alcohol', 'volatile acidity', 'quality']
...: rs = round(red_wine[subset_attributes].describe(),2)
...: ws = round(white_wine[subset_attributes].describe(),2)
...: pd.concat([rs, ws], axis=1, keys=['Red Wine Statistics', 'White Wine Statistics'])
```

Out[5]:

	Red Wine Statistics						White Wine Statistics					
	residual sugar	total sulfur dioxide	sulphates	alcohol	volatile acidity	quality	residual sugar	total sulfur dioxide	sulphates	alcohol	volatile acidity	quality
count	1599.00	1599.00	1599.00	1599.00	1599.00	1599.00	4898.00	4898.00	4898.00	4898.00	4898.00	4898.00
mean	2.54	46.47	0.66	10.42	0.53	5.64	6.39	138.36	0.49	10.51	0.28	5.88
std	1.41	32.90	0.17	1.07	0.18	0.81	5.07	42.50	0.11	1.23	0.10	0.89
min	0.90	6.00	0.33	8.40	0.12	3.00	0.60	9.00	0.22	8.00	0.08	3.00
25%	1.90	22.00	0.55	9.50	0.39	5.00	1.70	108.00	0.41	9.50	0.21	5.00
50%	2.20	38.00	0.62	10.20	0.52	6.00	5.20	134.00	0.47	10.40	0.26	6.00
75%	2.60	62.00	0.73	11.10	0.64	6.00	9.90	167.00	0.55	11.40	0.32	6.00
max	15.50	289.00	2.00	14.90	1.58	8.00	65.80	440.00	1.08	14.20	1.10	9.00

**Figure 9-2.** Descriptive statistics for wine attributes separated by wine type

The summary table depicted in Figure 9-2 shows us descriptive statistics for various wine attributes. Do you notice any interesting properties? For starters, mean residual sugar and total sulfur dioxide content in white wine seems to be much higher than red wine. Also, the mean value of sulphates and volatile acidity seem to be higher in red wine as compared to white wine. Try including other features too and see if you can find more interesting comparisons! Considering wine quality levels as data subsets, let's build some descriptive summary statistics with the following snippet.

```
In [6]: subset_attributes = ['alcohol', 'volatile acidity', 'pH', 'quality']
...: ls = round(wines[wines['quality_label'] == 'low'][subset_attributes].describe(),2)
...: ms = round(wines[wines['quality_label'] == 'medium'][subset_attributes].describe(),2)
...: hs = round(wines[wines['quality_label'] == 'high'][subset_attributes].describe(),2)
...: pd.concat([ls, ms, hs], axis=1, keys=['Low Quality Wine', 'Medium Quality Wine',
...:                                     'High Quality Wine'])
```

Out[6]:

	Low Quality Wine				Medium Quality Wine				High Quality Wine			
	alcohol	volatile acidity	pH	quality	alcohol	volatile acidity	pH	quality	alcohol	volatile acidity	pH	quality
<b>count</b>	2384.00	2384.00	2384.00	2384.00	3915.00	3915.00	3915.00	3915.00	198.00	198.00	198.00	198.00
<b>mean</b>	9.87	0.40	3.21	4.88	10.81	0.31	3.22	6.28	11.69	0.29	3.23	8.03
<b>std</b>	0.84	0.19	0.16	0.36	1.20	0.14	0.16	0.45	1.27	0.12	0.16	0.16
<b>min</b>	8.00	0.10	2.74	3.00	8.40	0.08	2.72	6.00	8.50	0.12	2.88	8.00
<b>25%</b>	9.30	0.26	3.11	5.00	9.80	0.21	3.11	6.00	11.00	0.21	3.13	8.00
<b>50%</b>	9.60	0.34	3.20	5.00	10.80	0.27	3.21	6.00	12.00	0.28	3.23	8.00
<b>75%</b>	10.40	0.50	3.31	5.00	11.70	0.36	3.33	7.00	12.60	0.35	3.33	8.00
<b>max</b>	14.90	1.58	3.90	5.00	14.20	1.04	4.01	7.00	14.00	0.85	3.72	9.00

Figure 9-3. Descriptive statistics for wine attributes separated by wine quality

The summary table depicted in Figure 9-3 shows us descriptive statistics for various wine attributes subset by wine quality ratings. Interestingly, mean alcohol levels seem to increase based on the rating of the wine quality. We also see that pH levels are almost consistent across the wine samples of varying quality. Is there any way to statistically prove this? We will see that in the following section.

## Inferential Statistics

The general notion of inferential statistics is to draw inferences and propositions of a population using a data sample. The idea is to use statistical methods and models to draw statistical inferences from a given hypotheses. Each hypothesis consists of a null hypothesis and an alternative hypothesis. Based on statistical test results, if the result is statistically significant based on pre-set significance levels (e.g., if obtained p-value is less than 5% significance level), we reject the null hypothesis in favor of the alternative hypothesis. Otherwise, if the results is not statistically significant, we conclude that our null hypothesis was correct. Coming back to our problem from the previous section, given multiple data groups or subsets of wine samples based on wine quality rating, is there any way to prove that mean alcohol levels or pH levels vary significantly among the data groups?

A great statistical model to prove or disprove the difference in mean among subsets of data is to use the one-way ANOVA test. ANOVA stands for “analysis of variance,” which is a nifty statistical model and can be used to analyze statistically significant differences among means or averages of various groups. This is basically achieved using a statistical test that helps us determine whether or not the means of several groups are equal. Usually the null hypothesis is represented as

$$H_0: \mu_1 = \mu_2 = \mu_3 = \dots = \mu_n$$

Where  $n$  is the number of data groups or subsets and it indicates that the group means for the various groups are not very different from each other based on statistical significance levels. The alternative hypotheses,  $H_A$ , tells us that there exists at least two group means that are statistically significantly different from each other. Usually the F-statistic and the associated p-value from it is used to determine the statistical significance. Typically a p-value less than 0.05 is taken to be a statistically significant result where we reject the null hypothesis in favor of the original. We recommend reading up a standard book on inferential statistics to gain more in-depth knowledge regarding these concepts.

For our scenario, three data subsets or groups from the data are created based on wine quality ratings. The mean values in the first test would be based on the wine alcohol content and the second test would be based on the wine pH levels. Also let's assume the null hypothesis is that the group means for low, medium, and high quality wine is same and the alternate hypothesis would be that there is a difference (statistically significant) between at least two group means. The following snippet helps us perform the one-way ANOVA test.

```
In [7]: from scipy import stats
...:
...: F, p = stats.f_oneway(wines[wines['quality_label'] == 'low']['alcohol'],
...:                      wines[wines['quality_label'] == 'medium']['alcohol'],
...:                      wines[wines['quality_label'] == 'high']['alcohol'])
...: print('ANOVA test for mean alcohol levels across wine samples with different quality
...:       ratings')
...: print('F Statistic:', F, '\ntp-value:', p)
...:
...: F, p = stats.f_oneway(wines[wines['quality_label'] == 'low']['pH'],
...:                      wines[wines['quality_label'] == 'medium']['pH'],
...:                      wines[wines['quality_label'] == 'high']['pH'])
...: print('\nANOVA test for mean pH levels across wine samples with different quality
...:       ratings')
...: print('F Statistic:', F, '\ntp-value:', p)
ANOVA test for mean alcohol levels across wine samples with different quality ratings
F Statistic: 673.074534723      p-value: 2.27153374506e-266

ANOVA test for mean pH levels across wine samples with different quality ratings
F Statistic: 1.23638608035      p-value: 0.290500277977
```

From the preceding results we can clearly see we have a p-value much less than 0.05 in the first test and greater than 0.05 in the second test. This tells us that there is a statistically significant difference in alcohol level means for at least two groups out of the three (rejecting the null hypothesis in favor of the alternative). However, in case of pH level means, we do not reject the null hypothesis and thus we conclude that the pH level means across the three groups are not statistically significantly different. We can even visualize these two features and observe the means using the following snippet.

```
f, (ax1, ax2) = plt.subplots(1, 2, figsize=(10, 4))
f.suptitle('Wine Quality - Alcohol Content/pH', fontsize=14)
f.subplots_adjust(top=0.85, wspace=0.3)

sns.boxplot(x="quality_label", y="alcohol",
            data=wines, ax=ax1)
ax1.set_xlabel("Wine Quality Class", size = 12, alpha=0.8)
ax1.set_ylabel("Wine Alcohol %", size = 12, alpha=0.8)

sns.boxplot(x="quality_label", y="pH", data=wines, ax=ax2)
ax2.set_xlabel("Wine Quality Class", size = 12, alpha=0.8)
ax2.set_ylabel("Wine pH", size = 12, alpha=0.8)
```

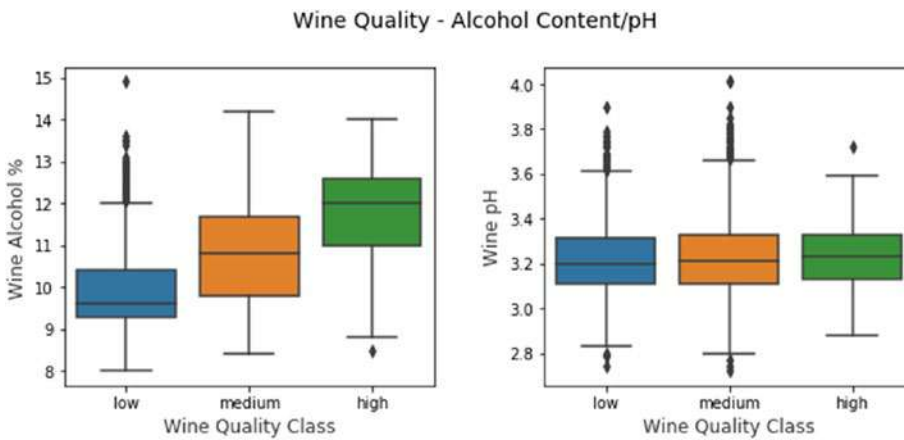

**Figure 9-4.** Visualizing wine alcohol content and pH level distributions based on quality ratings

The boxplots depicted in Figure 9-4 show us stark differences in wine alcohol content distributions based on wine quality as compared to pH levels, which look to be between 3.1 - 3.3 and in fact if you look at the mean and median values for pH levels across the three groups, it is approximately 3.2 across the three groups as compared to alcohol %, which varies significantly. Can you find our more interesting patterns and hypothesis with other features from this data? Give it a try!

## Univariate Analysis

This is perhaps one of the easiest yet a core foundational step in exploratory data analysis. Univariate analysis involves analyzing data such that at any instance of analysis we are only dealing with one variable or feature. No relationships or correlations are analyzed among multiple variables. The simplest way to easily visualize all the variables in your data is to build some histograms. The following snippet helps visualize distributions of data values for all features. While histogram may not be an appropriate visualization in many cases, it is a good one to start with for numeric data.

```
red_wine.hist(bins=15, color='red', edgecolor='black', linewidth=1.0,
             xlabelsize=8, ylabelsize=8, grid=False)
plt.tight_layout(rect=(0, 0, 1.2, 1.2))
rt = plt.suptitle('Red Wine Univariate Plots', x=0.65, y=1.25, fontsize=14)
```

```
white_wine.hist(bins=15, color='white', edgecolor='black', linewidth=1.0,
               xlabelsize=8, ylabelsize=8, grid=False)
plt.tight_layout(rect=(0, 0, 1.2, 1.2))
wt = plt.suptitle('White Wine Univariate Plots', x=0.65, y=1.25, fontsize=14)
```



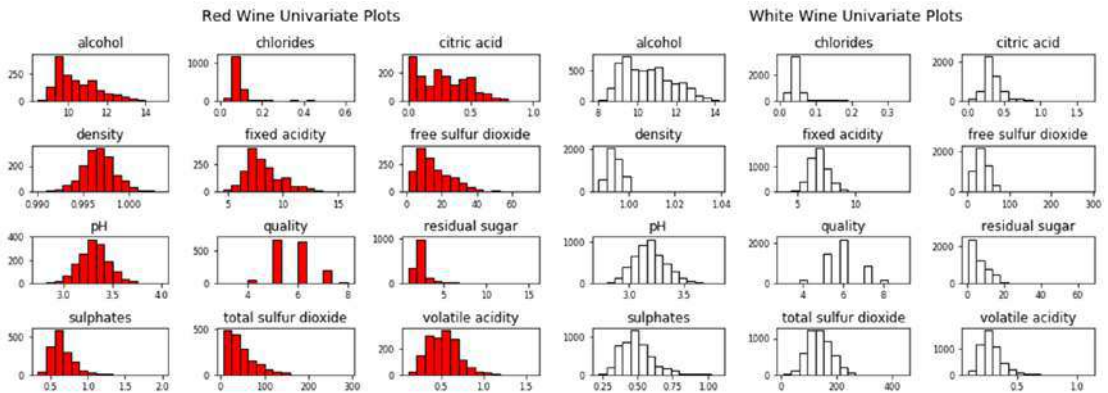

**Figure 9-5.** Univariate plots depicting feature distributions for the wine quality dataset

The power of packages like `matplotlib` and `pandas` enable you to easily plot variable distributions as depicted in Figure 9-5 using minimal code. Do you notice any interesting patterns across the two wine types? Let's take the feature named `residual_sugar` and plot the distributions across data pertaining to red and white wine samples.

```
fig = plt.figure(figsize = (10,4))
title = fig.suptitle("Residual Sugar Content in Wine", fontsize=14)
fig.subplots_adjust(top=0.85, wspace=0.3)

ax1 = fig.add_subplot(1,2, 1)
ax1.set_title("Red Wine")
ax1.set_xlabel("Residual Sugar")
ax1.set_ylabel("Frequency")
ax1.set_ylim([0, 2500])
ax1.text(8, 1000, r'$\mu$='+str(round(red_wine['residual sugar'].mean(),2)),
         fontsize=12)
r_freq, r_bins, r_patches = ax1.hist(red_wine['residual sugar'], color='red', bins=15,
                                     edgcolor='black', linewidth=1)

ax2 = fig.add_subplot(1,2, 2)
ax2.set_title("White Wine")
ax2.set_xlabel("Residual Sugar")
ax2.set_ylabel("Frequency")
ax2.set_ylim([0, 2500])
ax2.text(30, 1000, r'$\mu$='+str(round(white_wine['residual sugar'].mean(),2)),
         fontsize=12)
w_freq, w_bins, w_patches = ax2.hist(white_wine['residual sugar'], color='white', bins=15,
                                     edgcolor='black', linewidth=1)
```

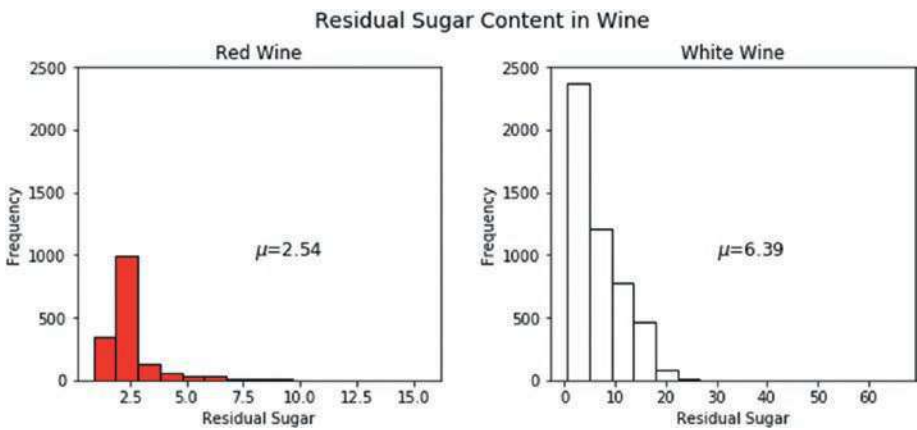

**Figure 9-6.** Residual sugar distribution for red and white wine samples

We can notice easily from the visualization in Figure 9-6 that residual sugar content in white wine samples seems to be more as compared to red wine samples. You can reuse the plotting template in the preceding code snippet and visualize more features. Some plots are depicted as follows (detailed code is present in the jupyter notebook).

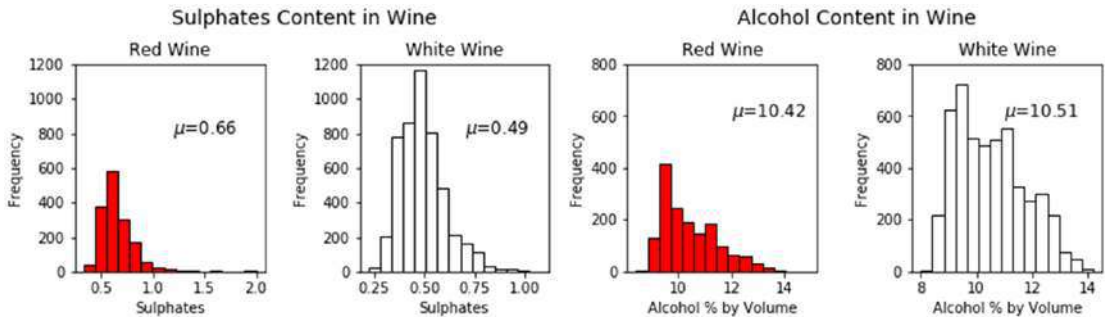

**Figure 9-7.** Distributions for sulphate content and alcohol content for red and white wine samples

The plots depicted in Figure 9-7 show us that the sulphate content is slightly more in red wine samples as compared to white wine samples and alcohol content is almost similar in both types on an average. Of course, frequency counts are higher in all cases for white wine because we have more white wine sample records as compared to red wine. Next, we plot the distributions of the quality and quality\_label categorical features to get an idea of the class distributions, which we will be predicting later on.

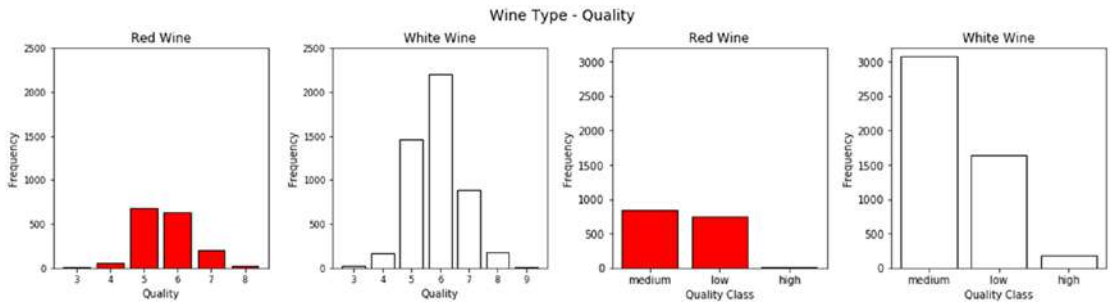

**Figure 9-8.** Distributions for wine quality for red and white wine samples

The bar plots depicted in Figure 9-8 show us the distribution of wine samples based on type and quality. It is quite evident that high quality wine samples are far less as compared to low and medium quality wine samples.

## Multivariate Analysis

Analyzing multiple feature variables and their relationships is what multivariate analysis is all about. We would want to see if there are any interesting patterns and relationships among the physicochemical attributes of our wine samples, which might be helpful in our modeling process in the future. One of the best ways to analyze features is to build a pairwise correlation plot depicting the correlation coefficient between each pair of features in the dataset. The following snippet helps us build a correlation matrix and plot the same in the form of an easy-to-interpret heatmap.

```
f, ax = plt.subplots(figsize=(10, 5))
corr = wines.corr()
hm = sns.heatmap(round(corr,2), annot=True, ax=ax, cmap="coolwarm", fmt='.2f',
                  linewidths=.05)
f.subplots_adjust(top=0.93)
t = f.suptitle('Wine Attributes Correlation Heatmap', fontsize=12)
```

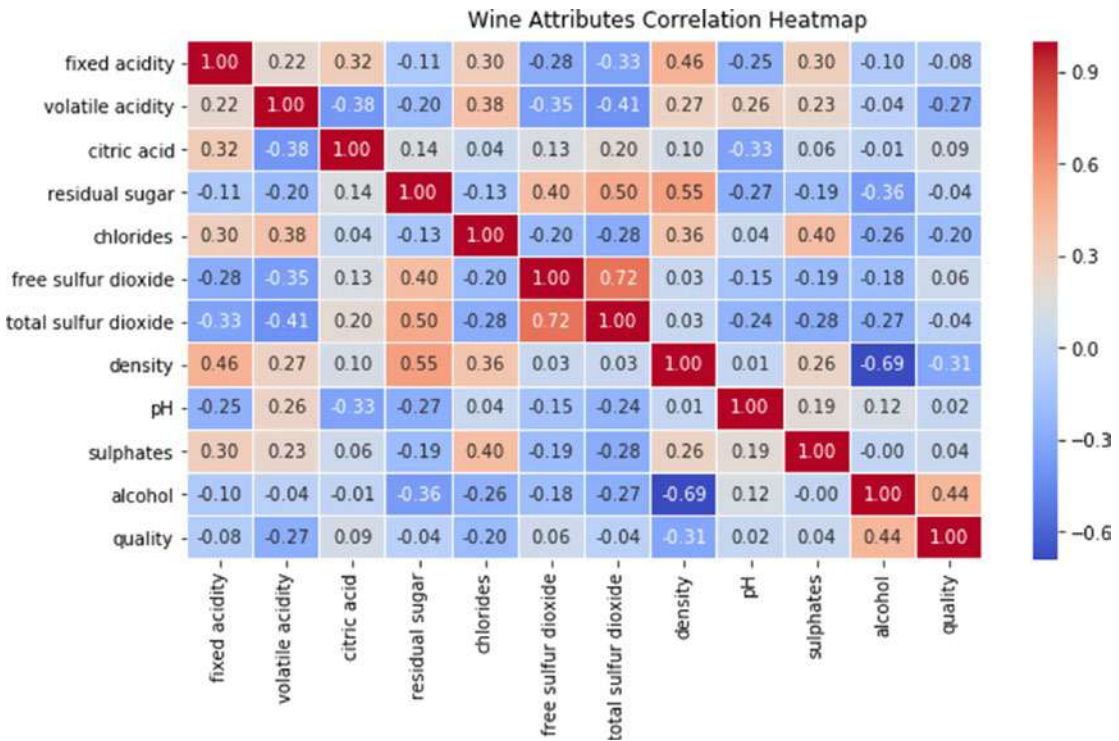

**Figure 9-9.** Correlation heatmap for features in the wine quality dataset

While most of the correlations are weak, as observed in Figure 9-9, we can see a strong negative correlation between density and alcohol and a strong positive correlation between total and free sulfur dioxide, which is expected. You can also visualize patterns and relationships among multiple variables using pairwise plots and use different hues for the wine types essentially plotting three variables at a time. The following snippet depicts a sample pairwise plot for some features in our dataset.

```
cols = ['wine_type', 'quality', 'sulphates', 'volatile acidity']
pp = sns.pairplot(wines[cols], hue='wine_type', size=1.8, aspect=1.8,
                 palette={"red": "#FF9999", "white": "#FFE888"},
                 plot_kws=dict(edgecolor="black", linewidth=0.5))
fig = pp.fig
fig.subplots_adjust(top=0.93, wspace=0.3)
t = fig.suptitle('Wine Attributes Pairwise Plots', fontsize=14)
```

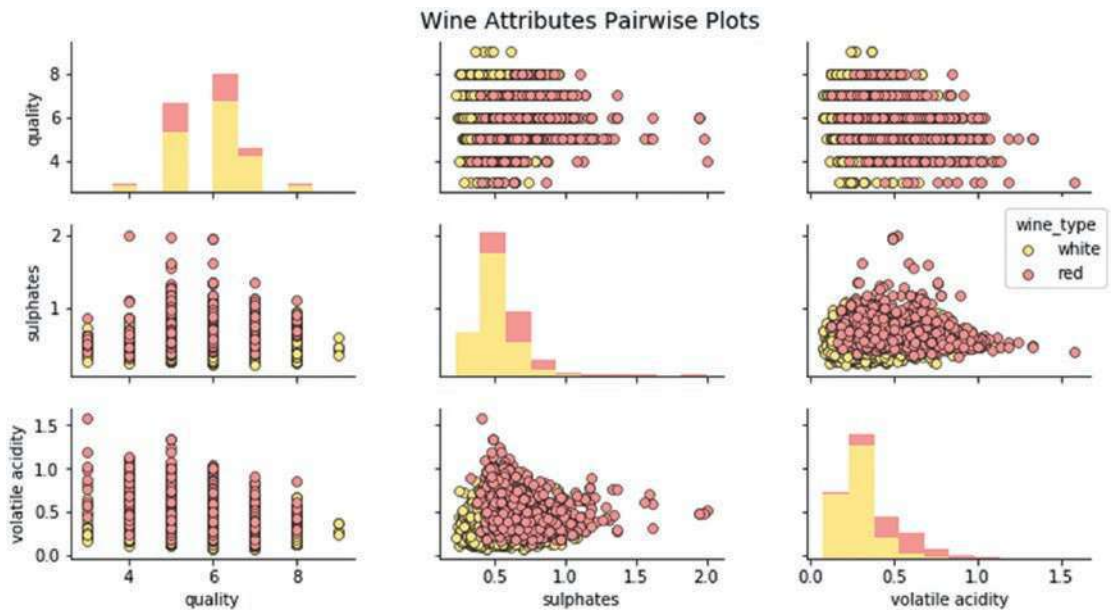

**Figure 9-10.** Pairwise plots by wine type for features in the wine quality dataset

From the plots in Figure 9-10, we can notice several interesting patterns, which are in alignment with some insights we obtained earlier. These observations include the following:

- Presence of higher sulphate levels in red wines as compared to white wines
- Lower sulphate levels in wines with high quality ratings
- Lower levels of volatile acids in wines with high quality ratings
- Presence of higher volatile acid levels in red wines as compared to white wines

You can use similar plots on other variables and features to discover more patterns and relationships. To observe relationships among features with a more microscopic view, joint plots are excellent visualization tools specifically for multivariate visualizations. The following snippet depicts the relationship between wine types, sulphates, and quality ratings.

```

rj = sns.jointplot(x='quality', y='sulphates', data=red_wine,
                  kind='reg', ylim=(0, 2),
                  color='red', space=0, size=4.5, ratio=4)
rj.ax_joint.set_xticks(list(range(3,9)))
fig = rj.fig
fig.subplots_adjust(top=0.9)
t = fig.suptitle('Red Wine Sulphates - Quality', fontsize=12)

wj = sns.jointplot(x='quality', y='sulphates', data=white_wine,
                  kind='reg', ylim=(0, 2),
                  color='#FFE160', space=0, size=4.5, ratio=4)
wj.ax_joint.set_xticks(list(range(3,10)))
fig = wj.fig
fig.subplots_adjust(top=0.9)
t = fig.suptitle('White Wine Sulphates - Quality', fontsize=12)

```

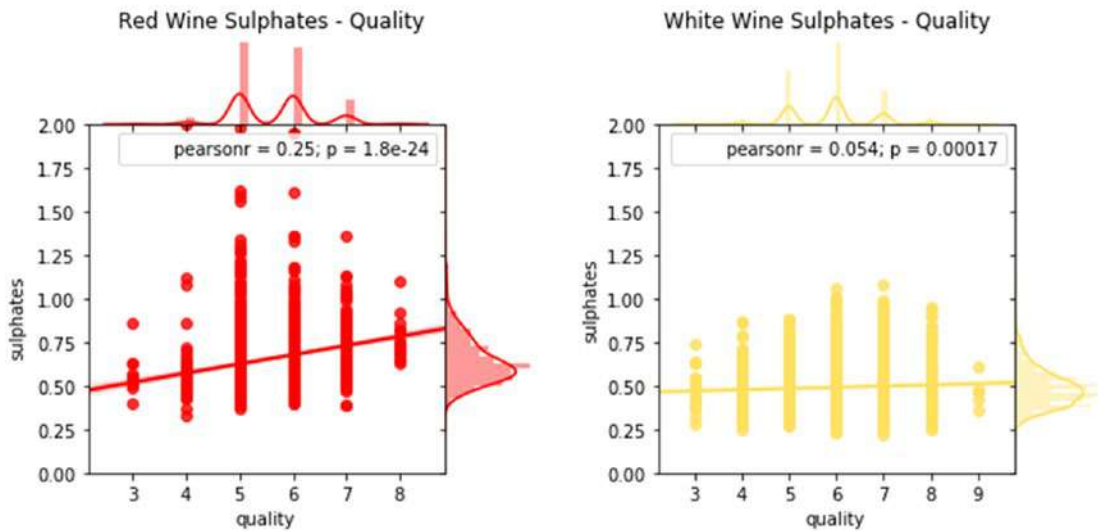

**Figure 9-11.** Visualizing relationships between wine types' sulphates and quality with joint plots

While there seems to be some pattern depicting lower sulphate levels for higher quality rated wine samples, the correlation is quite weak (see Figure 9-11). However, we do see clearly that sulphate levels for red wine are much higher as compared to the ones in white wine. In this case we have visualized three features (type, quality, and sulphates) with the help of two plots. What if we wanted to visualize a higher number of features and determine patterns from them? The seaborn framework provides facet grids that help us visualize higher number of variables in two-dimensional plots. Let's try to visualize relationships between wine type, quality ratings, volatile acidity, and alcohol volume levels.

```
g = sns.FacetGrid(wines, col="wine_type", hue='quality_label',
                  col_order=['red', 'white'], hue_order=['low', 'medium', 'high'],
                  aspect=1.2, size=3.5, palette=sns.light_palette('navy', 3))
g.map(plt.scatter, "volatile acidity", "alcohol", alpha=0.9,
      edgcolor='white', linewidth=0.5)
fig = g.fig
fig.subplots_adjust(top=0.8, wspace=0.3)
fig.suptitle('Wine Type - Alcohol - Quality - Acidity', fontsize=14)
l = g.add_legend(title='Wine Quality Class')
```

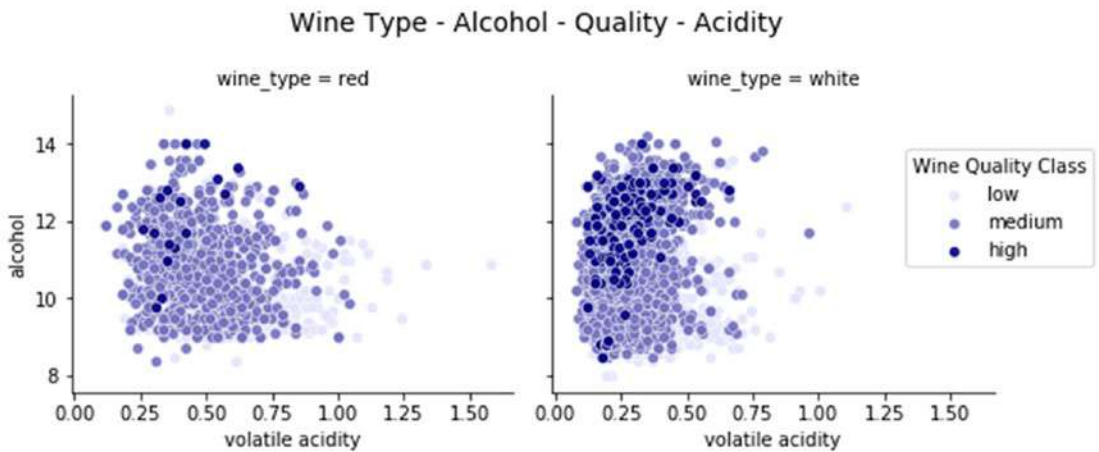
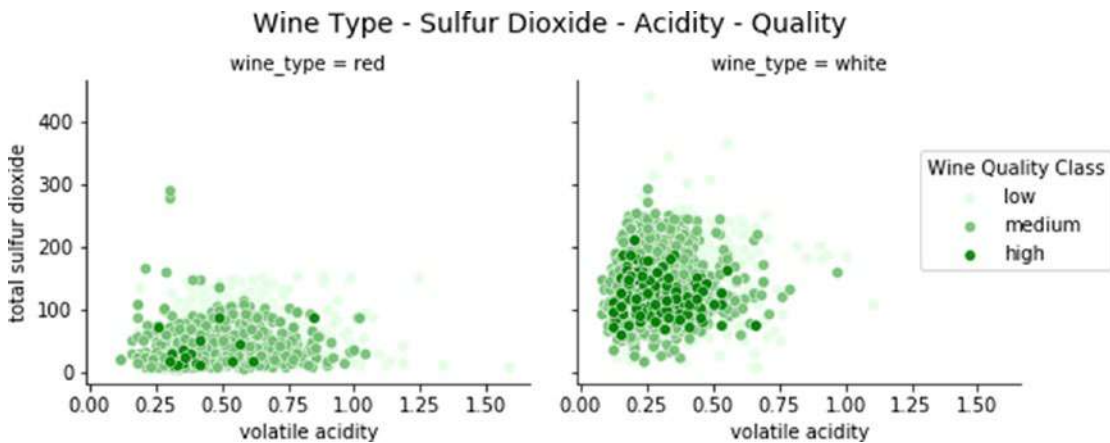

**Figure 9-12.** Visualizing relationships between wine types: alcohol, quality, and acidity levels

The plot in Figure 9-12 shows us some interesting patterns. Not only are we able to successfully visualize four variables, but also we can see meaningful relationships among them. Higher quality wine samples (depicted by darker shades) have lower levels of volatile acidity and higher levels of alcohol content as compared to wine samples with medium and low ratings. Besides this, we can also see that volatile acidity levels are slightly lower in white wine samples as compared to red wine samples.

Let's now build a similar visualization. However, in this scenario, we want to analyze patterns in wine types, quality, sulfur dioxide, and acidity levels. We can use the same framework as our last code snippet to achieve this.

```
g = sns.FacetGrid(wines, col="wine_type", hue='quality_label',
                  col_order=['red', 'white'], hue_order=['low', 'medium', 'high'],
                  aspect=1.2, size=3.5, palette=sns.light_palette('green', 3))
g.map(plt.scatter, "volatile acidity", "total sulfur dioxide", alpha=0.9,
      edgecolor='white', linewidth=0.5)
fig = g.fig
fig.subplots_adjust(top=0.8, wspace=0.3)
fig.suptitle('Wine Type - Sulfur Dioxide - Acidity - Quality', fontsize=14)
l = g.add_legend(title='Wine Quality Class')
```



**Figure 9-13.** Visualizing relationships between wine types: quality, sulfur dioxide, and acidity levels

We can easily interpret from Figure 9-13 that volatile acidity as well as total sulfur dioxide is considerably lower in high quality wine samples. Also, total sulfur dioxide is considerably more in white wine samples as compared to red wine samples. However, volatile acidity levels are slightly lower in white wine samples as compared to red wine samples we also observed in the previous plot.

A nice way to visualize numerical features segmented by groups (categorical variables) is to use box plots. In our dataset, we have already discussed the relationship of higher alcohol levels with higher quality ratings for wine samples in the “Inferential Statistics” section. Let’s try to visualize the relationship between wine alcohol levels grouped by wine quality ratings. We will generate two plots for wine alcohol content versus both wine quality and quality\_label.

```
f, (ax1, ax2) = plt.subplots(1, 2, figsize=(14, 4))
f.suptitle('Wine Type - Quality - Alcohol Content', fontsize=14)

sns.boxplot(x="quality", y="alcohol", hue="wine_type",
            data=wines, palette={"red": "#FF9999", "white": "white"}, ax=ax1)
ax1.set_xlabel("Wine Quality",size = 12,alpha=0.8)
ax1.set_ylabel("Wine Alcohol %",size = 12,alpha=0.8)

sns.boxplot(x="quality_label", y="alcohol", hue="wine_type",
            data=wines, palette={"red": "#FF9999", "white": "white"}, ax=ax2)
ax2.set_xlabel("Wine Quality Class",size = 12,alpha=0.8)
ax2.set_ylabel("Wine Alcohol %",size = 12,alpha=0.8)
l = plt.legend(loc='best', title='Wine Type')
```



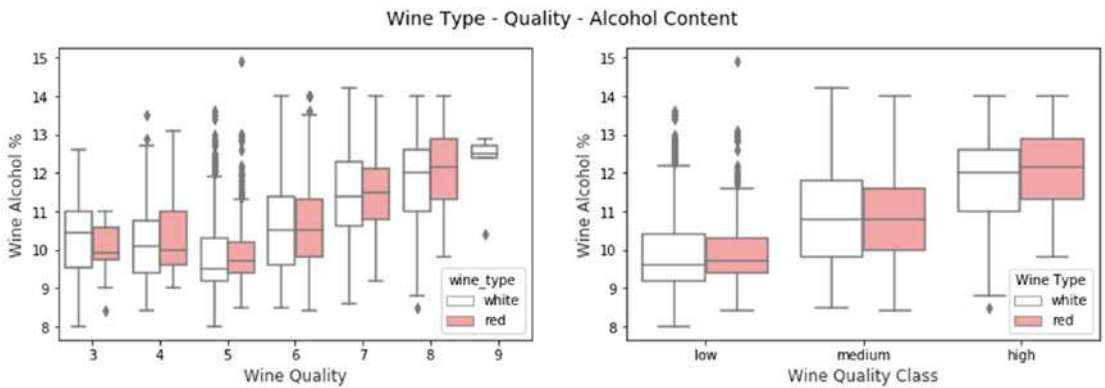

**Figure 9-14.** Visualizing relationships between wine types: quality and alcohol content

Based on our earlier analysis for wine quality versus alcohol volume in the “Inferential Statistics” section, these results look consistent. Each box plot in Figure 9-14 depicts the distribution of alcohol level for a particular wine quality rating separated by wine types. The box itself depicts the inter-quartile range and the line inside depicts the median value of alcohol. Whiskers indicate the minimum and maximum value with outliers often depicted by individual points. We can clearly observe the wine alcohol by volume distribution has an increasing trend based on higher quality rated wine samples. Similarly we can also use violin plots to visualize distributions of numeric features over categorical features. Let’s build a visualization for analyzing the fixed acidity of wine sample by quality ratings.

```
f, (ax1, ax2) = plt.subplots(1, 2, figsize=(14, 4))
f.suptitle('Wine Type - Quality - Acidity', fontsize=14)

sns.violinplot(x="quality", y="volatile acidity", hue="wine_type",
               data=wines, split=True, inner="quart", linewidth=1.3,
               palette={"red": "#FF9999", "white": "white"}, ax=ax1)
ax1.set_xlabel("Wine Quality", size = 12, alpha=0.8)
ax1.set_ylabel("Wine Fixed Acidity", size = 12, alpha=0.8)

sns.violinplot(x="quality_label", y="volatile acidity", hue="wine_type",
               data=wines, split=True, inner="quart", linewidth=1.3,
               palette={"red": "#FF9999", "white": "white"}, ax=ax2)
ax2.set_xlabel("Wine Quality Class", size = 12, alpha=0.8)
ax2.set_ylabel("Wine Fixed Acidity", size = 12, alpha=0.8)
l = plt.legend(loc='upper right', title='Wine Type')
```

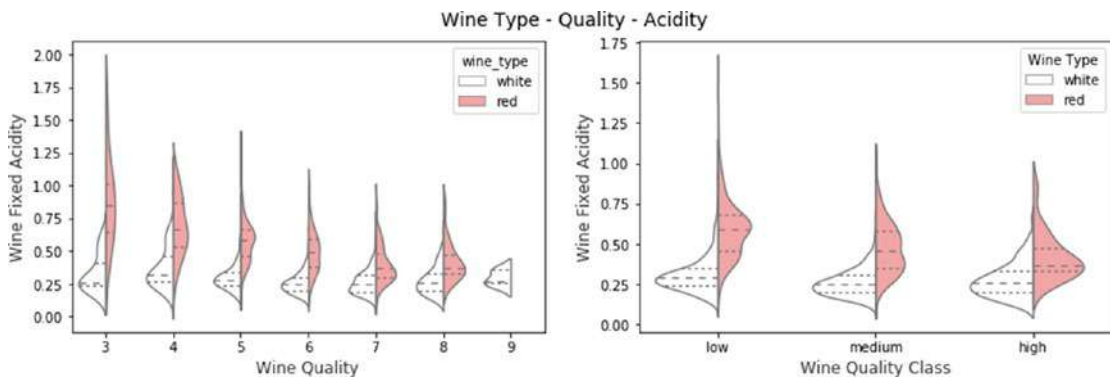

**Figure 9-15.** Visualizing relationships between wine types: quality and acidity

In Figure 9-15, Each violin plot typically depicts the inter-quartile range with the median which is shown with dotted lines in this figure. You can also visualize the distribution of data with the density plots where width depicts frequency. Thus in addition to the information you get from box plots, you can also visualize the distribution of data with violin plots. In fact we have built a split-violin plot in this case depicting both types of wine. It is quite evident that red wine samples have higher acidity as compared to its white wine counterparts. Also we can see an overall decrease in acidity with higher quality wine for red wine samples but not so much for white wine samples. These code snippets and examples should give you some good frameworks and blueprints to perform effective exploratory data analysis on your datasets in the future.

## Predictive Modeling

We will now focus on our main objectives of building predictive models to predict the wine types and quality ratings based on other features. We will be following the standard classification Machine Learning pipeline in this case. There will be two main classification systems we will be building in this section.

- Prediction system for **wine type** (red or white wine)
- Prediction system for **wine quality rating** (low, medium, or high)

We will be using the wines data frame from the previous sections. The entire code for this section is available in the Python file titled `predictive_analytics.py` or you can use the jupyter notebook titled `Predictive Analytics.ipynb` for a more interactive experience. To start with, let's load the following necessary dependencies and settings.

```
import pandas as pd
import numpy as np
import matplotlib.pyplot as plt
import model_evaluation_utils as meu
from sklearn.model_selection import train_test_split
from collections import Counter
from sklearn.preprocessing import StandardScaler
from sklearn.preprocessing import LabelEncoder

%matplotlib inline
```

Do remember to have the `model_evaluation_utils.py` module in the same directory where you are running your code since we will be using it for evaluating our predictive models. Let's briefly look at the workflow we will be following for our predictive systems. We will focus on two major phases—*model training* and model predictions and evaluation.

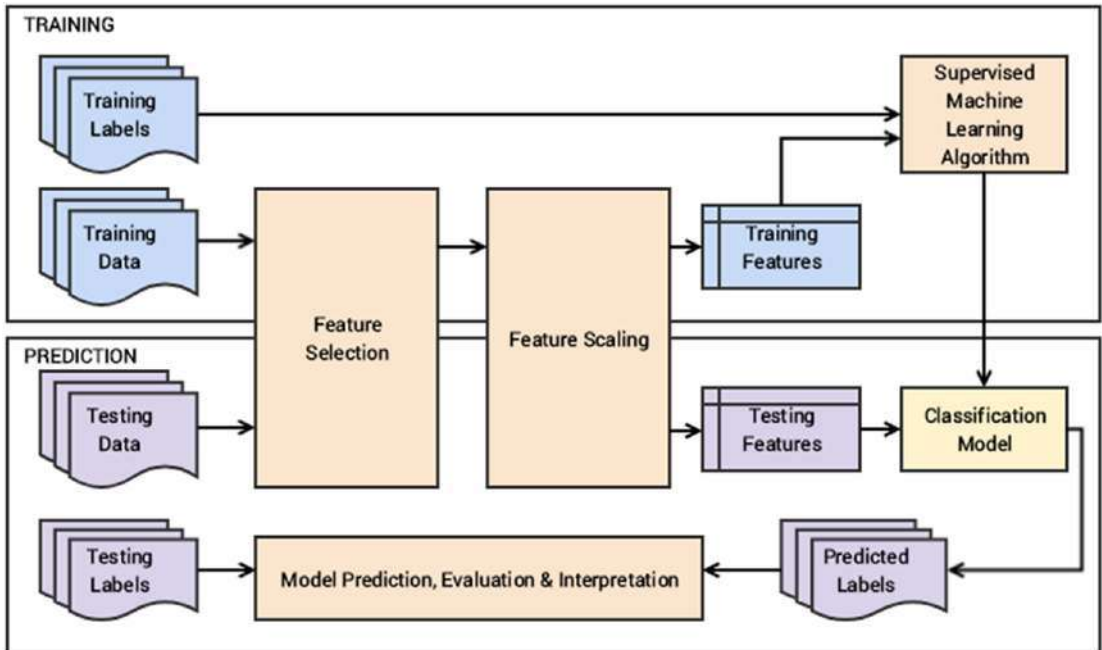

**Figure 9-16.** Workflow blueprint for our wine type and quality classification system

From Figure 9-16, we can see that training data and testing data refer to the wine quality dataset features. Since we already have the necessary wine attributes, we won't be building additional hand-crafted features. Labels can be either wine types or quality ratings based on the classification system. In the training phase, feature selection will mostly involve selecting all the necessary wine physicochemical attributes and then after necessary scaling we will be training our predictive models for prediction and evaluation in the prediction phase.

## Predicting Wine Types

In our wine quality dataset, we have two variants or types of wine—red and white wine. The main task of our classification system in this section is to predict the wine type based on other features. To start with, we will first select our necessary features and separate out the prediction class labels and prepare train and test datasets. We use the prefix `wtp_` in our variables to easily identify them as needed, where `wtp` depicts wine type prediction.

```
In [5]: wtp_features = wines.iloc[:, :-3]
...: wtp_feature_names = wtp_features.columns
...: wtp_class_labels = np.array(wines['wine_type'])
...:
```

```

...: wtp_train_X, wtp_test_X, wtp_train_y, wtp_test_y = train_test_split(wtp_features,
...:                                     wtp_class_labels, test_size=0.3, random_state=42)
...:
...: print(Counter(wtp_train_y), Counter(wtp_test_y))
...: print('Features:', list(wtp_feature_names))
Counter({'white': 3418, 'red': 1129}) Counter({'white': 1480, 'red': 470})
Features: ['fixed acidity', 'volatile acidity', 'citric acid', 'residual sugar', 'chlorides',
'free sulfur dioxide', 'total sulfur dioxide', 'density', 'pH', 'sulphates', 'alcohol']

```

The numbers show us the wine samples for each class and we can also see the feature names which will be used in our feature set. Let’s move on to scaling our features. We will be using a standard scaler in this scenario.

```

In [6]: # Define the scaler
...: wtp_ss = StandardScaler().fit(wtp_train_X)
...: # Scale the train set
...: wtp_train_SX = wtp_ss.transform(wtp_train_X)
...: # Scale the test set
...: wtp_test_SX = wtp_ss.transform(wtp_test_X)

```

Since we are dealing with a binary classification problem, one of the traditional Machine Learning algorithms we can use is the logistic regression model. If you remember we had talked about this in detail in Chapter 7. Feel free to skim through the “Traditional Supervised Machine Learning Models” section in Chapter 7 to refresh your memory on logistic regression or you can refer to any standard text book or material on classification models. Let’s now train a model on our training dataset and labels using logistic regression

```

In [7]: from sklearn.linear_model import LogisticRegression
...:
...: wtp_lr = LogisticRegression()
...: wtp_lr.fit(wtp_train_SX, wtp_train_y)
Out[7]:
LogisticRegression(C=1.0, class_weight=None, dual=False, fit_intercept=True,
intercept_scaling=1, max_iter=100, multi_class='ovr', n_jobs=1,
penalty='l2', random_state=None, solver='liblinear', tol=0.0001,
verbose=0, warm_start=False)

```

Now that our model is ready, let’s predict the wine types for our test data samples and evaluate the performance.

```

In [8]: wtp_lr_predictions = wtp_lr.predict(wtp_test_SX)
...: meu.display_model_performance_metrics(true_labels=wtp_test_y,
...:                                     predicted_labels=wtp_lr_predictions, classes=['red', 'white'])

```

Model Performance metrics:	Model Classification report:				Prediction Confusion Matrix:		
Accuracy: 0.9923		precision	recall	f1-score	support	Predicted:	
Precision: 0.9923						red	white
Recall: 0.9923	red	0.98	0.99	0.98	470	Actual: red	463 7
F1 Score: 0.9923	white	1.00	0.99	0.99	1480	white	8 1472
	avg / total	0.99	0.99	0.99	1950		

**Figure 9-17.** Model performance metrics for logistic regression for wine type predictive model

We get an overall **F1 Score** and model **accuracy** of **99.2%**, as depicted in Figure 9-17 which is really amazing! In spite of low samples of red wine, we seem to do pretty well. In case your models do not perform well on other datasets due to a class imbalance problem, you can consider over-sampling or under-sampling techniques including sample selection as well as SMOTE. Coming back to our classification problem, we have a really good model, but can we do better? While that seems to be a far-fetched dream, let's try modeling the data using a fully connected deep neural network (DNN) with three hidden layers. Refer to the "Newer Supervised Deep Learning Models" section in Chapter 7 to refresh your memory on fully-connected DNNs and MLPs. Deep Learning frameworks like keras on top of tensorflow prefer if your output response labels are encoded to numeric forms which are easier to work with. The following snippet encodes our wine type class labels.

```
In [9]: le = LabelEncoder()
...: le.fit(wtp_train_y)
...: # encode wine type labels
...: wtp_train_ey = le.transform(wtp_train_y)
...: wtp_test_ey = le.transform(wtp_test_y)
```

Let's build the architecture for our three-hidden layer DNN where each hidden layer has 16 units (the input layer has 11 units for the 11 features) and the output layer has 1 unit to predict a 0 or 1, which maps back to red or white wine.

```
In [10]: from keras.models import Sequential
...: from keras.layers import Dense
...:
...: wtp_dnn_model = Sequential()
...: wtp_dnn_model.add(Dense(16, activation='relu', input_shape=(11,)))
...: wtp_dnn_model.add(Dense(16, activation='relu'))
...: wtp_dnn_model.add(Dense(16, activation='relu'))
...: wtp_dnn_model.add(Dense(1, activation='sigmoid'))
...:
...: wtp_dnn_model.compile(loss='binary_crossentropy', optimizer='adam',
metrics=['accuracy'])
Using TensorFlow backend.
```

You can see that we are using keras on top of tensorflow, and for our optimizer, we have chosen the adam optimizer with a binary cross-entropy loss. You can also use categorical cross-entropy if needed, which is especially useful when you have more than two classes. The following snippet helps train our DNN.

```
In [11]: history = wtp_dnn_model.fit(wtp_train_SX, wtp_train_ey, epochs=10, batch_size=5,
...:                                 shuffle=True, validation_split=0.1, verbose=1)
Train on 4092 samples, validate on 455 samples
Epoch 1/10 4092/4092 - 1s - loss: 0.1266 - acc: 0.9467 - val_loss: 0.0115 - val_acc: 0.9978
Epoch 2/10 4092/4092 - 1s - loss: 0.0315 - acc: 0.9934 - val_loss: 0.0046 - val_acc: 1.0000
...
Epoch 9/10 4092/4092 - 1s - loss: 0.0112 - acc: 0.9973 - val_loss: 0.0029 - val_acc: 1.0000
Epoch 10/10 4092/4092 - 1s - loss: 0.0098 - acc: 0.9978 - val_loss: 0.0013 - val_acc: 1.0000
```

We use 10% of the training data for a validation set while training the model to see how it performs at each epoch. Let's now predict and evaluate our model on the actual test dataset.

```
In [15]: wtp_dnn_ypred = wtp_dnn_model.predict_classes(wtp_test_SX)
...: wtp_dnn_predictions = le.inverse_transform(wtp_dnn_ypred)
...: meu.display_model_performance_metrics(true_labels=wtp_test_y,
...:                                     predicted_labels=wtp_dnn_predictions, classes=['red', 'white'])
```

Model Performance metrics:	Model Classification report:				Prediction Confusion Matrix:		
Accuracy: 0.9954		precision	recall	f1-score	support	Predicted:	
Precision: 0.9954	red	1.00	0.99	0.99	470	red	white
Recall: 0.9954	white	1.00	1.00	1.00	1480	463	7
F1 Score: 0.9954	avg / total	1.00	1.00	1.00	1950	white	2 1478

Figure 9-18. Model performance metrics for deep neural network for wine type predictive model

We get an overall **F1 Score** and model **accuracy** of **99.5%**, as depicted in Figure 9-18, which is even better than our previous model! This goes to prove you don't always need big data but good quality data and features even for Deep Learning models. The loss and accuracy measures at each epoch are depicted in Figure 9-19, with the detailed code present in the notebook.

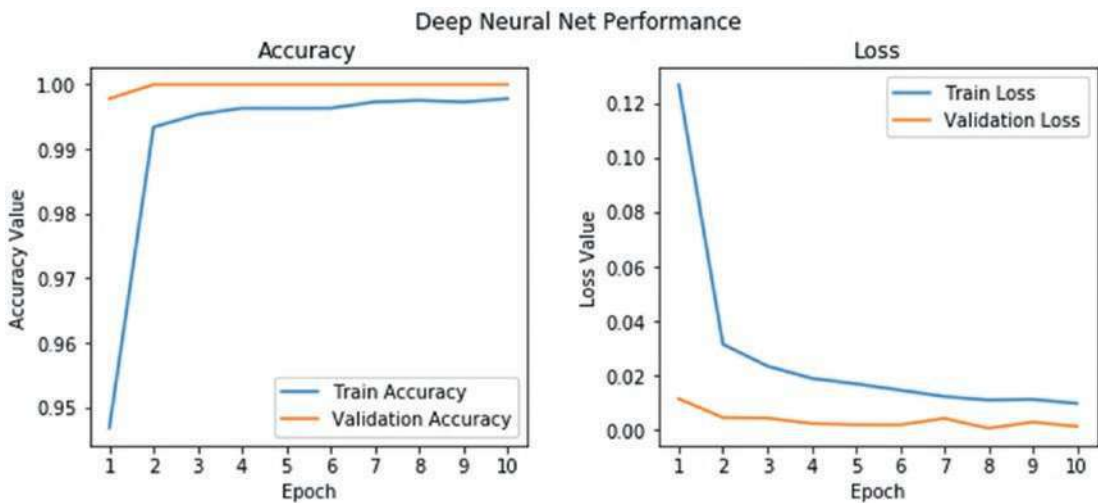
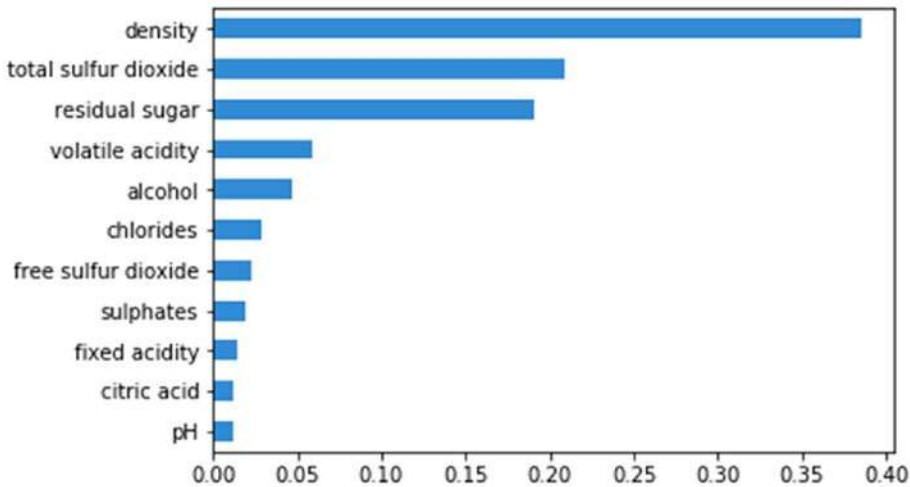

Figure 9-19. Model performance metrics for DNN model per epoch

Now that we have a working wine type classification system, let's try to interpret one of these predictive models. One of the key aspects in model interpretation is to try to understand the importance of each feature from the dataset. We will be using the `skater` package that we used in the previous chapters for our model interpretation needs. The following code helps visualize feature importances for our logistic regression model.

```
In [16]: from skater.core.explanations import Interpretation
...: from skater.model import InMemoryModel
...:
...: wtp_interpreter = Interpretation(wtp_test_SX, feature_names=wtp_features.columns)
...: wtp_im_model = InMemoryModel(wtp_lr.predict_proba, examples=wtp_train_SX,
...:                             target_names=wtp_lr.classes_)
...: plots = wtp_interpreter.feature_importance.plot_feature_importance(wtp_im_model,
...:                                                                     ascending=False)
```

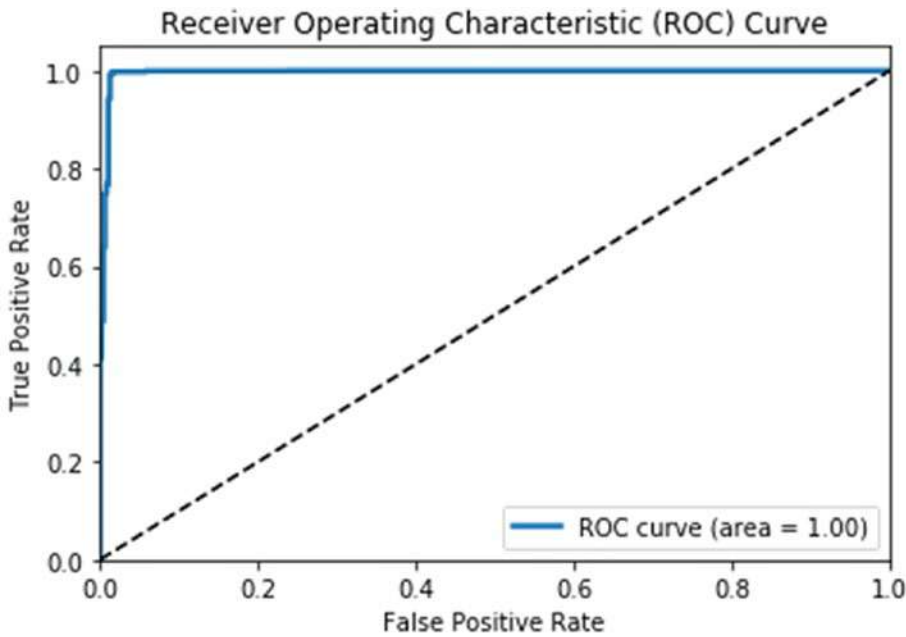

**Figure 9-20.** Feature importances obtained from our logistic regression model

We can see in Figure 9-20 that density, total sulfur dioxide, and residual sugar are the top three features that contributed toward classifying wine samples as red or white. Another way of understanding how well a model is performing besides looking at metrics is to plot a receiver operating characteristics curve also known popularly as a ROC curve. This curve can be plotted using the true positive rate (TPR) and the false positive rate (FPR) of a classifier. TPR is known as sensitivity or recall, which is the total number of correct positive results predicted among all the positive samples in the dataset. FPR is known as false alarms or  $(1 - \text{specificity})$ , determining the total number of incorrect positive predictions among all negative samples in the dataset. The ROC curve is also known as a sensitivity versus  $(1 - \text{specificity})$  plot sometimes. The following code uses our model evaluation utilities module to plot the ROC curve for our logistic regression model in the ROC space.

```
In [17]: meu.plot_model_roc_curve(wtp_lr, wtp_test_SX, wtp_test_y)
```

Typically in any ROC curve, the ROC space is between points (0,0) and (1, 1). Each prediction result from the confusion matrix occupies one point in this ROC space. Ideally, the best prediction model would give a point on the top-left corner (0,1) indicating perfect classification (100% sensitivity and specificity). A diagonal line depicts a classifier that does a random guess. Ideally if your ROC curve occurs in the top half of the graph, you have a decent classifier, which is better than average. Figure 9-21 makes this clearer.



**Figure 9-21.** ROC curve for our logistic regression model

We achieved almost 100% accuracy if you remember for this model and hence the ROC curve is almost perfect where we also see that the area under curve (AUC) is 1 which is perfect. Finally, from our feature importance ranks we obtained earlier, let's see if we can visualize the model's decision surface or decision boundary, which basically gives us a visual depiction of how well the model is able to learn data points pertaining to each class and separate points belonging to different classes. This surface is basically the hypersurface, which helps in separating the underlying vector space of data samples based on their features (feature space). If this surface is linear, the classification problem is linear and the hypersurface is also known as a hyperplane. Our model evaluation utilities module helps us plot this with the help of an easy-to-use function (do note this works only for scikit estimators at the moment since there was no clone function for keras based estimators and it just got published last month as of writing this book; we might push a change sometime in the future once it is stable).

```
In [18]: feature_indices = [i for i, feature in enumerate(wtp_feature_names)
...:                       if feature in ['density', 'total sulfur dioxide']]
...: meu.plot_model_decision_surface(clf=wtp_lr,
...:                                train_features=wtp_train_SX[:, feature_indices],
...:                                train_labels=wtp_train_y, plot_step=0.02,
...:                                cmap=plt.cm.Wistia_r, markers=['.', 'o'],
...:                                alphas=[0.9, 0.6], colors=['r', 'y'])
```

Since we would want to plot the decision surface on the underlying feature space, visualizing this becomes extremely difficult when you have more than two features. Hence for the sake of simplicity and ease of interpretation, we will use the top two most important features (density and total sulfur dioxide) to visualize the model decision surface. This is done by fitting a cloned model of the original model estimator on those two features and then plotting the decision surface based on what it has learned. Check out the `plot_model_decision_surface(...)` function for more low-level details on how we visualize the decision surfaces.



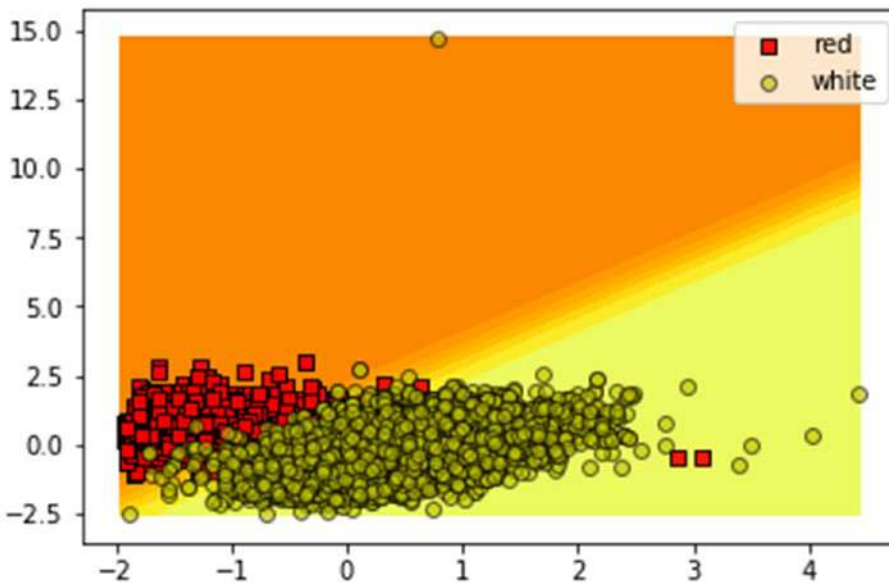

**Figure 9-22.** Visualizing the model decision surface for our logistic regression model

The plot depicted in Figure 9-22 reinforces the fact that our model has learned the underlying patterns quite well based on just the two most important features, which it has used to separate out majority of the red wine samples from the white wine samples depicted by the scatter dots. There are very few misclassifications here and there, which are evident based on the statistics we obtained earlier in the confusion matrices.

## Predicting Wine Quality

In our wine quality dataset, we have several quality rating classes ranging from 3 to 9. What we will be focusing on is the `quality_label` variable that classifies wine into low, medium, and high ratings based on the underlying quality variable based on the mapping we created in the “Exploratory Data Analysis” section. This is done because several rating scores have very few wine samples and hence similar quality ratings were clubbed together into one quality class rating. We use the prefix `wqp_` for all variables and models involved in prediction of wine quality to distinguish it from other analysis. The prefix `wqp` stands for *wine quality prediction*. We will evaluate and look at tree based classification models as well as ensemble models in this section. The following code helps us prepare our train and test datasets for modeling.

```
In [19]: wqp_features = wines.iloc[:, :-3]
...: wqp_class_labels = np.array(wines['quality_label'])
...: wqp_label_names = ['low', 'medium', 'high']
...: wqp_feature_names = list(wqp_features.columns)
...: wqp_train_X, wqp_test_X, wqp_train_y, wqp_test_y = train_test_split(wqp_features,
...:                                                                     wqp_class_labels, test_size=0.3, random_state=42)
...:
...: print(Counter(wqp_train_y), Counter(wqp_test_y))
...: print('Features:', wqp_feature_names)
```

```
Counter({'medium': 2737, 'low': 1666, 'high': 144}) Counter({'medium': 1178, 'low': 718, 'high': 54})
Features: ['fixed acidity', 'volatile acidity', 'citric acid', 'residual sugar', 'chlorides', 'free sulfur dioxide', 'total sulfur dioxide', 'density', 'pH', 'sulphates', 'alcohol']
```

From the preceding output, it is evident we use the same physicochemical wine features. The number of samples in each quality rating class is also depicted. It is quite evident we have very few wine samples of high class rating and a lot of medium quality wine samples. We move on to the next step of feature scaling.

```
In [20]: # Define the scaler
...: wqp_ss = StandardScaler().fit(wqp_train_X)
...: # Scale the train set
...: wqp_train_SX = wqp_ss.transform(wqp_train_X)
...: # Scale the test set
...: wqp_test_SX = wqp_ss.transform(wqp_test_X)
```

Let’s train a tree based model on this data. The Decision Tree Classifier is an excellent example of a classic tree model. This is based on the concept of decision trees, which focus on using a tree-like graph or flowchart to model decisions and their possible outcomes. Each decision node in the tree represents a decision test on a specific data attribute. Edges or branches from each node represent possible outcomes of the decision test. Each leaf node represents a predicted class label. To get all the end-to-end classification rules, you need to consider the paths from the root node to the leaf nodes. Decision tree models in the context of Machine Learning are non-parametric supervised learning methods, which use these decision tree based structures for classification and regression tasks. The core objective is to build a model such that we can predict the value of a target response variable by leveraging decision tree based structures to learn decision rules from the input data features. The main advantage of decision tree based models is model interpretability, since it is quite easy to understand and interpret the decision rules which led to a specific model prediction. Besides this, other advantages include the model’s ability to handle both categorical and numeric data with ease as well as multi-class classification problems. Trees can be even visualized to understand and interpret decision rules better. The following snippet leverages the `DecisionTreeClassifier` estimator to build a decision tree model and predict the wine quality ratings of our wine samples.

```
In [21]: from sklearn.tree import DecisionTreeClassifier
...: # train the model
...: wqp_dt = DecisionTreeClassifier()
...: wqp_dt.fit(wqp_train_SX, wqp_train_y)
...: # predict and evaluate performance
...: wqp_dt_predictions = wqp_dt.predict(wqp_test_SX)
...: meu.display_model_performance_metrics(true_labels=wqp_test_y,
...:                                     predicted_labels=wqp_dt_predictions, classes=wqp_label_names)
```

Model Performance metrics:		Model Classification report:				Prediction Confusion Matrix:				
Accuracy: 0.7297										
Precision: 0.7306		precision	recall	f1-score	support	Predicted:				
Recall: 0.7297		low	0.68	0.69	0.68	718	Actual: low	493	222	3
F1 Score: 0.7302		medium	0.78	0.78	0.78	1178	medium	227	914	37
		high	0.29	0.30	0.29	54	high	5	33	16
		avg / total	0.73	0.73	0.73	1950				

**Figure 9-23.** Model performance metrics for decision tree for wine quality predictive model

We get an overall **F1 Score** and model **accuracy** of approximately **73%**, as depicted in Figure 9-23, which is not bad for a start. Looking at the class based statistics; we can see the recall for the high quality wine samples is pretty bad since a lot of them have been misclassified into medium and low quality ratings. This is kind of expected since we do not have a lot of training samples for high quality wine if you remember our training sample sizes from earlier. Considering low and high quality rated wine samples, we should at least try to see if we can prevent our model from predicting a low quality wine as high and similarly prevent predicting a high quality wine as low. Interpreting this model, you can use the following code to look at the feature importance scores based on the patterns learned by our model.

```
In [22]: wqp_dt_feature_importances = wqp_dt.feature_importances_
...: wqp_dt_feature_names, wqp_dt_feature_scores = zip(*sorted(zip(wqp_feature_names,
...:                                                                wqp_dt_feature_importances), key=lambda x: x[1]))
...: y_position = list(range(len(wqp_dt_feature_names)))
...: plt.barh(y_position, wqp_dt_feature_scores, height=0.6, align='center')
...: plt.yticks(y_position , wqp_dt_feature_names)
...: plt.xlabel('Relative Importance Score')
...: plt.ylabel('Feature')
...: t = plt.title('Feature Importances for Decision Tree')
```

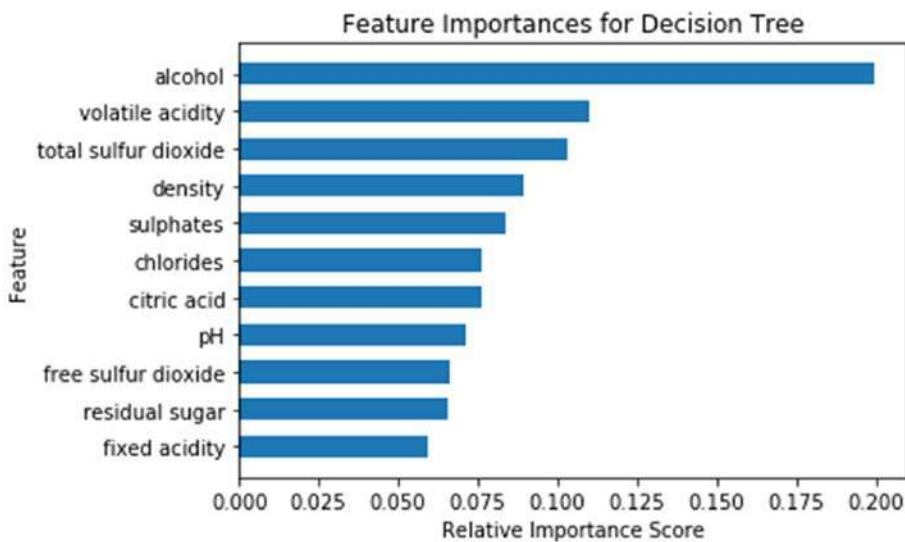

**Figure 9-24.** Feature importances obtained from our decision tree model

We can clearly observe from Figure 9-24 that the most important features have changed as compared to our previous model. Alcohol and volatile acidity occupy the top two ranks and total sulfur dioxide seems to be one of the most important features for classifying both wine type and quality (as observed in Figure 9-20). If you remember, we mentioned earlier that you can also easily visualize the decision tree structure from decision tree models and check out the decision rules that it learned from the underlying features used in prediction for new data samples. The following code helps us visualize decision trees.

```
In [23]: from graphviz import Source
...: from sklearn import tree
...: from IPython.display import Image
...:
...: graph = Source(tree.export_graphviz(wqp_dt, out_file=None, class_names=wqp_label_names,
...:                                   filled=True, rounded=True, special_
...:                                   characters=False,
...:                                   feature_names=wqp_feature_names, max_depth=3))
...: png_data = graph.pipe(format='png')
...: with open('dtree_structure.png', 'wb') as f:
...:     f.write(png_data)
...: Image(png_data)
```

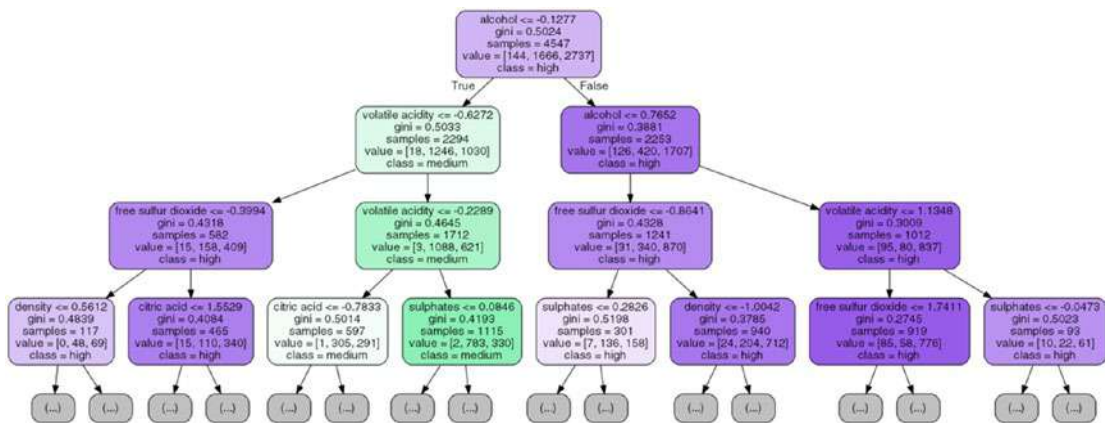

Figure 9-25. Visualizing our decision tree model

Our decision tree model has a huge number of nodes and branches hence we visualized our tree for a max depth of three based on the preceding snippet. You can start observing the decision rules from the tree in Figure 9-25 where the starting split is determined by the rule of `alcohol <= -0.1277` and with each yes/no decision branch split, we have further decision nodes as we descend into the tree at each depth level. The class variable is what we are trying to predict, i.e. wine quality being low, medium, or high and value determines the total number of samples at each class present in the current decision node at each instance. The gini parameter is basically the criterion which is used to determine and measure the quality of the split at each decision node. Best splits can be determined by metrics like gini impurity\gini index or information gain. Just to give you some context, the gini impurity is a metric that helps in minimizing the probability of misclassification. It is usually mathematically denoted as follows,

$$I_G(p) = \sum_{i=1}^C p_i(1-p_i) = 1 - \sum_{i=1}^C p_i^2$$

Where we have  $C$  classes to predict,  $p_i$  is the fraction of items labeled as class  $i$  or the probability measure of instance with class label  $i$  being chosen and  $(1 - p_i)$  is the mistake in categorizing that item or misclassification measure. The gini impurity\index is computed by summing the square of the fraction of classified instances for each class label in the  $C$  classes and subtracting the result from 1. Interested readers can check out some standard literature on decision trees if interested in diving deeper into differences between entropy and gini or to understand more intricate mathematical details.

Moving forward with our mission of improving our wine quality predictive model, let's look at some ensemble modeling methods. Ensemble models are typically Machine Learning models that combine or take a weighted (average\majority) vote of the predictions of each of the individual base model estimators that have been built using supervised methods of their own. The ensemble is expected to generalize better over underlying data, be more robust, and make superior predictions as compared to each individual base model. Ensemble models can be categorized under three major families.

- **Bagging methods:** The term bagging stands for bootstrap aggregating, where the ensemble model tries to improve prediction accuracy by combining predictions of individual base models trained over randomly generated training samples. Bootstrap samples, i.e. independent samples with replacement, are taken from the original training dataset and several base models are built on these sampled datasets. At any instance, an average of all predictions from the individual estimators is taken for the ensemble model to make its final prediction. Random sampling tries to reduce model variance, reduce overfitting, and boost prediction accuracy. Examples include the very popular random forests.
- **Boosting methods:** In contrast to bagging methods, which operate on the principle of combining or averaging, in boosting methods, we build the ensemble model incrementally by training each base model estimator sequentially. Training each model involves putting special emphasis on learning the instances which it previously misclassified. The idea is to combine several weak base learners to form a powerful ensemble. Weak learners are trained sequentially over multiple iterations of the training data with weight modifications inserted at each retrain phase. At each re-training of a weak base learner, higher weights are assigned to those training instances which were misclassified previously. Thus, these methods try to focus on training instances which it wrongly predicted in the previous training sequence. Boosted models are prone to over-fitting so one should be very careful. Examples include Gradient Boosting, AdaBoost, and the very popular XGBoost.
- **Stacking methods:** In stacking based methods, we first build multiple base models over the training data. Then the final ensemble model is built by taking the output predictions from these models as its additional inputs for training to make the final prediction.

Let's now try building a model using random forests, a very popular bagging method. In the random forest model, each base learner is a decision tree model trained on a bootstrap sample of the training data. Besides this, when we want to split a decision node in the tree, the split is chosen from a random subset of all the features instead of taking the best split from all the features. Due to the introduction of this randomness, bias increases and when we average the result from all the trees in the forest, the overall variance decreases, giving us a robust ensemble model which generalizes well. We will be using the `RandomForestClassifier` from `scikit-learn`, which averages the probabilistic prediction from all the trees in the forest for the final prediction instead of taking the actual prediction votes and then averaging it.

```
In [24]: from sklearn.ensemble import RandomForestClassifier
...: # train the model
...: wqp_rf = RandomForestClassifier()
...: wqp_rf.fit(wqp_train_SX, wqp_train_y)
...: # predict and evaluate performance
...: wqp_rf_predictions = wqp_rf.predict(wqp_test_SX)
...: meu.display_model_performance_metrics(true_labels=wqp_test_y,
...:                                     predicted_labels=wqp_rf_predictions,
...:                                     classes=wqp_label_names)
```

Model Performance metrics:	Model Classification report:				Prediction Confusion Matrix:				
Accuracy: 0.7759									
Precision: 0.7741		precision	recall	f1-score	support	Predicted:			
Recall: 0.7759	low	0.72	0.73	0.72	718	Actual: low	low	medium	high
F1 Score: 0.7734	medium	0.81	0.83	0.82	1178	medium	522	195	1
	high	0.67	0.33	0.44	54	high	197	973	8
	avg / total	0.77	0.78	0.77	1950		3	33	18

**Figure 9-26.** Model performance metrics for random forest for wine quality predictive model

The model prediction results on the test dataset depict an overall **F1 Score** and model **accuracy** of approximately 77%, as seen in Figure 9-26. This is definitely an improvement of 4% from what we obtained with just decision trees proving that ensemble learning is working better.

Another way to further improve on this result is model tuning. To be more specific, models have hyperparameters that can be tuned, as we have discussed previously in detail in the “Model Tuning and Hyperparameter Tuning” sections in Chapter 5. Hyperparameters are also known as meta-parameters and are usually set before we start the model training process. These hyperparameters do not have any dependency on being derived from the underlying data on which the model is trained. Usually these hyperparameters represent some high level concepts or *knobs*, which can be used to tweak and tune the model during training to improve its performance. Our random forest model has several hyperparameters and you can view its default values as follows.

```
In [25]: print(wqp_rf.get_params())
{'bootstrap': True, 'random_state': None, 'verbose': 0, 'min_samples_leaf': 1, 'min_weight_
fraction_leaf': 0.0, 'max_depth': None, 'class_weight': None, 'max_leaf_nodes': None,
'oob_score': False, 'criterion': 'gini', 'n_estimators': 10, 'max_features': 'auto', 'min_
impurity_split': 1e-07, 'n_jobs': 1, 'warm_start': False, 'min_samples_split': 2}
```

From the preceding output, you can see a number of hyperparameters. We recommend checking out the official documentation at <http://scikit-learn.org/stable/modules/generated/sklearn.ensemble.RandomForestClassifier.html> to learn more about each parameter. For hyperparameter tuning, we will keep things simple and focus our attention on `n_estimators` which represents the total number of base tree models in the forest ensemble model and `max_features` which represents the number of features to consider during each best split. We use a standard grid search method with five-fold cross validation to select the best hyperparameters.

```
In [26]: from sklearn.model_selection import GridSearchCV
...:
...: param_grid = {
...:     'n_estimators': [100, 200, 300, 500],
...:     'max_features': ['auto', None, 'log2']
...: }
...:
...: wqp_clf = GridSearchCV(RandomForestClassifier(random_state=42), param_grid, cv=5,
...:     scoring='accuracy')
...: wqp_clf.fit(wqp_train_SX, wqp_train_y)
...: print(wqp_clf.best_params_)
{'max_features': 'auto', 'n_estimators': 200}
```

We can see the chosen value of the hyperparameters obtained after the grid search in the preceding output. We have 200 estimators and auto maximum features which represents the square root of the total number of features to be considered during the best split operations. The scoring parameter was set to

accuracy to evaluate the model for best accuracy. You can set it to other parameters to evaluate the model on other metrics like F1 score, precision, recall and so on. Check out [http://scikit-learn.org/stable/modules/model\\_evaluation.html#scoring-parameter](http://scikit-learn.org/stable/modules/model_evaluation.html#scoring-parameter) for further details. You can view the grid search results for all the hyperparameter combinations as follows.

```
In [27]: results = wqp_clf.cv_results_
...: for param, score_mean, score_sd in zip(results['params'], results['mean_test_score'],
...:                                     results['std_test_score']):
...:     print(param, round(score_mean, 4), round(score_sd, 4))
{'max_features': 'auto', 'n_estimators': 100} 0.7928 0.0119
{'max_features': 'auto', 'n_estimators': 200} 0.7955 0.0101
{'max_features': 'auto', 'n_estimators': 300} 0.7941 0.0086
{'max_features': 'auto', 'n_estimators': 500} 0.795 0.0094
{'max_features': None, 'n_estimators': 100} 0.7847 0.0144
{'max_features': None, 'n_estimators': 200} 0.781 0.0149
{'max_features': None, 'n_estimators': 300} 0.784 0.0128
{'max_features': None, 'n_estimators': 500} 0.7858 0.0107
{'max_features': 'log2', 'n_estimators': 100} 0.7928 0.0119
{'max_features': 'log2', 'n_estimators': 200} 0.7955 0.0101
{'max_features': 'log2', 'n_estimators': 300} 0.7941 0.0086
{'max_features': 'log2', 'n_estimators': 500} 0.795 0.0094
```

The preceding output depicts the selected hyperparameter combinations and its corresponding mean accuracy and standard deviation values across the grid. Let's train a new random forest model with the tuned hyperparameters and evaluate its performance on the test data.

```
In [28]: wqp_rf = RandomForestClassifier(n_estimators=200, max_features='auto', random_state=42)
...: wqp_rf.fit(wqp_train_SX, wqp_train_y)
...:
...: wqp_rf_predictions = wqp_rf.predict(wqp_test_SX)
...: meu.display_model_performance_metrics(true_labels=wqp_test_y,
...:                                     predicted_labels=wqp_rf_predictions, classes=wqp_label_names)
```

Model Performance metrics:	Model Classification report:				Prediction Confusion Matrix:				
Accuracy: 0.8108									
Precision: 0.8114									
Recall: 0.8108									
F1 Score: 0.8053									
		precision	recall	f1-score	support	Actual: low	low	medium	high
	low	0.80	0.73	0.76	718	low	522	196	0
	medium	0.82	0.89	0.85	1178	medium	132	1044	2
	high	0.88	0.28	0.42	54	high	0	39	15
	avg / total	0.81	0.81	0.81	1950				

**Figure 9-27.** Model performance metrics for tuned random forest for wine quality predictive model

The model prediction results on the test dataset depict an overall **F1 Score** and model **accuracy** of approximately **81%**, as seen in Figure 9-27. This is quite good considering we got an improvement of **4%** from the initial random forest model before tuning and overall we got an improvement of **8%** from the base decision tree model. Also we can see that no low quality wine sample has been misclassified as high. Similarly no high quality wine sample has been misclassified as low. There is a considerable overlap between medium and high\low quality wine samples but that is expected given the nature of the data and class distribution.

Another way of modeling ensemble based methods is boosting. A very popular method is *XGBoost* which stands for Extreme Gradient Boosting. It is a variant of the Gradient Boosting Machines (GBM) model. This model is extremely popular in the Data Science community owing to its superior performance in several Data Science challenges and competitions especially on Kaggle. For using this model, you can install the `xgboost` package in Python. For details on this framework, feel free to check out the official web site at <http://xgboost.readthedocs.io/en/latest>, which offers detailed documentation on the installation, model tuning, and much more. Credits go to the Distributed Machine Learning Community, popularly known as DMLC for creating the XGBoost framework along with the popular MXNet Deep Learning framework. Gradient boosting using the principles of boosting methodology for ensembling, which we discussed earlier, and it uses gradient descent to minimize error or loss when adding new weak base learners. Going into details of the model internals would be out of the current scope, but we recommend checking out <http://xgboost.readthedocs.io/en/latest/model.html> for a nice introduction into boosted trees and the principle of XGBoost. We trained a basic XGBoost model first on our data and obtained an overall **accuracy** of around **74%**. After tuning the model with grid search, we trained the model with the following parameter values and evaluated its performance on the test data (detailed step-by-step snippets are available in the jupyter notebook).

```
In [29]: import os
...: mingw_path = r'C:\mingw-w64\mingw64\bin'
...: os.environ['PATH'] = mingw_path + ';' + os.environ['PATH']
...: import xgboost as xgb
...:
...: # train the model on tuned hyperparameters
...: wqp_xgb_model = xgb.XGBClassifier(seed=42, max_depth=10, learning_rate=0.3,
...:                                 n_estimators=100)
...: wqp_xgb_model.fit(wqp_train_SX, wqp_train_y)
...: # evaluate and predict performance
...: wqp_xgb_predictions = wqp_xgb_model.predict(wqp_test_SX)
...: meu.display_model_performance_metrics(true_labels=wqp_test_y,
...:                                       predicted_labels=wqp_xgb_predictions, classes=wqp_label_names)
```

Model Performance metrics:	Model Classification report:					Prediction Confusion Matrix:			
Accuracy: 0.7887									
Precision: 0.7891									
Recall: 0.7887									
F1 Score: 0.7841									
		precision	recall	f1-score	support				
	low	0.75	0.71	0.73	718	Actual: low	low	medium	high
	medium	0.81	0.86	0.83	1178	medium	511	207	0
	high	0.89	0.30	0.44	54	high	165	1011	2
	avg / total	0.79	0.79	0.78	1950		3	35	16

**Figure 9-28.** Model performance metrics for tuned XGBoost model for wine quality predictive model

The model prediction results on the test dataset depict an overall **F1 Score** and model **accuracy** of approximately **79%**, as seen in Figure 9-28. Though random forests perform slightly better, it definitely performs better than a basic model like a decision tree. Try adding more hyperparameters to tune the model and see if you can get a better model. If you do find one, feel free to send a pull request to our repository!

We have successfully built a decent wine quality classifier using several techniques and also seen the importance of model tuning and validation. Let’s take our best model and run some model interpretation tasks on it to try to understand it better. To start with, we can look at the feature importance ranks given to the various features in the dataset. The following snippet shows comparative feature importance plots using `skater` as well as the default feature importances obtained from the `scikit-learn` model itself. We build an `Interpretation` and `InMemoryModel` object using `skater`, which will be useful for our future analyses in model interpretation.



```
In [31]: from skater.core.explanations import Interpretation
...: from skater.model import InMemoryModel
...: # leveraging skater for feature importances
...: interpreter = Interpretation(wqp_test_SX, feature_names=wqp_feature_names)
...: wqp_im_model = InMemoryModel(wqp_rf.predict_proba, examples=wqp_train_SX,
...:                             target_names=wqp_rf.classes_)
...: # retrieving feature importances from the scikit-learn estimator
...: wqp_rf_feature_importances = wqp_rf.feature_importances_
...: wqp_rf_feature_names, wqp_rf_feature_scores = zip(*sorted(zip(wqp_feature_names,
...:                                                             wqp_rf_feature_importances), key=lambda x: x[1]))
...: # plot the feature importance plots
...: f, (ax1, ax2) = plt.subplots(1, 2, figsize=(10, 3))
...: t = f.suptitle('Feature Importances for Random Forest', fontsize=12)
...: f.subplots_adjust(top=0.85, wspace=0.6)
...: y_position = list(range(len(wqp_rf_feature_names)))
...: ax1.barh(y_position, wqp_rf_feature_scores, height=0.6, align='center',
...:         tick_label=wqp_rf_feature_names)
...: ax1.set_title("Scikit-Learn")
...: ax1.set_xlabel('Relative Importance Score')
...: ax1.set_ylabel('Feature')
...: plots = interpreter.feature_importance.plot_feature_importance(wqp_im_model,
...:                                                                ascending=False, ax=ax2)
...: ax2.set_title("Skater")
...: ax2.set_xlabel('Relative Importance Score')
...: ax2.set_ylabel('Feature')
```

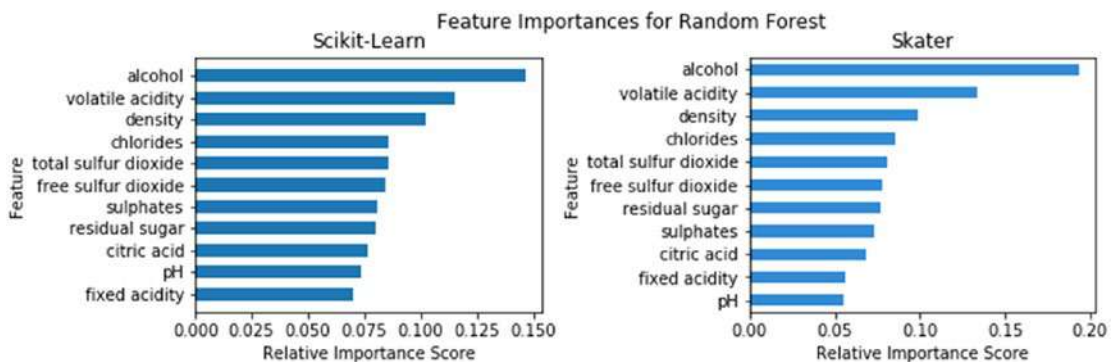
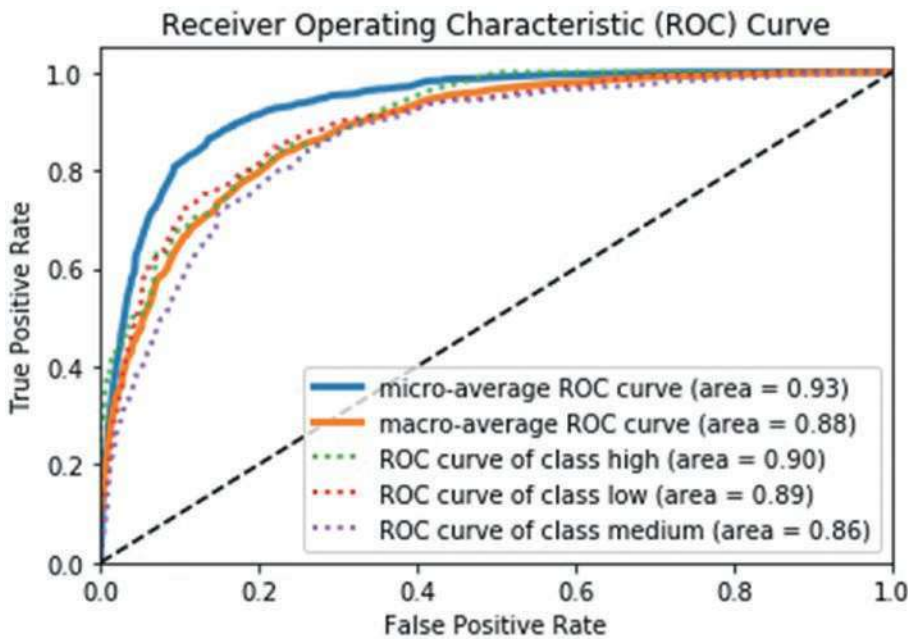

**Figure 9-29.** Comparative feature importance analysis obtained from our tuned random forest model

We can clearly observe from Figure 9-29 that the most important features are consistent across the two plots, which is expected considering we are just using different interfaces on the same model. The top two features are alcohol by volume and the volatile acidity content. We will be using them shortly for further analysis. But right now, let's look at the model's ROC curve and the area under curve (AUC) statistics. Plotting a binary classifier's ROC curve is easy, but what do you do when you are dealing with a multi-class classifier (3-class in our case)? There are several ways to do this. You would need to binarize the output. Once this operation is executed, you can plot one ROC curve per class label. Besides this, you can also follow two aggregation metrics for computing the average ROC measures. *Micro-averaging* involves plotting an ROC curve over the entire prediction space by considering each predicted element as a binary

prediction. Hence equal weight is given to each prediction classification decision. *Macro-averaging* involves giving equal weight to each class label when averaging. Our `model_evaluation_utils` module has a nifty customizable function `plot_model_roc_curve(...)`, which can help plot multi-class classifier ROC curves with both micro- and macro-averaging capabilities. We recommend you to check out the code, which is pretty self-explanatory. Let's now plot the ROC curve for our random forest classifier.

```
In [32]: meu.plot_model_roc_curve(wqp_rf, wqp_test_SX, wqp_test_y)
```



**Figure 9-30.** ROC curve for our tuned random forest model

You can see the various ROC plots (per-class and averaged) in Figure 9-30 for our tuned random forest model. The AUC is pretty good based on what we see. The dotted lines indicate the per-class ROC curves and the lines in bold are the macro and micro-average ROC curves. Let's now revisit our top two most important features—alcohol and volatile acidity. Let's use them and try to plot the decision surface\boundary of our random forest model, similar to what we had done earlier for our logistic regression based wine type classifier in Figure 9-22.

```
In [33]: feature_indices = [i for i, feature in enumerate(wqp_feature_names)
...:                        if feature in ['alcohol', 'volatile acidity']]
...: meu.plot_model_decision_surface(clf=wqp_rf,
...:                                 train_features=wqp_train_SX[:, feature_indices],
...:                                 train_labels=wqp_train_y, plot_step=0.02, cmap=plt.cm.RdYlBu,
...:                                 markers=['.', 'd', '+'], alphas=[1.0, 0.8, 0.5],
...:                                 colors=['r', 'b', 'y'])
```

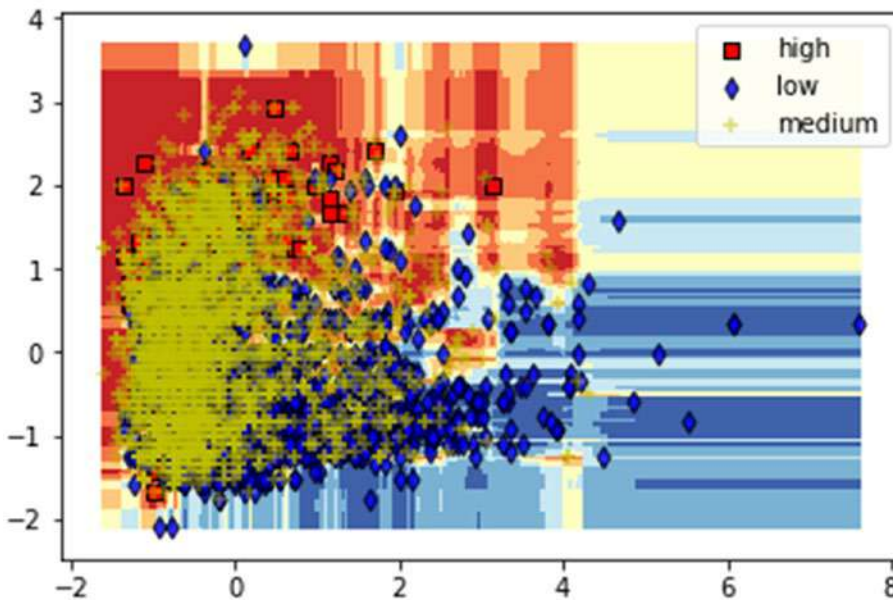

**Figure 9-31.** Visualizing the model decision surface for our tuned random forest model

The plot depicted in Figure 9-31 shows us that the three classes are definitely not as easily distinguishable as our wine type classifier for red and white wine. Of course, visualizing the hypersurfaces with multiple features becomes difficult as compared to visualizing with the two most important features, but the plot should give you a good idea that the model is able to distinguish well between the classes, although there is a certain amount of overlap, especially with the wine samples of medium quality rating with high and low quality rated wine samples.

Let's look at some model prediction interpretations similar to what we did in Chapter 7, where we analyzed movie review sentiments. For this, we will be leveraging `skater` and look at model predictions. We will try to interpret why the model predicted a class label and which features were influential in its decision. First we build a `LimeTabularExplainer` object using the following snippet, which will help us in interpreting and explaining predictions.

```
from skater.core.local_interpretation.lime.lime_tabular import LimeTabularExplainer

exp = LimeTabularExplainer(wqp_train_SX, feature_names=wqp_feature_names,
                           discretize_continuous=True,
                           class_names=wqp_rf.classes_)
```

Let's now look at two wine sample instances from our test dataset. The first instance is a wine of low quality rating. We show the interpretation for the predicted class with maximum probability\confidence using the `top_labels` parameter. You can set it to 3 to view the same for all the three class labels.

```
exp.explain_instance(wqp_test_SX[10], wqp_rf.predict_proba, top_labels=1).show_in_notebook()
```

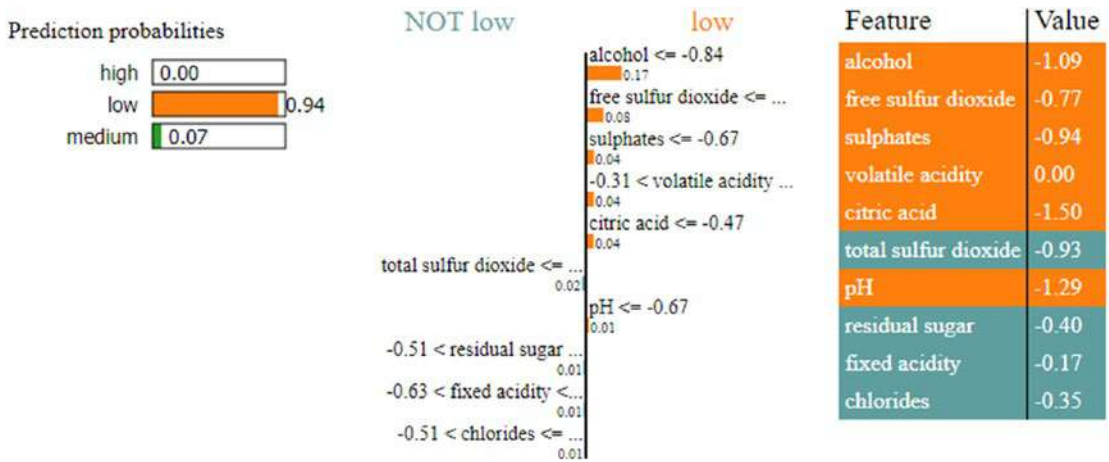

**Figure 9-32.** Model interpretation for our wine quality model's prediction for a low quality wine

The results depicted in Figure 9-32 show us the features that were primarily responsible for the model to predict the wine quality as low. We can see that the most important feature was alcohol, which makes sense considering what we obtained in our analyses so far from feature importances and model decision surface interpretations. The values for each corresponding feature depicted here are the scaled values obtained after feature scaling. Let's interpret another prediction, this time for a wine of high quality.

```
exp.explain_instance(wqp_test_SX[747], wqp_rf.predict_proba, top_labels=1).show_in_notebook()
```

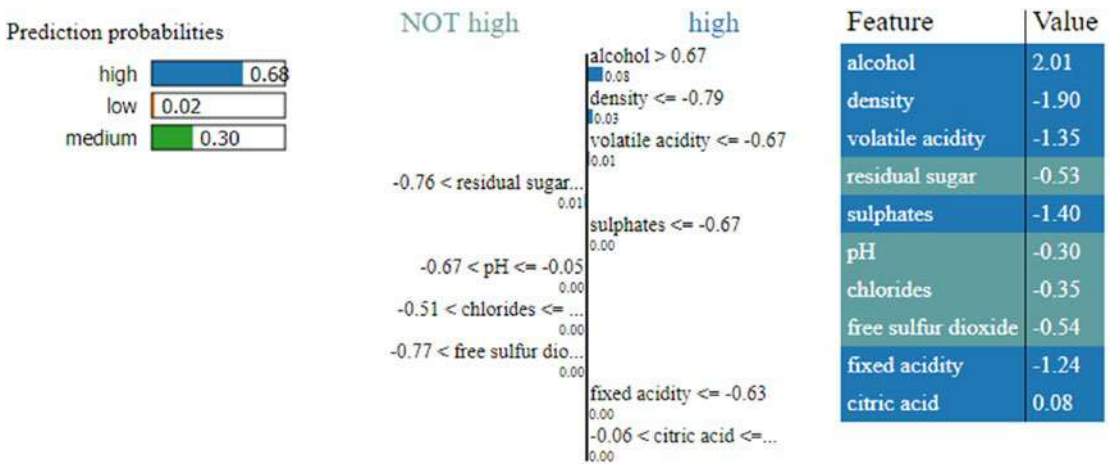
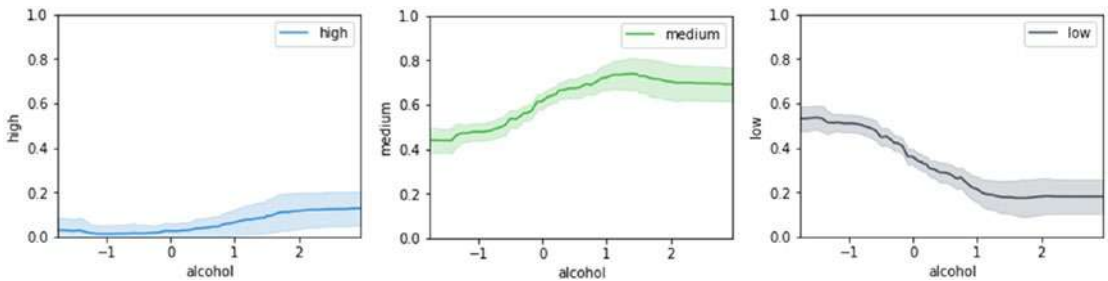

**Figure 9-33.** Model interpretation for our wine quality model's prediction for a high quality wine

From the interpretation in Figure 9-33, we can see the features responsible for the model correctly predicting the wine quality as high and the primary feature was again alcohol by volume (besides other features like density, volatile acidity, and so on). Also you can notice a stark difference in the scaled values of alcohol for the two instances depicted in Figure 9-32 and Figure 9-33.

To wrap up our discussion on model interpretation, we will be talking about partial dependence plots and how they are useful in our scenario. In general, partial dependence helps describe the marginal impact or influence of a feature on the model prediction decision by holding the other features constant. Because it is very difficult to visualize high dimensional feature spaces, typically one or two influential and important features are used to visualize partial dependence plots. The scikit-learn framework has functions like `partial_dependence(...)` and `plot_partial_dependence(...)`, but unfortunately as of the time of writing this book, these functions only work on boosting models like GBM. The beauty of skater is that we can build partial dependence plots on any model including our tuned random forest model. We will leverage skater's Interpretation object, `interpreter`, and the `InMemoryModel` object, `wqp_im_model`, based on our random forest model that we had created earlier when we computed the feature importances. The following code depicts one-way partial dependence plots for our model prediction function based on the most important feature, alcohol.

```
In [36]: axes_list = interpreter.partial_dependence.plot_partial_dependence(['alcohol'],
...:                               wqp_im_model, grid_resolution=100, with_variance=True, figsize = (4, 3))
...: axes = axes_list[0][3:]
...: [ax.set_ylim(0, 1) for ax in axes];
```



**Figure 9-34.** One-way partial dependence plots for our random forest model predictor based on alcohol

From the plots in Figure 9-34, we can see that with an increase in the quantity of alcohol content, the confidence/probability of the model predictor increases in predicting the wine to be either medium or high and similarly it decreases for the probability of wine to be of low quality. This shows there is definitely some relationship between the class predictions with the alcohol content and again the influence of alcohol for predictions of class high is pretty low, which is expected considering training samples for high quality wine are less. Let's now plot two-way partial dependence plots for interpreting our random forest predictor's dependence on alcohol and volatile acidity, the top two influential features.

```
In [42]: plots_list = interpreter.partial_dependence.plot_partial_dependence([('alcohol',
...:                               'volatile acidity')],
...:                               wqp_im_model, n_samples=1000, figsize=(10, 5), grid_resolution=100)
...: axes = plots_list[0][3:]
...: [ax.set_zlim(0, 1) for ax in axes];
```

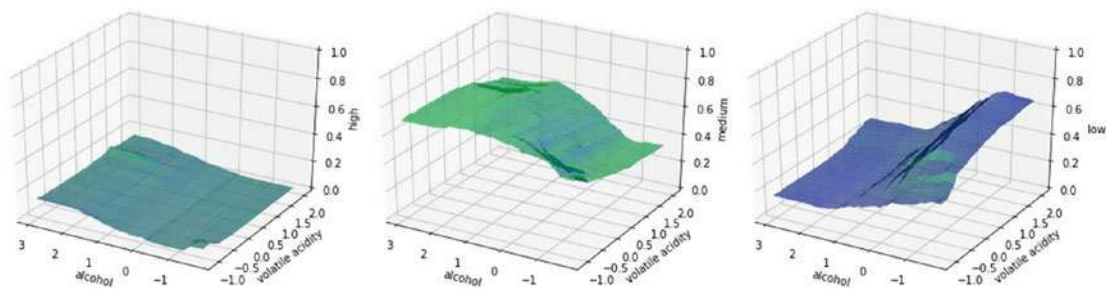

**Figure 9-35.** Two-way partial dependence plots for our random forest model predictor based on alcohol and volatile acidity

The plots in Figure 9-35 bear some resemblance with the plots in Figure 9-34. For predicting high quality wine, due to the lack of training data, while some dependency is there for high wine quality class prediction with the increase in alcohol and corresponding decrease in volatile acidity it is quite weak, as we can see in the left most plot. There also seems to be a strong dependency on low wine quality class prediction with the corresponding decrease in alcohol and the increase in volatile acidity levels. This is clearly visible in the rightmost plot. The plot in the middle talks about medium wine quality class predictions. We can observe predictions having a strong dependency with corresponding increase in alcohol and with decrease in volatile acidity levels. This should give you a good foundation on leveraging partial dependence plots to dive deeper into model interpretation.

## Summary

In this case study oriented chapter, we processed, analyzed, and modeled on a dataset pertaining to wine samples with a focus on type and quality ratings. Special emphasis was on exploratory data analysis, which is often overlooked by data scientists in a hurry to build and deploy models. Some background in the domain was explored with regard to various features in our wine dataset, which were explained in detail. We recommend always exploring the domain in which you are solving problems and taking the help of subject matter experts whenever needed, besides focusing on math, Machine Learning, and analysis.

We looked at multiple ways to analyze and visualize our data and its features, including descriptive and inferential statistics and univariate and multivariate analysis. Special techniques for visualizing categorical and multi-dimensional data were explained in detail. The intent is for you to build on these principles and re-use similar principles and code to visualize attributes and relationships on your own datasets in the future. Two main objectives of this chapter were to build predictive models for predicting wine types and quality based on various physicochemical wine attributes. We covered a variety of predictive models, including linear models like logistic regression and complex models including deep neural networks. Besides this, we also covered tree based models like decision trees and ensemble models like random forests and the very popular extreme gradient boosting model. Various aspects of model training, prediction, evaluation, tuning, and interpretation were covered in detail. We recommend you to not only build models but evaluate them thoroughly with validation metrics, use hyperparameter tuning where necessary, and leverage ensemble modeling to build robust, generalized, and superior models. Special focus has also been given to concepts and techniques for interpreting models, including analyzing feature importances, visualizing model ROC curves and decision surfaces, explaining model predictions, and visualizing partial dependence plots.



# Analyzing Music Trends and Recommendations

Recommendation engines are probably one of the most popular and well known Machine Learning applications. A lot of people who don't belong to the Machine Learning community often assume that recommendation engines are its only use. Although we know that Machine Learning has a vast subspace where recommendation engines are just one of the candidates, there is no denying the popularity of recommendation engines. One of the reasons for their popularity is their ubiquitous nature; anyone who is online, in any way, has been in touch with a recommendation engine in some form or the other. They are used for recommending products on ecommerce sites, travel destinations on travel portal, songs/videos on streaming sites, restaurants on food aggregator portals, etc. A long list underlines their universal application.

The popularity of recommendation engines stems from two very important points about them:

- *They are easy to implement:* Recommendation engines are easy to integrate in an already existing workflow. All we need is to collect some data regarding our user trends and patterns, which normally can be extracted from the business' transactional database.
- *They work:* This statement is equally true for all the other Machine Learning solutions that we have discussed. But an important distinction comes from the fact that they have a very limited downside. For example, consider a travel portal, which suggests a set of most popular locations from its dataset. The recommendation system can be a trivial one but its mere presence in front of the user is likely to generate user interest. The firm can definitely gain by working a sophisticated recommendation engine but even a very simple one is guaranteed to pay some dividends with minimal investments. This point makes them a very attractive proposition.

This chapter studies how we can use transactional data to develop different types of recommendation engines. We will learn about an auxiliary dataset of a very interesting dataset, "The million song dataset". We will go through user listening history and then use it to develop multiple recommendation engines with varying levels of sophistication.

## The Million Song Dataset Taste Profile

The million song dataset is a very popular dataset and is available at <https://labrosa.ee.columbia.edu/millionsong/>. The original dataset contained quantified audio features of around a million songs ranging over multiple years. The dataset was created as a collaborative project between The Echonest (<http://the.echonest.com/>) and LABRosa (<http://labrosa.ee.columbia.edu/>). Although we will not be using this dataset directly, we will be using some parts of it.

Several other datasets were spawned from the original million song dataset. One of those datasets was called The Echonest Taste Profile Subset. This particular dataset was created by The Echonest with some undisclosed partners. The dataset contains play counts by anonymous users for songs contained in the million songs dataset. The taste profile dataset is quite big, as it contains around 48 million lines of triplets. The triplets contain the following information:

*(user id, song id, play counts)*

Each row gives the play counts of a song identified by the song ID for the user identified by the user ID. The overall dataset contains around a million unique users and around 384,000 songs from the million song dataset are contained in it.

The readers can download the dataset from [http://labrosa.ee.columbia.edu/millionsong/sites/default/files/challenge/train\\_triplets.txt.zip](http://labrosa.ee.columbia.edu/millionsong/sites/default/files/challenge/train_triplets.txt.zip). The size of the compressed dataset is around 500MB and, upon decompression, you need a space of around 3.5GB. Once you have the data downloaded and uncompressed, you will see how to subset the dataset to reduce its size.

---

■ The million song dataset has several other useful auxiliary datasets. We will not be covering them in detail here, but we encourage the reader to explore these datasets and use their imagination for developing innovative use cases.

---

## Exploratory Data Analysis

Exploratory data analysis is an important part of any data analysis workflow. By this time, we have established this fact firmly in the mindset of our readers. The exploratory data analysis becomes even more important in the cases of large datasets, as this will often lead us to information that we can use to trim down the dataset a little. As we will see, sometimes we will also go beyond the traditional data access tools to bypass the problems posed by the large size of data.

### Loading and Trimming Data

The first step in the process is loading the data from the uncompressed files. As the data size is around 3GB, we will not load the complete data but we will only load a specified number of rows from the dataset. This can be achieved by using the `nrows` parameter of the `read_csv` function provided by pandas.

```
In [2]: triplet_dataset = pd.read_csv(filepath_or_buffer=data_home+'train_triplets.txt',
...: nrows=10000, sep='\t', header=None, names=['user', 'song', 'play_count'])
```



Since the dataset doesn't have a header, we also provided the column name to the function. A subset of the data is shown in Figure 10-1.

	user	song	play_count
0	b80344d063b5ccb3212f76538f3d9e43d87dca9e	SOAKIMP12A8C130995	1
1	b80344d063b5ccb3212f76538f3d9e43d87dca9e	SOAPDEY12A81C210A9	1
2	b80344d063b5ccb3212f76538f3d9e43d87dca9e	SOBBMDR12A8C13253B	2
3	b80344d063b5ccb3212f76538f3d9e43d87dca9e	SOBFNSP12AF72A0E22	1
4	b80344d063b5ccb3212f76538f3d9e43d87dca9e	SOBFOVM12A58A7D494	1
5	b80344d063b5ccb3212f76538f3d9e43d87dca9e	SOBNZDC12A8D4FC103	1
6	b80344d063b5ccb3212f76538f3d9e43d87dca9e	SOBSUJE12A8D4F8CF5	2
7	b80344d063b5ccb3212f76538f3d9e43d87dca9e	SOBVFZR12A8D4F8AE3	1
8	b80344d063b5ccb3212f76538f3d9e43d87dca9e	SOBXALG12A8C13C108	1
9	b80344d063b5ccb3212f76538f3d9e43d87dca9e	SOBXHDL12A81C204C0	1

**Figure 10-1.** Sample rows from *The Echonest taste profile dataset*

The first thing we may want to do in the dataset of this size is determine how many unique users (or songs) we should consider. In the original dataset, we have around a million users, but we want to determine the number of users we should consider. For example, if 20% of all the users account for around 80% of total play counts, then it would be a good idea to focus our analysis on those 20% users. Usually this can be done by summarizing the dataset by users (or by songs) and getting a cumulative sum of the play counts. Then we can find out how many users account for 80% of the play counts, etc. But due to the size of the data, the cumulative summation function provided by pandas will run into trouble. So we will write code to read the file line by line and extract the play count information on a user (or song). This will also serve as a possible method that readers can use in case the dataset size exceeds the memory available on their systems. The code snippet that follows will read the file line by line, extract total play count of all the users, and persist that information for later use.

```
In [2]: output_dict = {}
...: with open(data_home+'train_triplets.txt') as f:
...: for line_number, line in enumerate(f):
...:     user = line.split('\t')[0]
...:     play_count = int(line.split('\t')[2])
...:     if user in output_dict:
...:         play_count += output_dict[user]
...:         output_dict.update({user:play_count})
...:     output_dict.update({user:play_count})
...: output_list = [{ 'user':k, 'play_count':v} for k,v in output_dict.items()]
...: play_count_df = pd.DataFrame(output_list)
...: play_count_df = play_count_df.sort_values(by = 'play_count', ascending = False)
...: play_count_df.to_csv(path_or_buf='user_playcount_df.csv', index = False)
```

The persisted dataframe can be then loaded and used based on our requirements. We can use a similar strategy to extract play counts for each of the songs. A few lines from the dataset are shown in Figure 10-2

	play_count	user
0	13132	093cb74eb3c517c5179ae24caf0ebec51b24d2a2
1	9884	119b7c88d58d0c8eb051365c103da5caf817bea6
2	8210	3fa44853315897f42410a30cb766a4eb102080bb
3	7015	a2679496cd0af9779a92a13ff7c6af5c81ea8c7b
4	6494	d7d2d888ae04d16e994d6964214a1de81392ee04
5	6472	4ae01afa8f2430ea0704d502bc7b57fb52164882
6	6150	b7c24f770be6b802805ac0e2106624a517643c17
7	5656	113255a012b2affeab62607563d03bfd31b08e7
8	5620	6d625c8557df84b60d90426c0116138b617b9449
9	5602	99ac3d883681e21ea68071019dba828ce76fe94d

**Figure 10-2.** Play counts for some users

The first thing we want to find out about our dataset is the number of users that we will need to account for around 40% of the play counts. We have arbitrarily chosen a value of 40% to keep the dataset size manageable; you can experiment with these figures to get different sized datasets and even leverage big data processing and analysis frameworks like Spark on top of Hadoop to analyze the complete dataset! The following code snippet will determine the subset of users that account for this percentage of data. In our case around 10,000 users account for 40% of play counts, hence we will subset those users.

```
In [2]: total_play_count = sum(song_count_df.play_count)
...: (float(play_count_df.head(n=100000).play_count.sum())/total_play_count)*100
...: play_count_subset = play_count_df.head(n=100000)
```

In similar way, we can determine the number of unique songs required to explain 80% of the total play count. In our case, we will find that 30,000 songs account for around 80% of the play count. This information is already a great find, as around 10% of the songs are contributing to 80% of the play count. Using a code snippet similar to one given previously, we can determine the subset of such songs. With these songs and user subsets, we can subset our original dataset to reduce the dataset to contain only filtered users and songs. The code snippet that follows uses these dataframes to filter the original dataset and then persists the resultant dataset for future uses.

```
In [2]: triplet_dataset =
...: pd.read_csv(filepath_or_buffer=data_home+'train_triplets.txt', sep='\t', header=None,
...: names=['user', 'song', 'play_count'])
...: triplet_dataset_sub = triplet_dataset[triplet_dataset.user.isin(user_subset) ]
```

```

...: del(triplet_dataset)
...: triplet_dataset_sub_song =
...: triplet_dataset_sub[triplet_dataset_sub.song.isin(song_subset)]
...: del(triplet_dataset_sub)
...: triplet_dataset_sub_song.to_csv(path_or_buf=data_home+'triplet_dataset_sub_song.
      csv', index = False)

```

This subsetting will give us a dataframe with around 10 million rows of tuples. We will use this as the starting dataset for our all future analyses. You can play around with these numbers to arrive at different datasets and possibly different results.

## Enhancing the Data

The data we loaded is just the triplet data so we are not able to see the song name, the artist name, or the album names. We can enhance our data by adding this information about the songs. This information is part of the million song database. This data is provided as a SQLite database file. First we will download the data by downloading the `track_metadata.db` file from the web page at <https://labrosa.ee.columbia.edu/millionsong/pages/getting-dataset#subset>.

The next step is to read this SQLite database to a dataframe and extract track information by merging it with our triplet dataframe. We will also drop some extra columns that we won't be using for our analysis. The code snippet that follows will load the entire dataset, join it with our subsetting triplet data, and drop the extra columns.

```

In [2]: conn = sqlite3.connect(data_home+'track_metadata.db')
...: cur = conn.cursor()
...: cur.execute("SELECT name FROM sqlite_master WHERE type='table'")
...: cur.fetchall()

```

```
Out[2]: [('songs',)]
```

The output of the above snippet shows that the database contains a table named `songs`. We will get all the rows from this table and read it into a dataframe.

```

In [5]: del(track_metadata_df_sub['track_id'])
...: del(track_metadata_df_sub['artist_mbid'])
...: track_metadata_df_sub = track_metadata_df_sub.drop_duplicates(['song_id'])
...: triplet_dataset_sub_song_merged = pd.merge(triplet_dataset_sub_song, track_metadata_
      df_sub, how='left', left_on='song', right_o
...: n='song_id')
...: triplet_dataset_sub_song_merged.rename(columns={'play_count':'listen_
      count'},inplace=True)
...: del(triplet_dataset_sub_song_merged['song_id'])
...: del(triplet_dataset_sub_song_merged['artist_id'])
...: del(triplet_dataset_sub_song_merged['duration'])
...: del(triplet_dataset_sub_song_merged['artist_familiarity'])
...: del(triplet_dataset_sub_song_merged['artist_hottnesss'])
...: del(triplet_dataset_sub_song_merged['track_7digitalid'])
...: del(triplet_dataset_sub_song_merged['shs_perf'])
...: del(triplet_dataset_sub_song_merged['shs_work'])

```

The final dataset, merged with the triplets dataframe looks similar to the depiction in Figure 10-3. This will form the starting dataframe for our exploratory data analysis.

	user	song	listen_count	title	release	artist_name	year
0	d6589314c0a9bcbca4fee0c93b14bc402363afea	SOADQPP12A67020C82	12	You And Me Jesus	Tribute To Jake Hess	Jake Hess	2004
1	d6589314c0a9bcbca4fee0c93b14bc402363afea	SOAFTRR12AF72A8D4D	1	Harder Better Faster Stronger	Discovery	Daft Punk	2007
2	d6589314c0a9bcbca4fee0c93b14bc402363afea	SOANQFY12AB0183239	1	Uprising	Uprising	Muse	0
3	d6589314c0a9bcbca4fee0c93b14bc402363afea	SOAYATB12A6701FD50	1	Breakfast At Tiffany's	Home	Deep Blue Something	1993
4	d6589314c0a9bcbca4fee0c93b14bc402363afea	SOBOAFP12A8C131F36	7	Lucky (Album Version)	We Sing. We Dance. We Steal Things.	Jason Mraz & Colbie Caillat	0
5	d6589314c0a9bcbca4fee0c93b14bc402363afea	SOBONKR12A58A7A7E0	26	You're The One	If There Was A Way	Dwight Yoakam	1990
6	d6589314c0a9bcbca4fee0c93b14bc402363afea	SOBZZDU12A6310D8A3	7	Don't Dream It's Over	Recurring Dream... Best Of Crowded House (Domest...	Crowded House	1986
7	d6589314c0a9bcbca4fee0c93b14bc402363afea	SOCART12A8C13A1A4	5	S.O.S.	SOS	Jonas Brothers	2007
8	d6589314c0a9bcbca4fee0c93b14bc402363afea	SODASIJ12A6D4F5D89	1	The Invisible Man	The Invisible Man	Michael Cretu	1985
9	d6589314c0a9bcbca4fee0c93b14bc402363afea	SODEAWL12AB0187032	8	American Idiot (feat. Green Day & The Cast Of ...	The Original Broadway Cast Recording 'American...	Green Day	0

Figure 10-3. Play counts dataset merged with songs metadata

## Visual Analysis

Before we start developing various recommendation engines, let's do some visual analysis of our dataset. We will try to see what the different trends are regarding the songs, albums, and releases.

### Most Popular Songs

The first information that we can plot for our data concerns the popularity of the different songs in the dataset. We will try to determine the top 20 songs in our dataset. A slight modification of this popularity will also serve as our most basic recommendation engine.

The following code snippet gives us the most popular songs from our dataset.

```
In [7]: import matplotlib.pyplot as plt; plt.rcdefaults()
...: import numpy as np
...: import matplotlib.pyplot as plt
...:
...: popular_songs = triplet_dataset_sub_song_merged[['title', 'listen_count']].
...:   groupby('title').sum().reset_index()
...: popular_songs_top_20 = popular_songs.sort_values('listen_count', ascending=False).
...:   head(n=20)
...: objects = (list(popular_songs_top_20['title']))
...: y_pos = np.arange(len(objects))
...: performance = list(popular_songs_top_20['listen_count'])
...:
...: plt.bar(y_pos, performance, align='center', alpha=0.5)
...: plt.xticks(y_pos, objects, rotation='vertical')
...: plt.ylabel('Item count')
...: plt.title('Most popular songs')
...: plt.show()
```

The plot that's generated by the code snippet is shown in Figure 10-4. The plot shows that the most popular song of our dataset is “You're the One”. We can also search through our track dataframe to see that the band responsible for that particular track is The Black Keys.

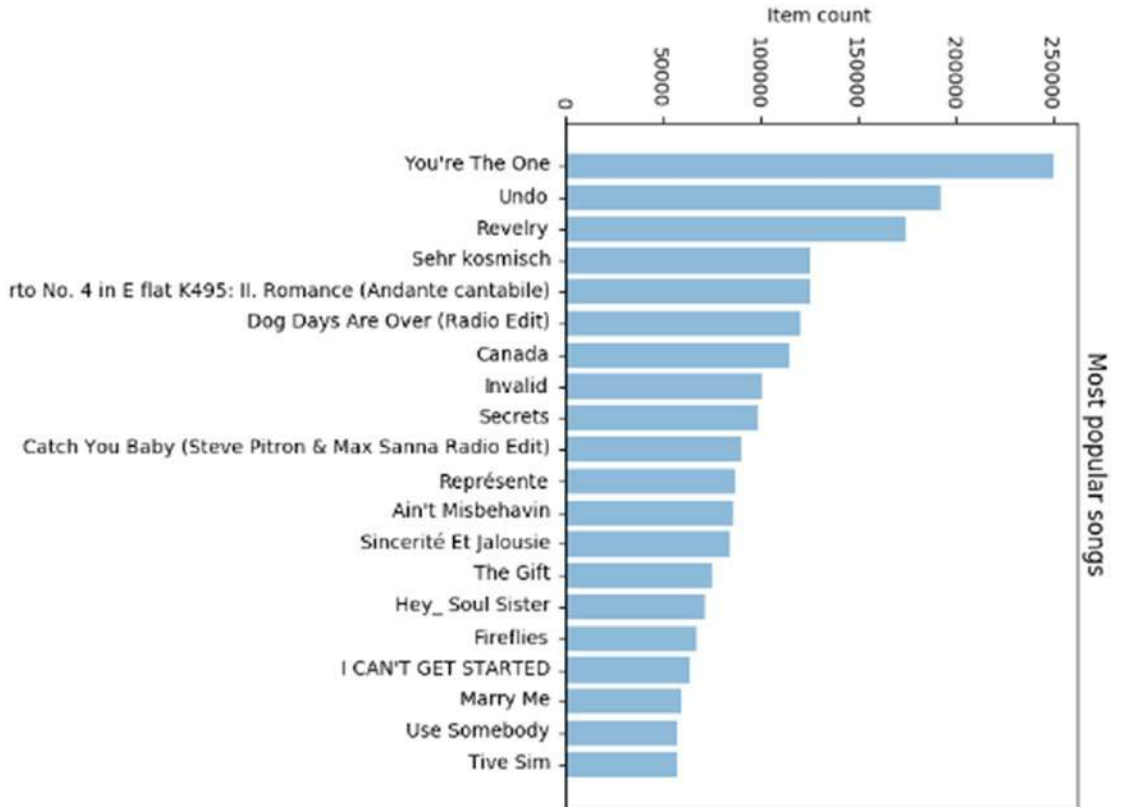

*Figure 10-4. Most popular songs*

## Most Popular Artist

The next information the readers may be interested in is, who are the most popular artists in the dataset? The code to plot this information is quite similar to the code given previously, so we will not include the exact code snippet. The resultant graph is shown in Figure 10-5.

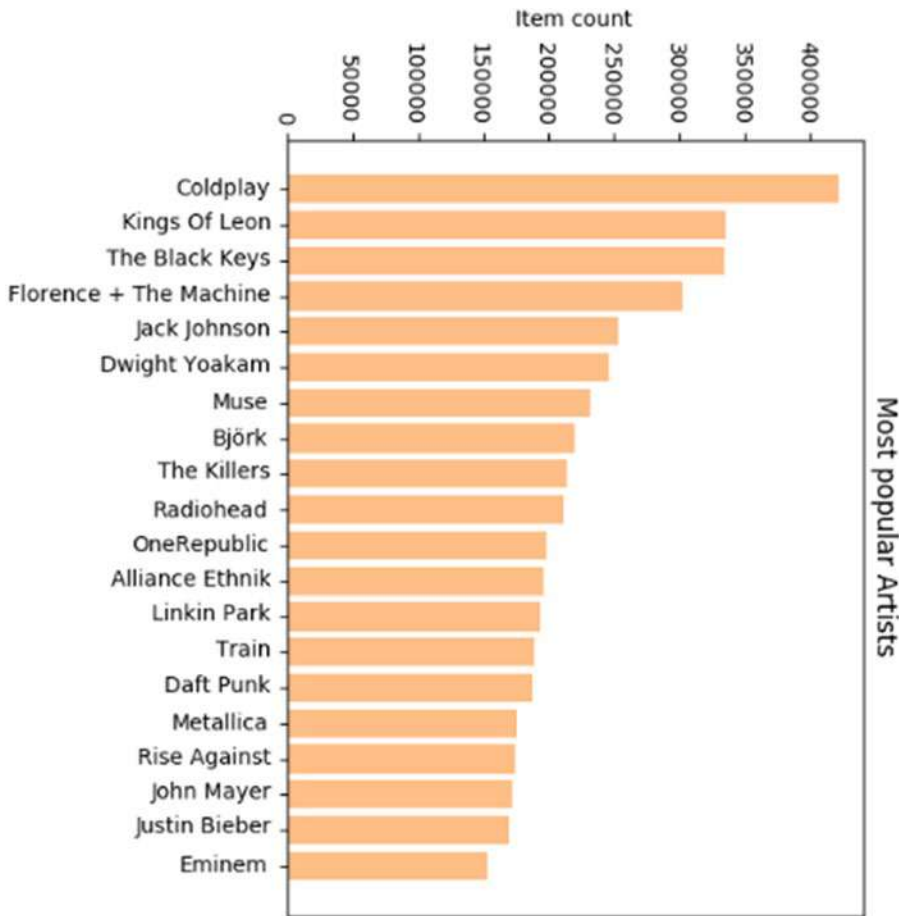

**Figure 10-5.** Most popular artists

We can read the plot to see that Coldplay is one of the most popular artists according to our dataset. A keen music enthusiast can see that we don't have a lot of representation from the classic artists like U2 or The Beatles, except for maybe Metallica and Radiohead. This underlines two key points—first, the data is mostly sourced from the generation that's not just always listening to the classic artists online and second, that very rarely we have an artist that's not of the present generation but still scores high when it comes to online plays. Surprisingly the only example of such behavior in our dataset is Metallica and Radiohead. They have their origins in the 1980s but are still pretty popular when it comes to online play counts. Diverse music genre representations are depicted however in the top artists with popular rap artists like Eminem, alternative rock bands like Linkin Park and The Killers and even pop/rock bands like Train and OneRepublic, besides classic rock or metal bands like Radiohead and Metallica!

Another slightly off reading is that Coldplay is the most popular artist, but they don't have a candidate in the most popular songs list. This indirectly hints at an even distribution of those play counts across all of their tracks. You can take it as exercise to determine song play distribution for each of the artists who appear in the plot in Figure 10-5. This will give you a clue as to whether the artist holds a skewed or uniform popularity. This idea can be further developed to a full-blown recommendation engine.

## User vs. Songs Distribution

The last information that we can seek from our dataset is regarding the distribution of song count for users. This information will tell us how the number of songs that users listen to on average are distributed. We can use this information to create different categories of users and modify the recommendation engine on that basis. The users who are listening to a very select number of songs can be used for developing simple recommendation engines and the users who provide us lots of insight into their behavior can be candidates for developing complex recommendation engines.

Before we go on to plot that distribution, let's try to find some statistical information about that distribution. The following code calculates that distribution and then shows summary statistics about it.

```
In [11]: user_song_count_distribution = triplet_dataset_sub_song_merged[['user', 'title']].
groupby('user').count().reset_index().sort_values(by='title', ascending = False)
...: user_song_count_distribution.title.describe()
Out[11]:
count    99996.000000
mean      107.752160
std        79.741555
min         1.000000
25%        53.000000
50%        89.000000
75%       141.000000
max       1189.000000
Name: title, dtype: float64
```

This gives us some important information about how the song counts are distributed across the users. We see that on an average, a user will listen to 100+ songs, but some users have a more voracious appetite for song diversification. Let's try to visualize this particular distribution. The code that follows will help us plot the distribution of play counts across our dataset. We have intentionally kept the number of bins to a small amount, as that can give approximate information about the number of classes of users we have.

```
In [12]: x = user_song_count_distribution.title
...: n, bins, patches = plt.hist(x, 50, facecolor='green', alpha=0.75)
...: plt.xlabel('Play Counts')
...: plt.ylabel('Probability')
...: plt.title(r'$\mathrm{Histogram\ of\ User\ Play\ Count\ Distribution}$')
...: plt.grid(True)
...: plt.show()
```

The distribution plot generated by the code is shown in Figure 10-6. The image clearly shows that, although we have a huge variance in the minimum and maximum play count, the bulk of the mass of the distribution is centered on 100+ song counts.

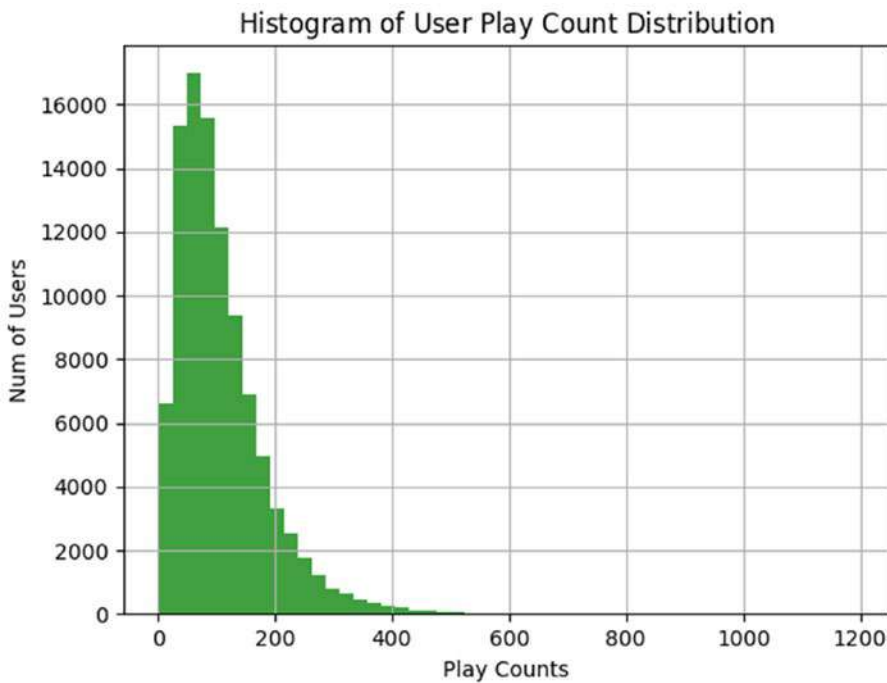

**Figure 10-6.** *Distribution of play counts for users*

Given the nature of the data, we can perform a large variety of cool visualizations; for example, plotting how the top tracks of artists are played, the play count distribution on a yearly basis, etc. But we believe by now you are sufficiently skilled in both the art of asking pertinent questions and answering them through visualizations. So we will conclude our exploratory data analysis and move on to the major focus of the chapter, which is development of recommendation engines. But feel free to try out additional analysis and visualizations on this data and if you find out something cool, as always, feel free to send across a pull request to the book’s code repository!

## Recommendation Engines

The work of a recommendation engine is succinctly captured in its name—all it needs to do is make recommendations. But we must admit that this description is deceptively simple. Recommendation engines are a way of modeling and rearranging information available about user preferences and then using this information to provide informed recommendations on the basis of that information. The basis of the recommendation engine is always the recorded interaction between the users and products. For example, a movie recommendation engine will be based on the ratings provided to different movies by the users; a news article recommender will take into account the articles the user has read in past; etc.

This section uses the user-song play count dataset to uncover different ways in which we can recommend new tracks to different users. We will start with a very basic system and try to evolve linearly into a sophisticated recommendation system. Before we go into building those systems, we will examine their utility and the various types of recommendation engines.



## Types of Recommendation Engines

The major area of distinction in different recommendation engines comes from the entity that they assume is the most important in the process of generating recommendations. There are different options for choosing the central entity and that choice will determine the type of recommendation engine we will develop.

- **User-based recommendation engines:** In these types of recommendation engines, the user is the central entity. The algorithm will look for similarities among users and on the basis of those similarities will come up with the recommendation.
- **Content-based recommendation engines:** On the other end of the recommendation engine spectrum, we have the content-based recommendation engine. In these, the central entity is the content that we are trying to recommend; for example, in our case the entity will be songs we are trying to recommend. These algorithms will attempt to find features about the content and find similar content. Then these similarities will be used to make recommendations to the end users.
- **Hybrid-recommendation engines:** These types of recommendation engines will take into account both the features of the users and the content to develop recommendations. These are also sometimes termed as collaborative filtering recommendation engines as they “collaborate” by using the similarities of content as well as users. These are one of the most effective classes of recommendation engines, as they take the best features of both classes of recommendation engines.

## Utility of Recommendation Engines

In the previous chapter, we discussed an important requirement of any organization, understanding the customer. This requirement is made more important for online businesses, which have almost no physical interaction with their customers. Recommendation engines provide wonderful opportunities to these organizations to not only understand their clientele but also to use that information to increase their revenues. Another important advantage of recommendation engines is that they potentially have very limited downside. The worst thing the user can do is not pay attention to the recommendation made to him. The organization can easily integrate a crude recommendation engine in its interaction with the users and then, on the basis of its performance, make the decision to develop a more sophisticated version. Although unverified claims are often made about the impact of recommendation engines on the sales of major online service providers like Netflix, Amazon, YouTube, etc., an interesting insight into their effectiveness is provided by several papers. We encourage you to read one such paper at <http://ai2-s2-pdfs.s3.amazonaws.com/ba21/7822b81c3c9449014cb92e197d8a6baa4914.pdf>. The study claims that a good recommendation engine tends to increase sales volume by around 35% and also leads customers to discover more products, which in turn adds to a positive customer experience.

Before we start discussing various recommendation engines, we would like to thank our friend and fellow Data Scientist, Author and Course Instructor, Siraj Raval for helping us with a major chunk of the code used in this chapter pertaining to recommendation engines as well as sharing his codebase for developing our recommendation engines (check out Siraj’s GitHub at <https://github.com/11Sourcecell>). We would be modifying some of his code samples to develop the recommendation engines that we discuss in the subsequent sections. Interested readers can also check out Siraj’s YouTube channel at [www.youtube.com/c/sirajology](http://www.youtube.com/c/sirajology) where he makes excellent videos on machine learning, deep learning, artificial intelligence and other fun educational content.

## Popularity-Based Recommendation Engine

The simplest recommendation engine is naturally the easiest to develop. As we can easily develop recommendation engines, this type of recommendation engine is a very straightforward one to develop. The driving logic of this recommendation engine is that if some item is liked (or listened to) by a vast majority of our user base, then it is a good idea to recommend that item to users who have not interacted with that item.

The code to develop this kind of recommendation is extremely easy and is effectively just a summarization procedure. To develop these recommendations, we will determine which songs in our dataset have the most users listening to them and then that will become our standard recommendation set for each user. The code that follows defines a function that will do this summarization and return the resultant dataframe.

In [1]:

```
def create_popularity_recommendation(train_data, user_id, item_id):
    #Get a count of user_ids for each unique song as recommendation score
    train_data_grouped = train_data.groupby([item_id]).agg({user_id: 'count'}).reset_index()
    train_data_grouped.rename(columns = {user_id: 'score'},inplace=True)

    #Sort the songs based upon recommendation score
    train_data_sort = train_data_grouped.sort_values(['score', item_id], ascending = [0,1])

    #Generate a recommendation rank based upon score
    train_data_sort['Rank'] = train_data_sort['score'].rank(ascending=0, method='first')

    #Get the top 10 recommendations
    popularity_recommendations = train_data_sort.head(20)
    return popularity_recommendations
```

In [2]: recommendations = create\_popularity\_recommendation(triplet\_dataset\_sub\_song\_merged,'user','title')

In [3]: recommendations

We can use this function on our dataset to generate the top 10 recommendations to each of our users. The output of our plain vanilla recommendation system is shown in Figure 10-7. Here you can see that the recommendations are very similar to the list of the most popular songs that you saw in the last section, which is expected as the logic behind both is the same—only the output is different.

		title	score	Rank
19580	Sehr kosmisch		18629	1.0
5780	Dog Days Are Over (Radio Edit)		17636	2.0
27314	You're The One		16082	3.0
19542	Secrets		15139	4.0
18636	Revelry		14942	5.0
25070	Undo		14682	6.0
7531	Fireflies		13087	7.0
9641	Hey_ Soul Sister		12991	8.0
25216	Use Somebody		12790	9.0
9922	Horn Concerto No. 4 in E flat K495: II. Romanc...		12343	10.0
24291	Tive Sim		11825	11.0
3629	Canada		11591	12.0
23468	The Scientist		11534	13.0
4194	Clocks		11358	14.0
12136	Just Dance		11056	15.0

Figure 10-7. Recommendation by the popularity recommendation engine

## Item Similarity Based Recommendation Engine

In the last section, we witnessed one of the simplest recommendation engines. In this section we deal with a slightly more complex solution. This recommendation engine is based on calculating similarities between a user's items and the other items in our dataset.

Before we proceed further with our development effort, let's describe how we plan to calculate "item-item" similarity, which is central to our recommendation engine. Usually to define similarity among a set of items, we need a feature set on the basis of which both items can be described. In our case it will mean features of the songs on the basis of which one song can be differentiated from another. Although as we don't have ready access to these features (or do we?), we will define the similarity in terms of the users who listen to these songs. Confused? Consider this mathematical formula, which should give you a little more insight into the metric.

$$\text{similarity}_{ij} = \text{intersection}(\text{users}_i, \text{users}_j) / \text{union}(\text{users}_i, \text{users}_j)$$

This similarity metric is known as the Jaccard index ([https://en.wikipedia.org/wiki/Jaccard\\_index](https://en.wikipedia.org/wiki/Jaccard_index)) and in our case we can use it to define the similarities between two songs. The basic idea remains that if two songs are being listened to by a large fraction of common users out of the total listeners, the two songs can be said to be similar to each other. On the basis of this similarity metric, we can define the steps that the algorithm will take to recommend a song to a user  $k$ .

1. Determine the songs listened to by the user  $k$ .
2. Calculate the similarity of each song in the user's list to those in our dataset, using the similarity metric defined previously.
3. Determine the songs that are most similar to the songs already listened to by the user.
4. Select a subset of these songs as recommendation based on the similarity score.

As the Step 2 can become a computation-intensive step when we have a large number of songs, we will subset our data to 5,000 songs to make the computation more feasible. We will select the most popular 5,000 songs so it is quite unlikely that we would miss out on any important recommendations.

In [4]:

```
song_count_subset = song_count_df.head(n=5000)
user_subset = list(play_count_subset.user)
song_subset = list(song_count_subset.song)
triplet_dataset_sub_song_merged_sub = triplet_dataset_sub_song_merged[triplet_dataset_sub_song_merged.song.isin(song_subset)]
```

This code will subset our dataset to contain only most popular 5,000 songs. We will then create our similarity based recommendation engine and generate a recommendation for a random user. We leverage Siraj's Recommenders module here for the item similarity based recommendation system.

In [5]:

```
train_data, test_data = train_test_split(triplet_dataset_sub_song_merged_sub, test_size = 0.30, random_state=0)
is_model = Recommenders.item_similarity_recommender_py()
is_model.create(train_data, 'user', 'title')
user_id = list(train_data.user)[7]
user_items = is_model.get_user_items(user_id)
is_model.recommend(user_id)
```

The recommendations for random users are shown in Figure 10-8. Notice the stark difference from the popularity based recommendation engine. So this particular person is almost guaranteed to not like the most popular songs in our dataset.

	user_id	song	score	rank
0	2a2f776cbac6df64d6cb505e7e834e01684673b6	Meteor	0.099810	1
1	2a2f776cbac6df64d6cb505e7e834e01684673b6	Coda	0.093718	2
2	2a2f776cbac6df64d6cb505e7e834e01684673b6	Tuesday Moon	0.084476	3
3	2a2f776cbac6df64d6cb505e7e834e01684673b6	Tron	0.083682	4
4	2a2f776cbac6df64d6cb505e7e834e01684673b6	Acadian Coast	0.081797	5
5	2a2f776cbac6df64d6cb505e7e834e01684673b6	Love Letter To Japan	0.081042	6
6	2a2f776cbac6df64d6cb505e7e834e01684673b6	Heavy Water	0.080742	7
7	2a2f776cbac6df64d6cb505e7e834e01684673b6	Balloons (Single version)	0.079459	8
8	2a2f776cbac6df64d6cb505e7e834e01684673b6	Blackbirds	0.078346	9
9	2a2f776cbac6df64d6cb505e7e834e01684673b6	Diamond Dave	0.076680	10

**Figure 10-8.** Recommendation by the item similarity based recommendation engine

---

■ **Note** At the start of this section, we mentioned we don't readily have access to song's features that we can use to define similarity. As part of the million song database, we have those features available for each of the songs in the dataset. You are encouraged to replace this implicit similarity, based on common users, with the explicit similarity based on features of the song and see how the recommendations change.

---

## Matrix Factorization Based Recommendation Engine

Matrix factorization based recommendation engines are probably the most used recommendation engines when it comes to implementing recommendation engines in production. In this section, we give an intuition-based introduction to matrix factorization based recommendation engines. We avoid going into a heavily mathematical discussion, as from a practitioner's perspective the intent is to see how we can leverage this to get valuable recommendations from real data.

Matrix factorization refers to identification of two or more matrices from an initial matrix, such that when these matrices are multiplied we get the original matrix. Matrix factorization can be used to discover latent features between two different kinds of entities. What are these latent features? Let's discuss that for a moment before we go for a mathematical explanation.

Consider for a moment why you like a certain song—the answer may range from the soulful lyrics, to catchy music, to it being melodious, and many more. We can try to explain a song in mathematical terms by measuring its beats, tempo, and other such features and then define similar features in terms of the user. For example, we can define that from a user's listening history we know that he likes songs with beats that are bit on the higher side, etc. Once we have consciously defined such "features," we can use them to find matches for a user based on some similarity criteria. But more often than not, the tough part in this process is defining these features, as we have no handbook for what will make a good feature. It is mostly based on domain experts and a bit of experimentation. But as you will see in this section, you can use matrix factorization to discover these latent features and they seem to work great.

The starting point of any matrix factorization-based method is the utility matrix, as shown in Table 10-1. The utility matrix is a matrix of user X item dimension in which each row represents a user and each column stands for an item.

**Table 10-1.** Example of a Utility Matrix

	Item 1	Item 2	Item 3	Item 4	Item 5
User A	2				5
User B		1		5	
User C	5	1			

Notice that we have a lot of missing values in the matrix; these are the items that the user hasn't rated, either because he hasn't watched it or because he doesn't want to watch it. We can right away guess, say Item 4 is a recommendation for User C because User B and User C don't like Item 2, so it is likely they may end up liking the same items, in this case Item 4.

The process of matrix factorization means finding out a low rank approximation of the utility matrix. So we want to break down the utility matrix U into two low rank matrices so that we can recreate the matrix U by multiplying those two matrices. Mathematically,

$$R = U * I'$$

and

$$|R| = |U| * |I|$$

Here R is our original rating matrix, U is our user matrix, and I is our item matrix. Assuming the process helps us identify K latent features, our aim is to find two matrices X and Y such that their product (matrix multiplication) approximates R.

X = |U| x K matrix (A matrix with dimensions of num\_users \* factors)

Y = |P| x K matrix (A matrix with dimensions of factors \* num\_movies)

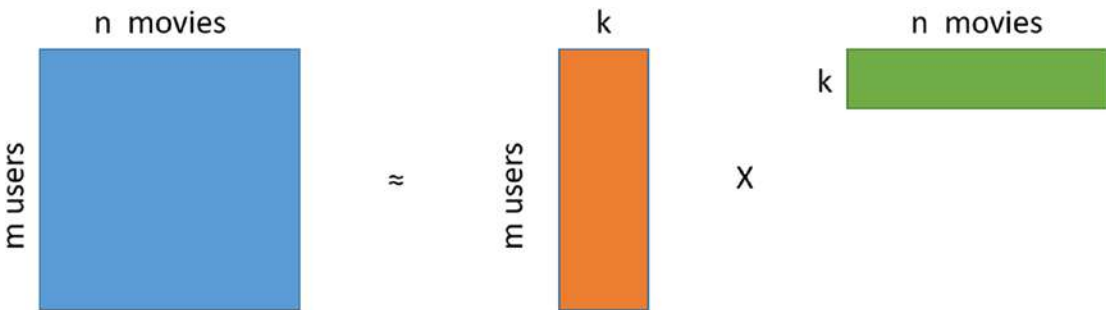

**Figure 10-9.** Matrix Factorization

We can also try to explain the concept of matrix factorization as an image. Based on Figure 10-9, we can regenerate the original matrix by multiplying the two matrices together. To make a recommendation to the user, we can multiply the corresponding user's row from the first matrix by the item matrix and determine the items from the row with maximum ratings. That will become our recommendations for the user. The first matrix represents the association between the users and the latent features, while the second matrix takes care of the associations between items (songs in our case) and the latent features. Figure 10-9 depicts a typical matrix factorization operation for a movie recommender system but the intent is to understand the methodology and extend it to build a music recommendation system in this scenario.

## Matrix Factorization and Singular Value Decomposition

There are multiple algorithms available for determining factorization of any matrix. We use one of the simplest algorithms, which is the singular value decomposition or SVD. Remember that we discussed the mathematics behind SVD in Chapter 1. Here, we explain how the decomposition provided by SVD can be used as matrix factorization.

You may remember from Chapter 1 that singular value decomposition of a matrix returns three different matrices: U, S, and V. You can follow these steps to determine the factorization of a matrix using the output of SVD function.

- Factorize the matrix to obtain U, S, and V matrices.
- Reduce the matrix S to first k components. (The function we are using will only provide k dimensions, so we can skip this step.)
- Compute the square root of reduced matrix  $S_k$  to obtain the matrix  $S_k^{1/2}$ .
- Compute the two resultant matrix  $U*S_k^{1/2}$  and  $S_k^{1/2}*V$  as these will serve as our two factorized matrices, as depicted in Figure 10-9.

We can then generate the prediction of user i for product j by taking the dot product of the  $i^{\text{th}}$  row of the first matrix with the  $j^{\text{th}}$  column of the second matrix. This information gives us all the knowledge required to build a matrix factorization based recommendation engine for our data.

## Building a Matrix Factorization Based Recommendation Engine

After the discussion of the mechanics of matrix factorization based recommendation engines, let's try to create such a recommendation engine on our data. The first thing that we notice is that we have no concept of "rating" in our data; all we have are the play counts of various songs. This is a well known problem in the case of recommendation engines and is called the "implicit feedback" problem. There are many ways to solve this problem but we will look at a very simple and intuitive solution. We will replace the play count with a fractional play count. The logic being that this will measure the strength of "likeness" for a song in the range of [0,1]. We can argue about better methods to address this problem, but this is an acceptable solution to our problem. The following code will complete the task.

```
In [7]:
triplet_dataset_sub_song_merged_sum_df = triplet_dataset_sub_song_merged[['user', 'listen_
count']].groupby('user').sum().rese
t_index()
triplet_dataset_sub_song_merged_sum_df.rename(columns={'listen_count': 'total_listen_
count'}, inplace=True)
triplet_dataset_sub_song_merged = pd.merge(triplet_dataset_sub_song_merged, triplet_dataset_
sub_song_merged_sum_df)
triplet_dataset_sub_song_merged['fractional_play_count'] = triplet_dataset_sub_song_
merged['listen_count']/triplet_dataset_s
ub_song_merged['total_listen_count']
```

The modified dataframe is shown in Figure 10-10.

	user	song	listen_count	fractional_play_count
0	d6589314c0a9bcbca4fee0c93b14bc402363afea	SOADQPP12A67020C82	12	0.036474
1	d6589314c0a9bcbca4fee0c93b14bc402363afea	SOAFTRR12AF72A8D4D	1	0.003040
2	d6589314c0a9bcbca4fee0c93b14bc402363afea	SOANQFY12AB0183239	1	0.003040
3	d6589314c0a9bcbca4fee0c93b14bc402363afea	SOAYATB12A6701FD50	1	0.003040
4	d6589314c0a9bcbca4fee0c93b14bc402363afea	SOBOAFP12A8C131F36	7	0.021277

**Figure 10-10.** Dataset with implicit feedback

The next transformation of data that is required is to convert our dataframe into a numpy matrix in the format of utility matrix. We will convert our dataframe into a sparse matrix, as we will have a lot of missing values and sparse matrices are suitable for representation of such a matrix. Since we won't be able to transform our song IDs and user IDs into a numpy matrix, we will convert these indices into numerical indices. Then we will use these transformed indices to create our sparse numpy matrix. The following code will create such a matrix.

```
In [8]:
from scipy.sparse import coo_matrix
small_set = triplet_dataset_sub_song_merged
user_codes = small_set.user.drop_duplicates().reset_index()
song_codes = small_set.song.drop_duplicates().reset_index()
user_codes.rename(columns={'index': 'user_index'}, inplace=True)
song_codes.rename(columns={'index': 'song_index'}, inplace=True)
song_codes['so_index_value'] = list(song_codes.index)
user_codes['us_index_value'] = list(user_codes.index)
small_set = pd.merge(small_set, song_codes, how='left')
small_set = pd.merge(small_set, user_codes, how='left')
mat_candidate = small_set[['us_index_value', 'so_index_value', 'fractional_play_count']]
data_array = mat_candidate.fractional_play_count.values
row_array = mat_candidate.us_index_value.values
col_array = mat_candidate.so_index_value.values
data_sparse = coo_matrix((data_array, (row_array, col_array)), dtype=float)
```

```
In [8]: data_sparse
Out : <99996x30000 sparse matrix of type '<class 'numpy.float64'>'
      with 10774785 stored elements in COOrdinate format>
```

Once we have converted our matrix into a sparse matrix, we will use the `svds` function provided by the `scipy` library to break down our utility matrix into three different matrices. We can specify the number of latent factors we want to factorize our data. In the example we will use 50 latent factors but users are encouraged to experiment with different values of latent factors and observe how the recommendation change as a result. The following code creates the decomposition of our matrix and predicts the recommendation for the same user as in the item similarity recommendation use case. We leverage our `compute_svd(...)` function to perform the SVD operation and then use the `compute_estimated_matrix(...)` for the low rank matrix approximation after factorization. Detailed steps with function implementations as always are present in the jupyter notebook.



```

In [9]:
K=50
#Initialize a sample user rating matrix
urm = data_sparse
MAX_PID = urm.shape[1]
MAX_UID = urm.shape[0]

#Compute SVD of the input user ratings matrix
U, S, Vt = compute_svd(urm, K)
uTest = [27513]

#Get estimated rating for test user
print("Predicted ratings:")
uTest_recommended_items = compute_estimated_matrix(urm, U, S, Vt, uTest, K, True)
for user in uTest:
    print("Recommendation for user with user id {}".format(user))
    rank_value = 1
    for i in uTest_recommended_items[user,0:10]:
        song_details = small_set[small_set.so_index_value == i].drop_duplicates('so_index_value')[['title','artist_name']]
        print("The number {} recommended song is {} BY {}".format(rank_value, list(song_details['title'])[0],list(song_details['artist_name'])[0]))
        rank_value+=1

```

The recommendations made by the matrix factorization based system are also shown in Figure 10-11. If you refer to the jupyter notebook for the code, you will observe that the user with ID 27513 is the same one for whom we performed the item similarity based recommendations earlier. Refer to the notebook for further details on how the different functions we used earlier have been implemented and used for our recommendations! Note how the recommendations have changed from the previous two systems. It looks like this user might like listening to some Coldplay and Radiohead, definitely interesting!

```

Recommendation for user with user id 27513
The number 1 recommended song is Behind The Sea [Live In Chicago] BY Panic At The Disco
The number 2 recommended song is Una Confusion BY LU
The number 3 recommended song is Home BY Edward Sharpe & The Magnetic Zeros
The number 4 recommended song is Dead Souls BY Nine Inch Nails
The number 5 recommended song is The City Is At War (Album Version) BY Cobra Starship
The number 6 recommended song is Tighten Up BY The Black Keys
The number 7 recommended song is Climbing Up The Walls BY Radiohead
The number 8 recommended song is Yellow BY Coldplay
The number 9 recommended song is Creep (Explicit) BY Radiohead
The number 10 recommended song is West One (Shine On Me) BY The Ruts

```

**Figure 10-10.** Recommendation using the matrix factorization based recommender

We used one of the simplest matrix factorization algorithms for our use case; you can try to find out other more sophisticated implementation of the matrix factorization routine, which will lead to a different recommendation system. Another topic which we have ignored a bit is the conversion of song play count into a measure of “implicit feedback”. The system that we chose is acceptable but is far from perfect. There is a lot of literature that discusses the handling of this issue. We encourage you to find different ways of handling it and experiment with various measures!

## A Note on Recommendation Engine Libraries

You might have noticed that we did not use any readily available packages for building our recommendation system. Like for every possible task, Python has multiple libraries available for building recommendation engines too. But we have refrained from using such libraries because we wanted to give you a taste of what goes on behind a recommendation engine. Most of these libraries will take the sparse matrix format as input data and allow you to develop recommendation engines. We encourage you to continue with your experimentation with at least one of those libraries, as it will give you an idea of exploring different possible implementations of the same problem and the differences those implementations can make. Some libraries that you can use for such exploration include `scikit-surprise`, `lightfm`, `crab`, `rec_sys`, etc.

## Summary

In this chapter, we learned about recommendation systems, which are an important and widely known Machine Learning application. We discovered a very popular data source that allowed us to peek inside a small section of online music listeners. We then started on the learning curve of building different types of recommendation engines. We started with a simple vanilla version based on popularity of songs. After that, we upped the complexity quotient of our recommendation engines by developing an item similarity based recommendation engine. We urge you to extend that recommendation engine using the metadata provided as part of million song database. Finally, we concluded the chapter by building a recommendation engine that takes an entirely different point of view. We explored some basics of matrix factorization and learned how a very basic factorization method like singular value decomposition can be used for developing recommendations. We ended the chapter by mentioning about the different libraries that you can use to develop sophisticated engines from the dataset that we created.

We would like to close this chapter by further underlining the importance of recommendation engines, especially in the context of online content delivery. An uncorroborated fact that's often associated with recommendation systems is that "60% of Netflix movie viewings are through recommendations". According to Wikipedia, Netflix has an annual revenue of around \$8 billion. Even if half of that is coming from movies and even if the figure is 30% instead of 60%, it means that around \$1 billion of Netflix revenue can be attributed to recommendation engines. Although we will never be able to verify these figures, they are definitely a strong argument for recommendation engines and the value they can generate.

## CHAPTER 11



# Forecasting Stock and Commodity Prices

In the chapters so far, we covered a variety of concepts and solved diverse real-world problems. In this chapter, we will dive into forecast/prediction use cases. Predictive analytics or modeling involves concepts from data mining, advanced statistics, Machine Learning, and so on to model historical data to forecast future events. Predictive modeling has use cases across domains such as financial services, healthcare, telecommunications, etc.

There are a number of techniques developed over the years to understand temporal data and model patterns to score future events and behaviors. *Time series analysis* forms the descriptive aspect of such data and the understanding helps in modeling and forecasting the same. Traditional approaches like *regression analysis* (see Chapter 6) and *Box-Jenkins methodologies* have been deeply studied and applied over the years. More recently, improvements in computation and Machine Learning algorithms have seen Machine Learning techniques like *neural networks* or to be more specific, Deep Learning, making a headway in forecasting use cases with some amazing results.

This chapter discusses forecasting using stock and commodity price datasets. We will utilize traditional time series models as well as deep learning models like recurrent neural networks to forecast the prices. Through this chapter, we will cover the following topics:

- Brief overview of time series analysis
- Forecasting commodity pricing using traditional approaches like ARIMA
- Forecasting stock prices with newer deep learning approaches like RNNs and LSTMs

The code samples, jupyter notebooks, and sample datasets for this chapter is available in the GitHub repository for this book at <https://github.com/dipanjanS/practical-machine-learning-with-python> under the directory/folder for Chapter 11.

## Time Series Data and Analysis

A time series is a sequence of observed values in a time-ordered manner. The observations are recorded at equally spaced time intervals. Time series data is available and utilized in the fields of statistics, economics, finance, weather modeling, pattern recognition, and many more.

*Time series analysis* is the study of underlying structure and forces that produced observations. It provides descriptive frameworks to analyze characteristics of data and other meaningful statistics. It also provides techniques to then utilize this to fit a model to forecast, monitor, and control.

There is another school of thought that separates the descriptive and modeling components of time series. Here, time series analysis typically is concerned with only the descriptive analysis of time series data to understand various components and underlying structure. The modeling aspect that utilizes time series

for prediction/forecasting use cases is termed as *time series forecasting*. Though in general, both schools of thought utilize the same set of tools and techniques. It is more about how the concepts are grouped for a structured learning and application.

---

■ **Note** Time series and its analysis is a complete field of study on its own and we merely discuss certain concepts and techniques for our use cases here. This chapter is by no means a complete guide on time series and its analysis.

---

Time series can be analyzed both in frequency and time domains. The frequency domain analysis includes spectral and wavelet analysis techniques, while time domain includes auto- and cross-correlation analysis. In this chapter, we primarily focus on time series forecasting in the time domain with a brief discussion around descriptive characteristics of time series data. Moreover, we concentrate on univariate time series analysis (time is an implicit variable).

To better understand concepts related to time series, we utilize a sample dataset. The following snippet loads a web site visit data with a daily frequency using pandas. You can refer to the jupyter notebook `notebook_getting_started_time_series.ipynb` for the necessary code snippets and examples. The dataset is available at <http://openmv.net/info/website-traffic>.

```
In [1] : import pandas as pd
...:
...: #load data
...: input_df = pd.read_csv(r'website-traffic.csv')
...:
...: input_df['date_of_visit'] = pd.to_datetime(input_df.MonthDay.\
...:                                         str.cat( input_df.Year.astype(str),
...:                                         sep=' '))
```

The snippet first creates a new attribute called the `date_of_visit` using a combination of Day, Month, and Year values available in the base dataframe. Since the dataset is about web site visits per day, the variable of interest is the visit count for the day with the time dimension, i.e. `date_of_visit` being the implicit one. The output plot of visits per day is shown in Figure 11-1.

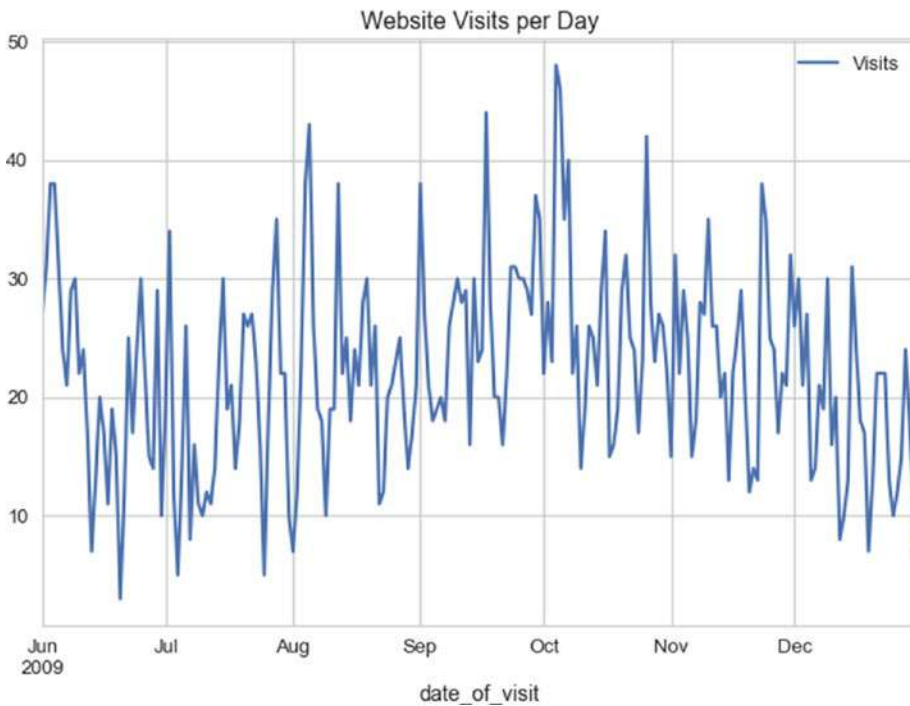

**Figure 11-1.** Web site visits per day

## Time Series Components

The time series at hand is data related to web site visits per day for a given web site. As mentioned earlier, time series analysis deals with understanding the underlying structure and forces that result in the series as we see it. Let's now try to deconstruct various components that make up the time series at hand. A time series is said to be comprised of the following three major components:

- **Seasonality:** These are the periodic fluctuations in the observed data. For example, weather patterns or sale patterns.
- **Trend:** This is the increasing or decreasing behavior of the series with time. For example, population growth patterns.
- **Residual:** This is the remaining signal after removing the seasonality and trend signals. It can be further decomposed to remove the noise component as well.

It is interesting to note that most real-world time series data have a combination or all of these components available. Yet, it is mostly the noise that's always apparently present, with trend and seasonality being optional in certain cases. In the following snippet, we utilize `statsmodels` to decompose our web site visit time series into its three constituents and then plot the same.

```
In [2] : from statsmodels.tsa.seasonal import seasonal_decompose
...:
...: # extract visits as series from the dataframe
...: ts_visits = pd.Series(input_df.Visits.values,
```

```

...:         index=pd.date_range(
...:             input_df.date_of_visit.min(),
...:             input_df.date_of_visit.max(),
...:             freq='D')
...:     )
...:
...:     decompose = seasonal_decompose(ts_visits.interpolate(),
...:                                   freq=24)
...:     decompose.plot()

```

We first create a pandas Series object with additional care taken to set the frequency of the time series index. It is important to note that statsmodels has a number of time series modeling modules available and they rely on underlying data structures (such as pandas, numpy, etc.) to specify the frequency of the time series. In this case, since the data is at a daily level, we set the frequency of ts\_visits object to 'D' denoting a daily frequency. We then simply use the seasonal\_decompose() function from statsmodels to get the required constituents. The decomposed series is shown in the plot in Figure 11-2.

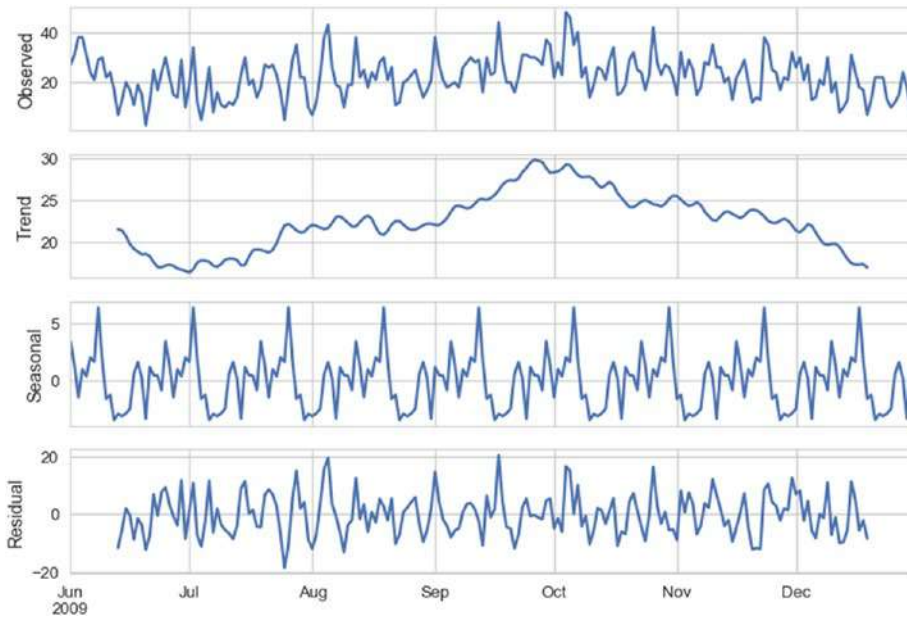

**Figure 11-2.** Web site visit time series and its constituent signals

It is apparent from Figure 11-2, the time series at hand has both upward and downward trends in it. It shows a gradual increasing trend until October, post which it starts a downward behavior. The series certainly has a monthly periodicity or seasonality to it. The remaining signal is what is marked as residual in Figure 11-2.

## Smoothing Techniques

As discussed in the previous chapters, preprocessing the raw data depends upon the data as well as the use case requirements. Yet there are certain standard preprocessing techniques for each type of data. Unlike the datasets we have seen so far, where we consider each observation to be independent of other (past or future) observations, time series have inherent dependency on historical observations. As seen from the decomposition of web site visits series, there are multiple factors impacting each observation. It is an inherent property of time series data to have random variation to it apart from its other constituents. To better understand, model, and utilize time series for prediction related tasks, we usually perform a preprocessing step better termed as *smoothing*. Smoothing helps reduce the effect of random variation and helps clearly reveal the seasonality, trend, and residual components of the series. There are various methods to smooth out a time series. They are broadly categorized as follows.

### Moving Average

Instead of taking an average of complete time series (which we do in cases of non-temporal data) to summarize, moving average makes use of a rolling windowed approach. In this case, we compute the mean of each successive smaller windows of past data to smoothen out the impact of random variation. The following is a general formula for moving average calculation.

$$MA_t = \frac{x_t + x_{t-1} + x_{t-2} + \dots + x_{t-n}}{n}$$

Where,  $MA_t$  is the moving average for time period  $t$ ,  $x_t$ ,  $x_{t-1}$  and so on denote observed values at particular time periods, and  $n$  is the window size. For example, the following snippet calculates the moving average for visits with a window size of 3.

```
In [3] : # moving average
...: input_df['moving_average'] = input_df['Visits'].rolling(window=3,
...:                                                         center=False).mean()
...:
...:
...: print(input_df[['Visits','moving_average']].head(10))
...:
...: plt.plot(input_df.Visits, '-', color='black', alpha=0.3)
...: plt.plot(input_df.moving_average, color='b')
...: plt.title('Website Visit and Moving Average Smoothing')
...: plt.legend()
...: plt.show()
```

The moving average calculated using a window size 3 has the following results. It should be pretty clear that for a window size of 3, the first two observations would not have any moving averages available, hence the NaN.

```
Out[3]:
  Visits  moving_average
0      27              NaN
1      31              NaN
2      38      32.000000
3      38      35.666667
4      31      35.666667
```

5	24	31.000000
6	21	25.333333
7	29	24.666667
8	30	26.666667
9	22	27.000000

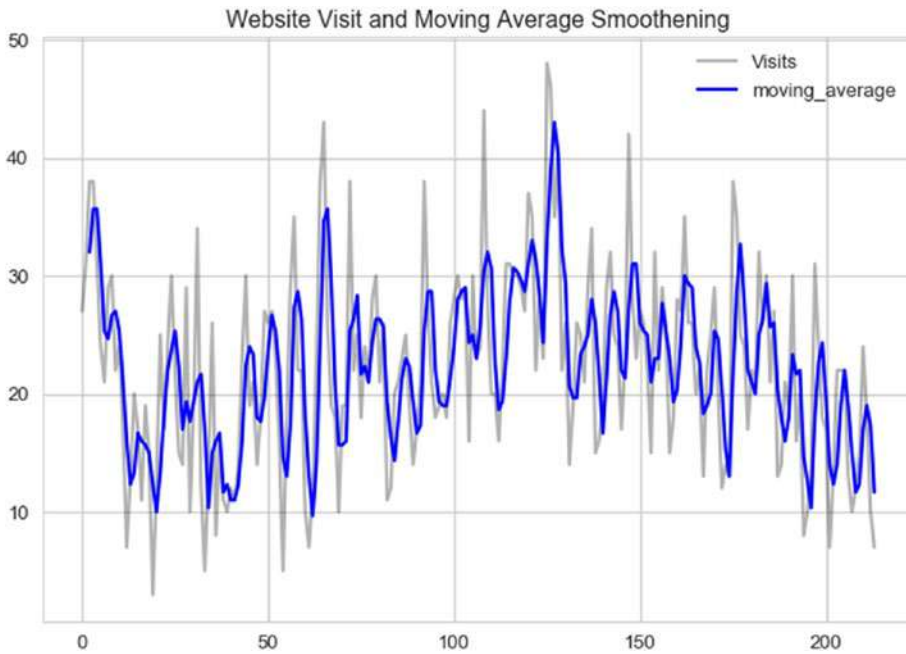

**Figure 11-3.** Smoothing using moving average

The plot in Figure 11-3 shows the smoothed visits time series. The smoothed series captures the overall structure of the original series all the while reducing the random variation in it. You are encouraged to explore and experiment with different window sizes and compare the results.

Depending on the use case and data at hand, we also try different variations of moving average like *centered moving average*, *double moving average*, and so on apart from different window sizes. We will utilize some of these concepts when we deal with actual use cases in the coming sections of the chapter.

## Exponential Smoothing

Moving average based smoothing is effective yet it is a pretty simple preprocessing technique. In case of moving average, all past observations in the window are given equal weight. Unlike the previous method, exponential smoothing techniques apply exponentially decreasing weights to older observations. In simple words, exponential smoothing methods give more weight to recent past observations as compared to older observations. Depending on the level of smoothing required, there may be one or more smoothing parameters to set in case of exponential smoothing.



Exponential smoothing is also called *exponentially weighted moving average* or EWMA for short. Single exponential smoothing is one of the simplest to get started with. The general formula is given as.

$$E_t = \alpha y_{t-1} + (1-\alpha)E_{t-1}$$

Where,  $E_t$  is the  $t^{\text{th}}$  smoothed observation,  $y$  is the actual observed value at  $t-1$  instance, and  $\alpha$  is smoothing constant between 0 and 1. There are different methods to bootstrap the value of  $E_2$  (the time period from which smoothing begins). It can be done by setting it to  $y_1$  or an average of first  $n$  time periods and so on. Also, the value of  $\alpha$  determines how much of the past is accounted for. A value closer to 1 dampens out the past observations quickly while values closer to 0 dampen out slowly. The following snippet uses the pandas `ewm()` function to calculate the smoothed series for visits. The parameter `halflife` is used to calculate  $\alpha$  in this case.

```
In [4] : input_df['ewma'] = input_df['Visits'].ewm(halflife=3,
...:                                             ignore_na=False,
...:                                             min_periods=0,
...:                                             adjust=True).mean()
...:
...: plt.plot(input_df.Visits, '-', color='black', alpha=0.3)
...: plt.plot(input_df.ewma, color='g')
...: plt.title('Website Visit and Exponential Smoothing')
...: plt.legend()
...: plt.show()
```

The plot depicted in Figure 11-4 showcases the EWMA smoothed series along with the original one.

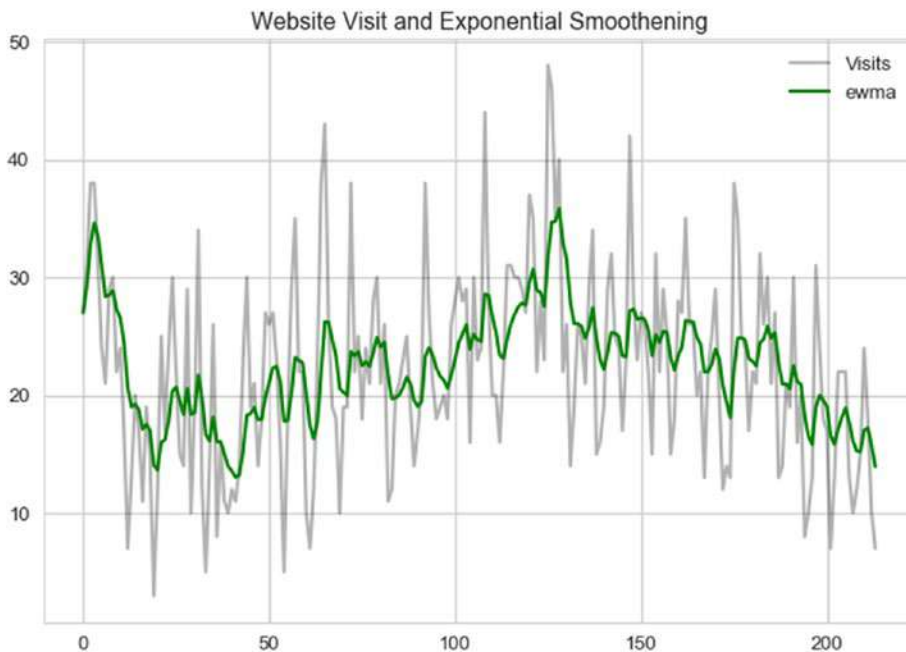

**Figure 11-4.** Smoothing using EWMA

In the coming sections, we will apply our understanding of time series, preprocessing techniques, and so on to solve stock and commodity price forecasting problems using different forecasting methods.

## Forecasting Gold Price

Gold, the yellow shiny metal, has been the fancy of mankind since ages. From making jewelry to being used as an investment, gold covers a huge spectrum of use cases. Gold, like other metals, is also traded on the commodities indexes across the world. For better understanding time series in a real-world scenario, we will work with gold prices collected historically and predict its future value. Let's begin by first formally stating the problem statement.

### Problem Statement

Metals such as gold have been traded for years across the world. Prices of gold are determined and used for trading the metal on commodity exchanges on a daily basis using a variety of factors. Using this daily price-level information *only*, our task is to predict future price of gold.

### Dataset

For any problem, first and foremost is the data. Stock and Commodity exchanges do a wonderful job of storing and sharing daily level pricing data. For the purpose of this use case, we will utilize gold pricing from Quandl. Quandl is a platform for financial, economic, and alternative datasets. You can refer to the jupyter notebook `notebook_gold_forecast_arima.ipynb` for the necessary code snippets and examples.

To access publicly shared datasets on Quandl, we can use the `pandas-datareader` library as well as `quandl` (library from Quandl itself). For this use case, we will depend upon `quandl`. Kindly install the same using `pip` or `conda`. The following snippet shows a quick one-liner to get your hands on gold pricing information since 1970s.

```
In [5]: import quandl
...: gold_df = quandl.get("BUNDESBANK/BBK01_WT5511", end_date="2017-07-31")
```

The `get()` function takes the stock/commodity identifier as first parameter followed by the date until which we need the data. Note that not all datasets are public, for some of them, API access must be obtained.

### Traditional Approaches

Time series analysis and forecasting have been long studied in detail. There are matured and extensive set of modeling techniques available for the same. Out of the many, the following are a few most commonly used and explored techniques:

- Simple moving average and exponential smoothing based forecasting
- Holt's, Holt-Winter's Exponential Smoothing based forecasting
- Box-Jenkins methodology (AR, MA, ARIMA, S-ARIMA, etc.)

---

■ **Note** Causal or cross-sectional forecasting/modeling is where the target variable has a relationship with one or more predictor variables, example regression models (see Chapter 6). Time series forecasting is about forecasting variable(s) that is changing over time. Both these techniques are grouped under quantitative techniques.

---

As mentioned, there are quite a handful of techniques available, each a deep topic of research and study. For the scope of this section and chapter, we will focus upon *ARIMA* models (from the Box-Jenkin's methodology) to forecast gold prices. Before we move ahead and discuss ARIMA, let's look at a few key concepts.

## Key Concepts

- **Stationarity:** One the key assumptions behind the ARIMA models we will be discussing next. Stationarity refers to the property where for a time series its mean, variance, and autocorrelation are time invariant. In other words, mean, variance, and autocorrelation do not change with time. For instance, a time series having an upward (or downward) trend is a clear indicator of a non-stationarity because its mean would change with time (see web site visit data example in the previous section).
- **Differencing:** One of the methods of stationarizing series. Though there can be other transformations, differencing is widely used to stabilize the mean of a time series. We simply compute difference between consecutive observations to obtain a differenced series. We can then apply different tests to confirm if the resulting series is stationary or not. We can also perform *second order differencing*, *seasonal differencing*, and so on, depending on the time series at hand.
- **Unit Root Tests:** Statistical tests that help us understand if a given series is stationary or not. *The Augmented Dickey Fuller* test begins with a null hypothesis of series being non-stationary, while *Kwiatkowski-Phillips-Schmidt-Shin* test or KPSS has a null hypothesis that the series is stationary. We then perform a regression fit to reject or fail to reject the null hypothesis.

## ARIMA

The Box-Jenkin's methodology consists of a wide range of statistical models which are widely used to model time series for forecasting. For this section, we will be concentrating on one such model called as ARIMA.

ARIMA stands for *Auto Regressive Integrated Moving Average* model. Sounds pretty complex, right? Let's look at the basics and constituents of this model and then build on our understanding to forecast gold prices.

- **Auto Regressive or AR Modeling:** A simple linear regression model where current observation is regressed upon one or more prior observations. The model is denoted as.

$$X_t = \delta + \theta_1 X_{t-1} + \dots + \theta_p X_{t-p} + \varepsilon_t$$

where,  $X_t$  is the observation at time  $t$ ,  $\varepsilon_t$  is the noise and

$$\delta = \left( 1 - \sum_{i=1}^p \theta_i \right) \mu$$

the dependency on prior values is denoted by  $p$  or the order of AR model.

- **Moving Average or MA Modeling:** Is again essentially a linear regression model that models the impact of noise/error from prior observations to current one. The model is denoted as

$$X_t = \mu + \varepsilon_t - \phi_1 \varepsilon_{t-1} + \dots + \phi_q \varepsilon_{t-q}$$

where,  $\mu$  is the series mean,  $\varepsilon_t$  are the noise terms, and  $q$  is the order of the model.

The AR and MA models were known long before Box-Jenkin's methodology was presented. Yet this methodology presented a systematic approach to identify and apply these models for forecasting.

---

■ **Note** Box, Jenkins, and Reinsel presented this methodology in their book titled *Time Series Analysis: Forecasting and Control*. You are encouraged to go through it for a deeper understanding.

---

The ARIMA model is a logical progression and combination of the two models. Yet if we combine AR and MA with a differenced series, what we get is called as *ARIMA(p,d,q)* model. where,

- **p** is the order of Autoregression
- **q** is the order of Moving average
- **d** is the order of differencing

Thus, for a stationary time series ARIMA models combine autoregressive and moving average concepts to model the behavior of a long running time series and helps in forecasting. Let's now apply these concepts to model gold price forecasting.

## Modeling

While describing the dataset, we extracted the gold price information using `quandl`. Let's first plot and see how this time series looks. The following snippet uses the `pandas` to plot the same.

```
In [6]: gold_df.plot(figsize=(15, 6))
...: plt.show()
```

The plot in Figure 11-5 shows a general upward trend with sudden rise in the 1980s and then near 2010.

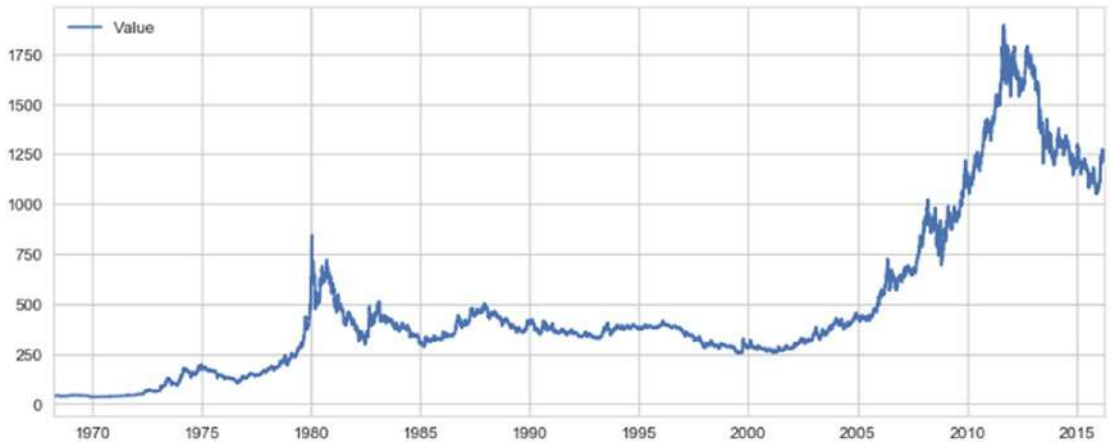

**Figure 11-5.** Gold prices over the years

Since stationarity is one of the primary assumptions of ARIMA models, we will utilize *Augmented Dickey Fuller* test to check our series for *stationarity*. The following snippet helps us calculate the AD Fuller test statistics and plot rolling characteristics of the series.

```
In [7]: # Dickey Fuller test for Stationarity
...: def ad_fuller_test(ts):
...:     dftest = adfuller(ts, autolag='AIC')
...:     dfoutput = pd.Series(dftest[0:4], index=['Test Statistic',
...:                                           'p-value',
...:                                           '#Lags Used',
...:                                           'Number of Observations Used'])
...:     for key,value in dftest[4].items():
...:         dfoutput['Critical Value (%s)'%key] = value
...:     print(dfoutput)
...:
...: # Plot rolling stats for a time series
...: def plot_rolling_stats(ts):
...:     rolling_mean = ts.rolling(window=12,center=False).mean()
...:     rolling_std = ts.rolling(window=12,center=False).std()
...:
...:     #Plot rolling statistics:
...:     orig = plt.plot(ts, color='blue',label='Original')
...:     mean = plt.plot(rolling_mean, color='red', label='Rolling Mean')
...:     std = plt.plot(rolling_std, color='black', label = 'Rolling Std')
...:     plt.legend(loc='best')
...:     plt.title('Rolling Mean & Standard Deviation')
...:     plt.show(block=False)
```

If the test statistic of AD Fuller test is less than the critical value(s), we reject the null hypothesis of non-stationarity. The AD Fuller test is available as part of the `statsmodels` library. Since it is quite evident that our original series of gold prices is non-stationary, we will perform a log transformation and see if we are able to obtain stationarity. The following snippet uses the rolling stats plots and AD Fuller tests to check the same.

```
In [8]: log_series = np.log(gold_df.Value)
...:
...: ad_fuller_test(log_series)
...: plot_rolling_stats(log_series)
```

The test statistic of -1.8 is greater than either of critical values, hence we fail to reject the null hypothesis, i.e., the series is non-stationary even after log transformation. The output and plot depicted in Figure 11-6 confirm the same.

```
Test Statistic           -1.849748
p-value                  0.356057
#Lags Used               29.000000
Number of Observations Used 17520.000000
Critical Value (1%)      -3.430723
Critical Value (5%)      -2.861705
Critical Value (10%)     -2.566858
dtype: float64
```

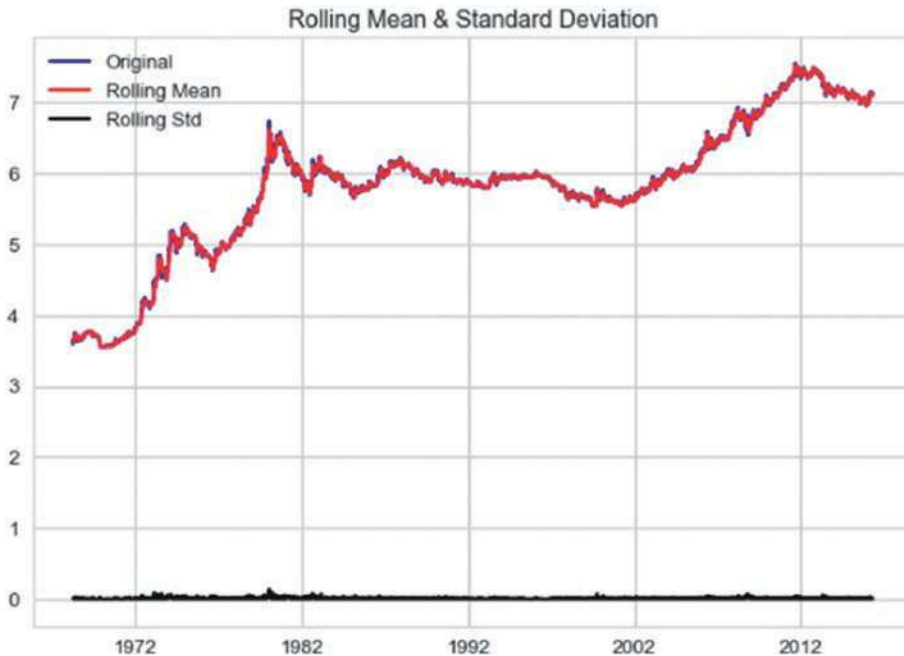

**Figure 11-6.** Rolling mean and standard deviation plot for log transformed gold price

The plot points out a time varying mean of the series and hence the non-stationarity. As discussed in the key concepts, differencing a series helps in achieving stationarity. In the following snippet, we prepare a first order differenced log series and perform the same tests.

```
In [9]: log_series_shift = log_series - log_series.shift()
...: log_series_shift = log_series_shift[~np.isnan(log_series_shift)]
...:
...: ad_fuller_test(log_series_shift)
...: plot_rolling_stats(log_series_shift)
```

The test statistic at -23.91 is lower than even 1% critical value, thus we reject the null hypothesis for AD Fuller test. The following are the test results.

Test Statistic	-23.917175
p-value	0.000000
#Lags Used	28.000000
Number of Observations Used	17520.000000
Critical Value (1%)	-3.430723
Critical Value (5%)	-2.861705
Critical Value (10%)	-2.566858
dtype:	float64

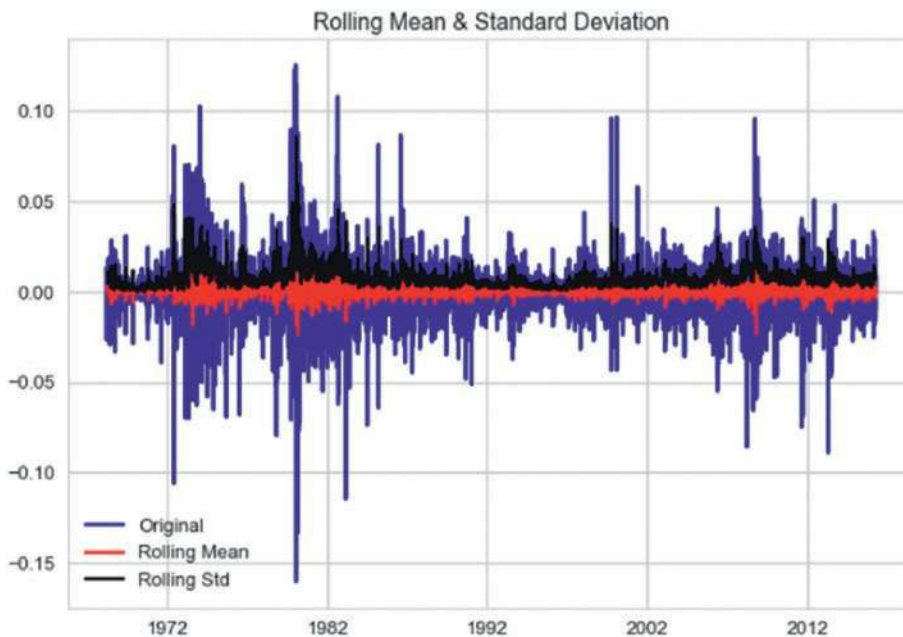

**Figure 11-7.** Rolling mean and standard deviation plot for log differenced gold price series

This exercise points us to the fact that we need to use a log differenced series for ARIMA to model the dataset at hand. See Figure 11-7. Yet we still need to figure out the order of autoregression and moving average components, i.e.,  $p$  and  $q$ .

Building an ARIMA model requires some experience and intuition as compared other models. Identifying  $p$ ,  $d$ , and  $q$  parameters of the model can be done using different methods, though arriving at the right set of numbers is dependent both upon requirements and experience.

One of the commonly used methods is the plotting of ACF and PACF plots to determine  $p$  and  $q$  values. **ACF** or Auto Correlation Function plot and **PACF** or the Partial Auto Correlation Function plot helps us narrow down the search space of determining the  $p$  and  $q$  values with a few caveats. There are certain rules or heuristics developed over the years to best utilize these plots and thus these do not guarantee the best possible values.

The ACF plot helps us understand the correlation of an observation with its lag (or previous value). The ACF plot is used to determine the MA order, i.e.  $q$ . The value at which ACF drops is the order of the MA model.

On the same lines, PACF points toward correlation between an observation and a specific lagged value, excluding effect of other lags. The value at which PACF drops points toward the order of AR model or the  $p$  in ARIMA( $p,d,q$ ).

---

■ **Note** Further details on ACF and PACF is available at <http://www.itl.nist.gov/div898/handbook/eda/section3/autocopl.htm>.

---

Let's again utilize `statsmodels` to generate ACF and PACF plots for our series and try to determine  $p$  and  $q$  values. The following snippet uses the log differenced series to generate the required plots.

```
In [10]: fig = plt.figure(figsize=(12,8))
...: ax1 = fig.add_subplot(211)
...: fig = sm.graphics.tsa.plot_acf(log_series_shift.squeeze(), lags=40, ax=ax1)
...: ax2 = fig.add_subplot(212)
...: fig = sm.graphics.tsa.plot_pacf(log_series_shift, lags=40, ax=ax2)
```

The output plots (Figure 11-8) show a sudden drop at lag 1 for both ACF and PACF, thus pointing toward possible values of  $q$  and  $p$  to be 1 each, respectively.



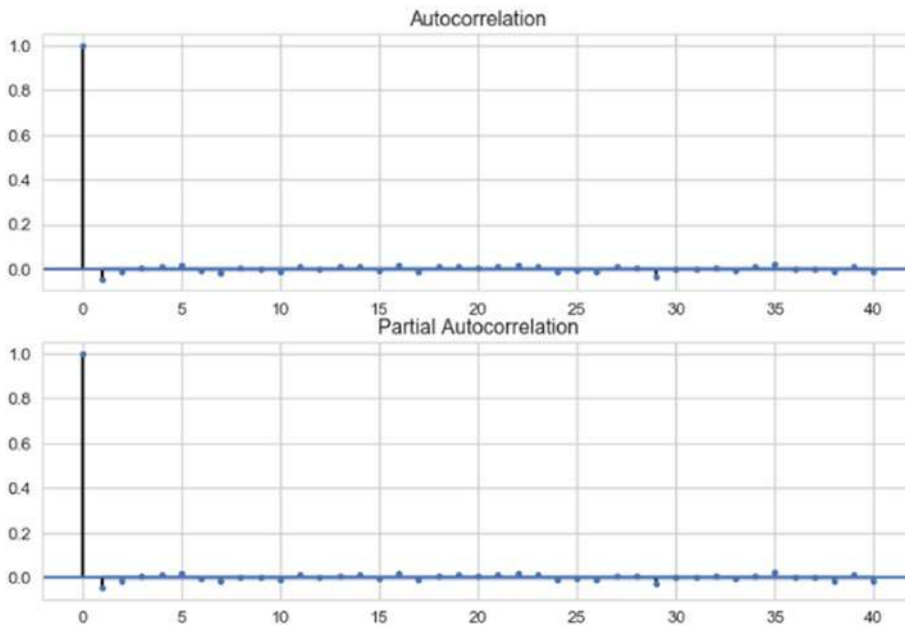

**Figure 11-8.** ACF and PACF plots

The ACF and PACF plot also help us understand if a series is stationary or not. If a series has gradually decreasing values for ACF and PACF, it points toward non-stationarity property in the series.

---

■ **Note** Identifying the  $p$ ,  $d$ , and  $q$  values for any ARIMA model is as much science as it is art. More details on this are available at <https://people.duke.edu/~rnau/411arim.htm>.

---

Another method to derive the  $p$ ,  $d$ ,  $q$  parameters is to perform a grid search of the parameter space. This is more in tune with the Machine Learning way of hyperparameter tuning. Though `statsmodels` does not provide such a utility (for obvious reasons though), we can write our own utility to identify the best fitting model. Also, pretty much like any other Machine Learning/Data Science use case, we need to split our dataset into train and test sets. We utilize `scikit-learn`'s `TimeSeriesSplit` utility to help us get proper training and testing sets.

We write a utility function `arima_grid_search_cv()` to grid search and cross validate the results using the gold prices at hand. The function is available in `arima_utils.py` module for reference. The following snippet performs a five-fold cross validation with auto-ARIMA to find the best fitting model.

```
In [11]: results_dict = arima_gridsearch_cv(gold_df.log_series,cv_splits=5)
```

Note that we are passing the log transformed series as input to the `arima_gridsearch_cv()` function. As we saw earlier, the log differenced series was what helped us achieve stationarity, hence we use the log transformation as our starting point and fit an ARIMA model with  $d$  set to 1. The function call generates a detailed output for each train-test split (we have five of them lined up), each iteration performing a grid search over  $p$ ,  $d$ , and  $q$ . Figure 11-9 shows the output of the first iteration, where the training set included only 2924 observations.

```

*****
Iteration 1 of 5
TRAIN: [ 0  1  2 ..., 2922 2923 2924] TEST: [2925 2926 2927 ..., 5847 5848 5849]
Train shape:(2925,), Test shape:(2925,)
ARIMA(0, 0, 0)- AIC:5358.675881541096
ARIMA(0, 0, 1)- AIC:1370.644173716044
ARIMA(0, 1, 0)- AIC:-17795.53995335306
ARIMA(0, 1, 1)- AIC:-17793.56497363464
ARIMA(1, 0, 0)- AIC:-17788.098388741855
ARIMA(1, 0, 1)- AIC:-17786.10419500408
ARIMA(1, 1, 0)- AIC:-17793.562143972762
ARIMA(1, 1, 1)- AIC:-17796.006063269502
Best Model params:(1, 1, 1) AIC:-17796.006063269502
    
```

**Figure 11-9.** Auto ARIMA

Similar to our findings using ACF-PACF, auto ARIMA suggests that the best fitting model is ARIMA(1,1,1) based upon the AIC criteria. Note that AIC or *Akaike Information Criterion* measures the goodness of fit and parsimony. It is a relative metric and does not point toward quality of models in an absolute sense, i.e., if all models being compared are poor, AIC will not be able to point that out. Thus, AIC should be used as a heuristic. A low value points toward a better fitting model. The following is the summary generated by the ARIMA(1,1,1) fit, see Figure 11-10.

ARIMA Model Results						
Dep. Variable:	D.log_series	No. Observations:	2924			
Model:	ARIMA(1, 1, 1)	Log Likelihood	8902.003			
Method:	css-mle	S.D. of innovations	0.012			
Date:	Sat, 02 Sep 2017	AIC	-17796.006			
Time:	18:11:07	BIC	-17772.083			
Sample:	04-02-1968	HQIC	-17787.390			
	- 04-03-1976					
-----						
	coef	std err	z	P> z	[0.025	0.975]
-----						
const	0.0004	0.000	1.934	0.053	-5.59e-06	0.001
ar.L1.D.log_series	-0.7385	0.120	-6.129	0.000	-0.975	-0.502
ma.L1.D.log_series	0.7649	0.115	6.668	0.000	0.540	0.990
-----						
Roots						
-----						
	Real	Imaginary	Modulus	Frequency		
-----						
AR.1	-1.3540	+0.0000j	1.3540	0.5000		
MA.1	-1.3073	+0.0000j	1.3073	0.5000		
-----						

**Figure 11-10.** Summary of ARIMA(1,1,1)

The summary is quite self-explanatory. The top section shows details about the training sample, AIC, and other metrics. The middle section talks about the coefficients of the fitted mode. In case of ARIMA(1,1,1) for iteration 1, both AR and MA coefficients are statistically significant. The Forecast Plot for iteration 1 with ARIMA(1,1,1) fitted is shown in Figure 11-11.

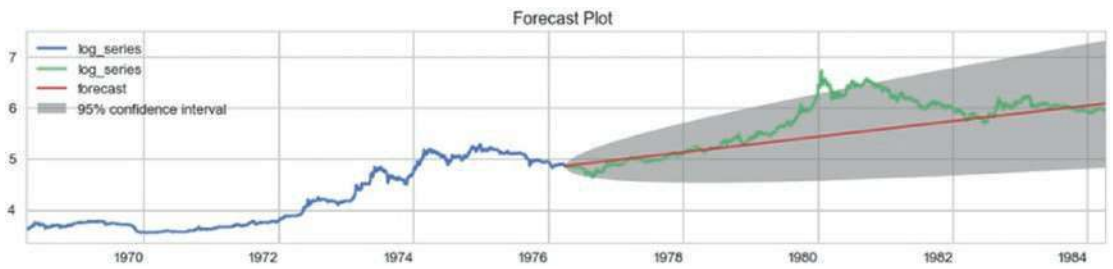

**Figure 11-11.** The forecast plot for  $ARIMA(1,1,1)$

As evident from the plot in Figure 11-11, the model captures the overall upward trend though it misses out on the sudden jump in values around 1980. Yet it seems to give a pretty nice idea of what can be achieved using this methodology. The `arima_gridsearch_cv()` function produces similar statistics and plots for five different train-test splits. We observe that  $ARIMA(1,1,1)$  provides us decent enough fit, although we can define additional performance and error criteria to select a particular model.

In this case, we generated forecast for time periods for which we already had data. This helps us in visualizing and understanding how the model is performing. This is also called as *back testing*. Out of sample forecasting is also supported by `statsmodels` through its `forecast()` method. Also, the plot in Figure 11-11 showcases values in the transformed scale, i.e. log scale. Inverse transformation can be easily applied to get data back in original form.

You should also note that commodity prices are impacted by a whole lot of other factors like global demand, economic conditions like recession and so on. Hence, what we showcased here was in certain ways a naïve modeling of a complex process. We would need more features and attributes to have sophisticated forecasts.

## Stock Price Prediction

Stocks and financial instrument trading is a lucrative proposition. Stock markets across the world facilitate such trades and thus wealth exchanges hands. Stock prices move up and down all the time and having ability to predict its movement has immense potential to make one rich.

Stock price prediction has kept people interested from a long time. There are hypothesis like the *Efficient Market Hypothesis*, which says that it is almost impossible to beat the market consistently and there are others which disagree with it.

There are a number of known approaches and new research going on to find the magic formula to make you rich. One of the traditional methods is the time series forecasting, which we saw in the previous section. *Fundamental analysis* is another method where numerous performance ratios are analyzed to assess a given stock. On the emerging front, there are *neural networks*, *genetic algorithms*, and *ensembling techniques*.

---

■ **Note** Stock price prediction (along with gold price prediction in the previous section) is an attempt to explain concepts and techniques to model real-world data and use cases. This chapter is by no means and extensive guide to algorithmic trading. *Algorithmic trading* is a complete field of study on its own and you may explore it further. Knowledge from this chapter alone would not be sufficient to perform trading of any sort and is beyond both the scope and intent of this book.

---

In this section, we learn how to apply *recurrent neural networks* (RNNs) to the problem of stock price prediction and understand the intricacies.

## Problem Statement

Stock price prediction is the task of forecasting the future value of a given stock. Given the historical daily close price for S&P 500 Index, prepare and compare forecasting solutions.

S&P 500 or *Standard and Poor's 500* index is an index comprising of 500 stocks from different sectors of US economy and is an indicator of US equities. Other such indices are the Dow 30, NIFTY 50, Nikkei 225, etc. For the purpose of understanding, we are utilizing S&P500 index, concepts, and knowledge can be applied to other stocks as well.

## Dataset

Similar to gold price dataset, the historical stock price information is also publicly available. For our current use case, we will utilize the `pandas_datareader` library to get the required S&P 500 index history using Yahoo Finance databases. We will utilize the *closing price* information from the dataset available though other information such as opening price, adjusted closing price, etc., are also available.

We prepare a utility function `get_raw_data()` to extract required information in a pandas dataframe. The function takes index ticker name as input. For S&P 500 index, the ticker name is `^GSPC`. The following snippet uses the utility function to get the required data.

```
In [1]: sp_df = get_raw_data('^GSPC')
...: sp_close_series = sp_df.Close
...: sp_close_series.plot()
```

The plot for closing price is depicted in Figure 11-12.

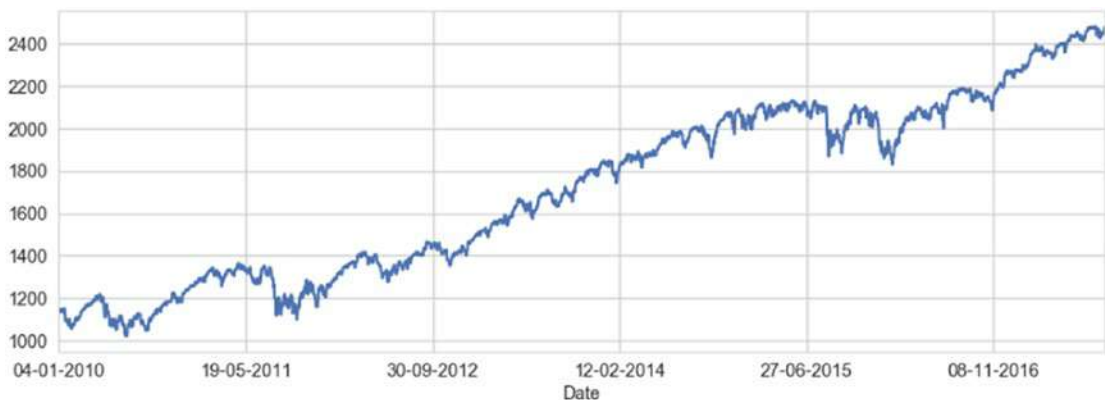

**Figure 11-12.** The S&P 500 index

The plot in Figure 11-12 shows that we have closing price information available since 2010 up until recently.

Kindly note that the same information is also available through `quandl` (which we used in the previous section to get gold price information). You may use the same to get this data as well.

## Recurrent Neural Networks: LSTM

Artificial neural networks are being employed to solve a number of use cases in a variety of domains.

Recurrent neural networks are a class of neural networks with capabilities of modeling sequential data.

LSTMs or *Long Short Term Memory* is an RNN architecture that's useful for modeling arbitrary intervals of information. RNNs, particularly LSTMs were discussed in Chapter 1 while a practical use case was explored in Chapter 7 for analyzing textual data from movie reviews for sentiment analysis.

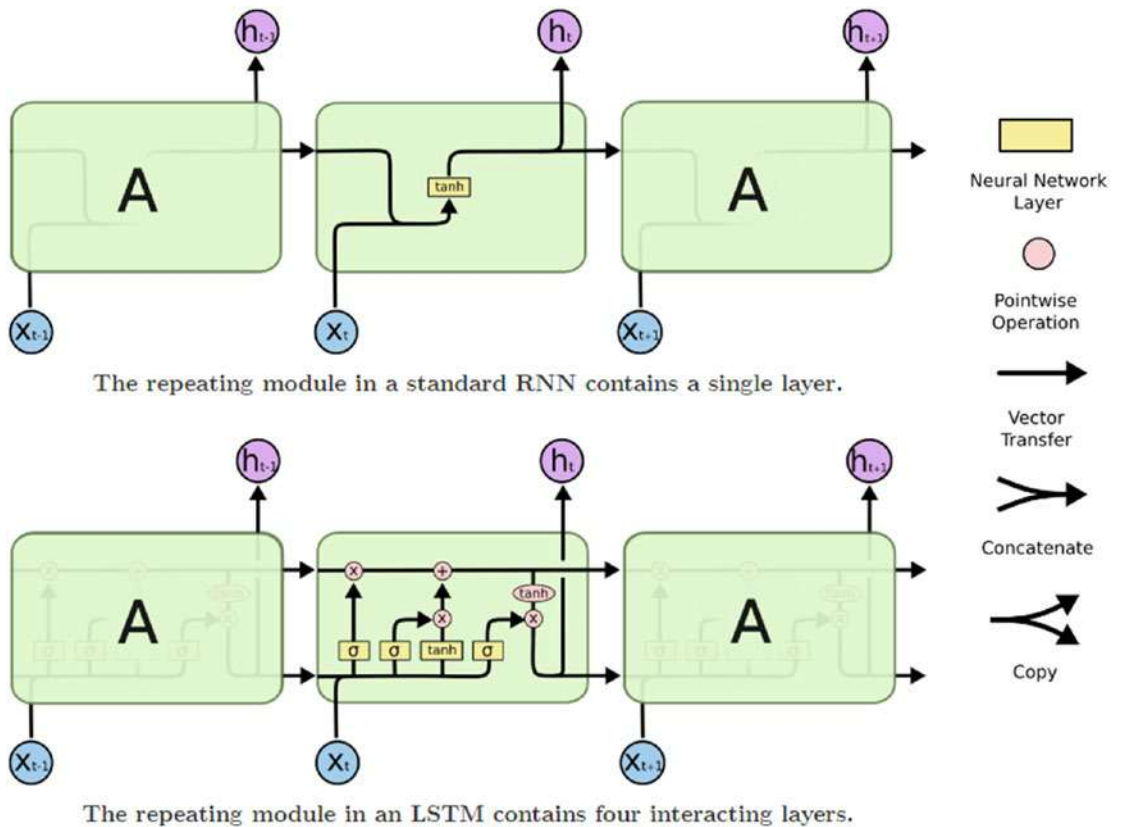

**Figure 11-13.** Basic structure of RNN and LSTM units. (Source: Christopher Olah's blog: [colah.github.io](http://colah.github.io))

As a quick refresher, Figure 11-13 points toward the general architecture of an RNN along with the internals of a typical LSTM unit. LSTM comprises of three major gates—the *input*, *output*, and *forget* gates. These gates work in tandem to learn and store long and short term sequence related information. For more details, refer to *Advanced Supervised Deep Learning Models*, Chapter 7.

For stock price prediction, we will utilize LSTM units to implement an RNN model. RNNs are typically useful in sequence modeling applications; some of them are as follows:

- **Sequence classification** tasks like sentiment analysis of a given corpus (see Chapter 7 for the detailed use case)
- **Sequence tagging** tasks like POS tagging a given sentence
- **Sequence mapping** tasks like speech recognition

Unlike traditional forecasting approaches (like ARIMA), which require preprocessing of time series information to conform to stationarity and other assumptions along with parameter identification ( $p, d, q$ , for instance), neural networks (particularly RNNs) impose far fewer restrictions.

Since stock price information is also a time series data, we will explore the application of LSTMs to this use case and generate forecasts. There are a number of ways this problem can be modeled to forecast values. The following sections covers two such approaches.

## Regression Modeling

We introduced regression modeling in Chapter 6 to analyze bike demand based on certain predictor variables. In essence, regression modeling refers to the process of investigating relationship between dependent and independent variables.

To model our current use case as a regression problem, we state that the stock price at timestamp  $t+1$  (dependent variable) is a function of stock price at timestamps  $t, t-1, t-2, \dots, t-n$ . Where  $n$  is the past window of stock prices.

Now that we have a framework defined on how we would model our time series, we need to transform our time series data into windowed form. See Figure 11-14.

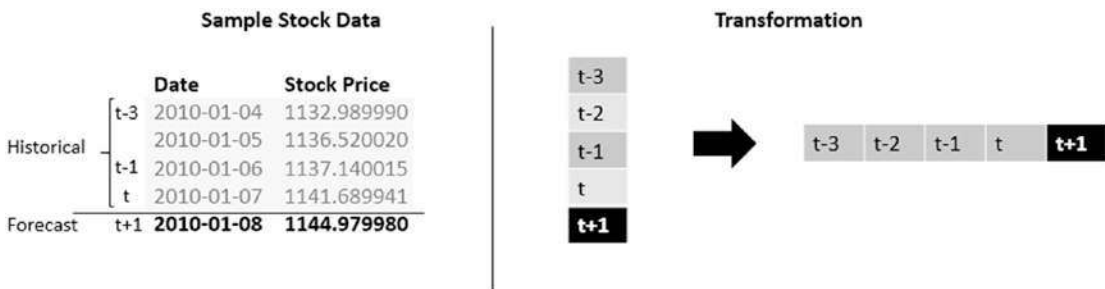

**Figure 11-14.** Transformation of stock price time series into windowed format

The windowed transformation is outlined in Figure 11-15 where a window size of 4 is used. The value at time  $t+1$  is forecasted using past four values. We have data for the S&P 500 index since 2010, hence we would apply this windowed transformation in a rolling fashion and create multiple such sequences. Thus, if we have a time series of length  $M$  and a window size of  $n$ , there would be  $M-n-1$  total windows generated.



**Figure 11-15.** Rolling/sliding windows from original time series

For the hands-on examples in this section, you can refer to the jupyter notebook `notebook_stock_prediction_regression_modeling_lstm.ipynb` for the necessary code snippets and examples. For using LSTMs to model our time series, we need to apply one more level of transformation to be able to input our data. LSTMs accept 3D tensors as input, we transform each of the windows (or sequences) in  $(N, W, F)$  format. Here,  $N$  is the *number of samples* or windows from the original time series,  $W$  is the *size of each window* or the number of historical time steps and  $F$  is the *number of features* per time step. In our case, as we are only using the closing price,  $F$  is equal to 1,  $N$  and  $W$  are configurable. The following function performs the windowing and 3D tensor transformations using pandas and numpy.

```
def get_reg_train_test(timeseries, sequence_length= 51,
                      train_size=0.9, roll_mean_window=5,
                      normalize=True, scale=False):
    # smoothen out series
    if roll_mean_window:
        timeseries = timeseries.rolling(roll_mean_window).mean().dropna()

    # create windows
    result = []
    for index in range(len(timeseries) - sequence_length):
        result.append(timeseries[index: index + sequence_length])

    # normalize data as a variation of 0th index
    if normalize:
        normalised_data = []
        for window in result:
            normalised_window = [((float(p) / float(window[0])) - 1) \
                                 for p in window]
            normalised_data.append(normalised_window)
        result = normalised_data

    # identify train-test splits
    result = np.array(result)
    row = round(train_size * result.shape[0])

    # split train and test sets
    train = result[:int(row), :]
    test = result[int(row):, :]
```

```

# scale data in 0-1 range
scaler = None
if scale:
    scaler=MinMaxScaler(feature_range=(0, 1))
    train = scaler.fit_transform(train)
    test = scaler.transform(test)

# split independent and dependent variables
x_train = train[:, :-1]
y_train = train[:, -1]

x_test = test[:, :-1]
y_test = test[:, -1]

# Transforms for LSTM input
x_train = np.reshape(x_train, (x_train.shape[0],
                               x_train.shape[1],
                               1))
x_test = np.reshape(x_test, (x_test.shape[0],
                              x_test.shape[1],
                              1))

return x_train,y_train,x_test,y_test,scaler

```

The function `get_reg_train_test()` also performs a number of other optional preprocessing steps. It allows us to *smoothen* the time series using rolling mean before the windowing is applied. We can also *normalize* the data as well as *scale* based on requirements. Neural networks are sensitive to input values and it is generally advised to *scale* inputs before training the network. For this use case, we will utilize the *normalization* of the time series wherein, for each window, every time step is the percentage change from the first value in that window (we could also use scaling or both and repeat the process).

For our case, we begin with a window size of six days (you can experiment with smaller or larger windows and observe the difference). The following snippet uses the `get_reg_train_test()` function with normalization set to true.

```

In [2] : WINDOW = 6
...: PRED_LENGTH = int(window/2)
...: x_train,y_train,x_test,y_test,scaler = get_reg_train_test(sp_close_series,
...:                                                         sequence_length=WINDOW +1,
...:                                                         roll_mean_window=None,
...:                                                         normalize=True,
...:                                                         scale=False)

```

This snippet creates a seven-day window that is comprised of six days of historical data (`x_train`) and one-day forecast `y_train`. The shapes of the train and test variables are as follows.

```

In [3] : print("x_train shape={}".format(x_train.shape))
...: print("y_train shape={}".format(y_train.shape))
...: print("x_test shape={}".format(x_test.shape))
...: print("y_test shape={}".format(y_test.shape))

```



```
x_train shape=(2516, 6, 1)
y_train shape=(2516,)
x_test shape=(280, 6, 1)
y_test shape=(280,)
```

The `x_train` and `x_test` tensors conform to the **(N, W, F)** format we discussed earlier and is required for input to our RNN. We have 2516 sequences in our training set, each with six time steps and one value to forecast. Similarly, we have 280 sequences in our test set.

Now that we have our datasets preprocessed and ready, we build up an RNN network using keras. The keras framework provides us high level abstractions to work with neural networks over theano and tensorflow backends. The following snippet showcases the model prepared using the `get_reg_model()` function.

```
In [4]: lstm_model = get_reg_model(layer_units=[50,100],
...:                               window_size=window)
```

The generated LSTM model architecture has two hidden LSTM layers stacked over each other with first one having 50 LSTM units and the second one having 100. The output layer is a Dense layer with linear activation function. We use *mean squared error* as our loss function to optimize upon. Since we are stacking LSTM layers, we need to set `return_sequences` to true in order for the subsequent layer to get the required values. As is evident, keras abstracts most of the heavy lifting and makes it pretty intuitive to build even complex architectures with just a few lines of code.

The next step is to train our LSTM network. We use batch size of 16 with 20 epochs and a validation set of 5%. The following snippet uses the `fit()` function to train the model.

```
In [5]: # use early stopping to avoid overfitting
...: callbacks = [keras.callbacks.EarlyStopping(monitor='val_loss',
...:                                           patience=2,
...:                                           verbose=0)]
...: lstm_model.fit(x_train, y_train,
...:                epochs=20, batch_size=16,
...:                verbose=1, validation_split=0.05,
...:                callbacks=callbacks)
```

The model generates information regarding training and validation loss for every epoch it runs. The callback for stopping enables us to stop the training if there is no further improvement observed for two consecutive epochs. We start with a batch size of 16; you may experiment with larger batch sizes and observe the difference.

Once the model is fit, the next step is to forecast using the `predict()` function. Since we have modeled this as a regression problem with a fixed window size, we would generate forecasts for every sequence. To do so, we write another utility function called `predict_reg_multiple()`. This function takes the *lstm* model, windowed dataset, window and prediction lengths as input parameters to return a list of predictions for every input window. The `predict_reg_multiple()` function works as follows.

1. For every sequence in the list of windowed sequences, repeat Steps a-c:
  - a. Use keras's `predict()` function to generate one output value.
  - b. Append this output value to the end of the input sequence and remove the first value to maintain the window size.
  - c. Then repeat this process (Steps a and b) until the required prediction length is achieved.
2. The function utilizes predicted values to forecast subsequent ones.

The function is available in the script `lstm_utils.py`. The following snippet uses the `predict_reg_multiple()` function to get predictions on the test set.

```
In [6] : test_pred_seqs = predict_reg_multiple(lstm_model,
...:                                       x_test,
...:                                       window_size=WINDOW,
...:                                       prediction_len=PRED_LENGTH)
```

To analyze the performance, we will calculate the RMSE for the fitted sequence. We use `sklearn`'s `metrics` module for the same. The following snippet calculates the RMSE score.

```
In [7] : test_rmse = math.sqrt(mean_squared_error(y_test[1:],
...:                                       np.array(test_pred_seqs).\
...:                                       flatten()))
...: print('Test Score: %.2f RMSE' % (test_rmse))
Test Score: 0.01 RMSE
```

The output is an RMSE of 0.01. As an exercise, you may compare RMSE with different window sizes and prediction lengths and observe the overall model performance.

To visualize our predictions, we plot the predictions against the normalized testing data. We use the function `plot_reg_results()`, which is also available for reference in `lstm_utils.py`. The following snippet generates the required plot using the same function.

```
In [8]: plot_reg_results(test_pred_seqs,y_test,prediction_len=PRED_LENGTH)
```

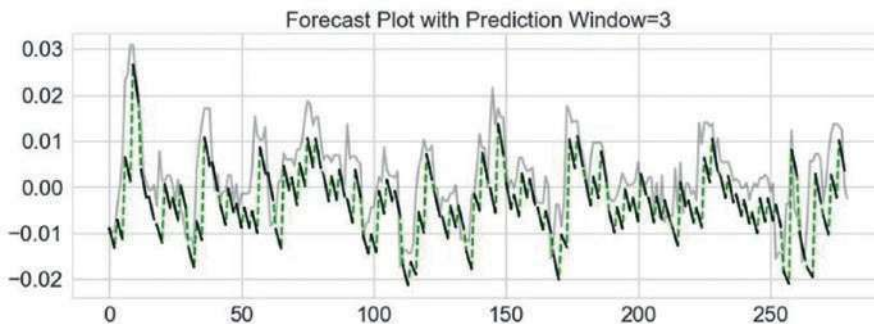

**Figure 11-16.** Forecast Plot with LSTM, window size 6 and prediction length 3

In Figure 11-16, the gray line is the original/true test data (normalized) and the black lines denote the predicted/forecast values in three-day periods. The dotted line is used to explain the overall flow of the predicted series. As is evident, the forecasts are off the mark to some extent from the actual data trends yet they seem to have some similarity to the actual data.

Before we conclude this section, there are a few important points to be kept in mind. LSTMs are vastly powerful units with memory to store and use past information. In our current scenario, we utilized a windowed approach with a stacked LSTM architecture (two LSTM layers in our model). This is also termed as *many-to-one* architecture where multiple input values are used to generate single output. Another important point here is that the window size along with other hyperparameters of the network (like epochs, batch size, LSTM units, etc.) have an impact on the final results (this is left as an exercise for you to explore). Thus, we should be careful before deploying such models in production.

## Sequence Modeling

In the previous section we modeled our time series like a regression use case. In essence, the problem formulation though utilized past window to forecast, it did not use the time step information. In this section, we will solve the same stock prediction problem using LSTMs by modeling it as a sequence. For the hands-on examples in this section, you can refer to the jupyter notebook `notebook_stock_prediction_sequence_modeling_lstm.ipynb` for the necessary code snippets and examples.

Recurrent neural networks are naturally suited for sequence modeling tasks like machine translation, speech recognition and so on. RNNs utilize memory (unlike normal feed forward neural networks) to keep track of context and utilize the same to generate outputs. In general feed forward neural networks assume inputs are independent of each other. This independence may not hold in many scenarios (such as time series data). RNNs apply same transformations to each element of the sequence, with outcomes being dependent upon previous values.

In case of our stock price time series, we would like to model it now as sequence where value at each time step is a function of previous values. Unlike the regression-like modeling, here we do not divide the time series into windows of fixed sizes, rather we would utilize the LSTMs to learn from the data and determine which past values to utilize for forecasting.

To do so, we need to perform certain tweaks to the way we processed our data in the previous case and also how we built our RNN. In the previous section, we utilized the **(N,W,F)** format as input. In the current setting, the format remain the same with the following changes.

- **N (number of sequences)**: This will be set to 1 since we are dealing with only one stock's price information.
- **W (length of sequence)**: This will be set to total number of days worth of price information we have with us. Here we use the whole series as one big sequence.
- **F (features per timestamp)**: This is again 1, as we are only dealing with closing stock value per timestamp.

Talking about the output, in the previous section we had one output for every window/sequence in consideration. While modeling our data as a sequence/time series we expect our output to be a sequence as well. Thus, the output is also a 3D tensor following the same format as the input tensor.

We write a small utility function `get_seq_train_test()` to help us scale and generate train and test datasets out of our time series. We use a 70-30 split in this case. We then use `numpy` to reshape our time series into 3D tensors. The following snippet utilizes the `get_seq_train_test()` function to do the same.

```
In [1]: train,test,scaler = get_seq_train_test(sp_close_series,
...:                                       scaling=True,
...:                                       train_size=TRAIN_PERCENT)
...:
...: train = np.reshape(train,(1,train.shape[0],1))
...: test = np.reshape(test,(1,test.shape[0],1))
...:
...: train_x = train[:, :-1, :]
...: train_y = train[:, 1:, :]
...:
...: test_x = test[:, :-1, :]
...: test_y = test[:, 1:, :]
...:
...: print("Data Split Complete")
...:
...: print("train_x shape={}".format(train_x.shape))
```

```

...: print("train_y shape={}".format(train_y.shape))
...: print("test_x shape={}".format(test_x.shape))
...: print("test_y shape={}".format(test_y.shape))
Data Split Complete
train_x shape=(1, 1964, 1)
train_y shape=(1, 1964, 1)
test_x shape=(1, 842, 1)
test_y shape=(1, 842, 1)

```

Having prepared the datasets, let we'll now move onto setting up the RNN network. Since we are planning on generating a sequence as output as opposed to a single output in the previous case, we need to tweak our network architecture.

The requirement in this case is to apply similar transformations/processing for every time step and be able to get output for every input timestamp rather than waiting for the whole sequence to be processed. To enable such scenarios, keras provides a wrapper over dense layers called `TimeDistributed`. This wrapper applies the same task to every time step and provides hooks to get output after each such time step. We use `TimeDistributed` wrapper over `Dense` layer to get output from each of the time steps being processed. The following snippet showcases `get_seq_model()` function to generate the required model.

```

def get_seq_model(hidden_units=4,input_shape=(1,1),verbose=False):
    # create and fit the LSTM network
    model = Sequential()

    # input shape = timesteps*features
    model.add(LSTM(input_shape=input_shape,
                  units = hidden_units,
                  return_sequences=True
                ))

    # TimeDistributedDense uses the processing for all time steps.
    model.add(TimeDistributed(Dense(1)))
    start = time.time()

    model.compile(loss="mse", optimizer="rmsprop")

    if verbose:
        print("> Compilation Time : ", time.time() - start)
        print(model.summary())

    return model

```

This function returns a single hidden layer RNN network with four LSTM units and a `TimeDistributed` Dense output layer. We again use *mean squared error* as our loss function.

---

■ **Note** `TimeDistributed` is a powerful yet tricky utility available through keras. You may explore more on this at <https://github.com/fchollet/keras/issues/1029> and <https://datascience.stackexchange.com/questions/10836/the-difference-between-dense-and-timedistributeddense-of-keras>.

---

We have our dataset preprocessed and split into train and test along with a model object using the function `get_seq_model()`. The next step is to simply train the model using the `fit()` function. While modeling stock price information as a sequence, we are assuming the whole time series as one big sequence. Hence, while training the model, we set the batch size as 1 as there is only one stock to train in this case. The following snippet gets the model object and then trains the same using the `fit()` function.

```
In [2]: # get the model
...: seq_lstm_model = get_seq_model(input_shape=(train_x.shape[1],1),
...:                               verbose=VERBOSE)
...:
...: # train the model
...: seq_lstm_model.fit(train_x, train_y,
...:                   epochs=150, batch_size=1,
...:                   verbose=2)
```

This snippet returns a model object along with its summary. We also see the output of each of the 150 epochs while the model trains on the training data.

Layer (type)	Output Shape	Param #
lstm_2 (LSTM)	(None, 1964, 4)	96
time_distributed_1 (TimeDist)	(None, 1964, 1)	5
Total params: 101		
Trainable params: 101		
Non-trainable params: 0		
None		

**Figure 11-17.** RNN Summary

Figure 11-17 shows the total parameters which the RNN tries to learn, a complete 101 of them. We urge you to explore the summary on the model prepared in the previous section, the results should surprise most (Hint: this model has far few parameters to learn!). This summary also points toward an important fact, the shape of the first LSTM layer. This clearly shows that the model expects the inputs to adhere to this shape (the shape of the training dataset) for training as well as predicting.

Since our test dataset is smaller (shape:  $(1, 842, 1)$ ), we need some way to match the required shape. While modeling sequences with RNNs, it is a common practice to pad sequences in order to match a given shape. Usually in cases where there are multiple sequences to train upon (example, text generation), the size of the longest sequence is used and the shorter ones are padded to match it. We do so only for programmatic reasons and discard the padded values otherwise (see keras masking for more on this). The padding utility is available from the `keras.preprocessing.sequence` module. The following snippet pads the test dataset with 0s post the actual data (you can choose between pre-pad and post pad) and then uses the padded sequence to predict/forecast. We also calculate and print the RMSE score of the forecast.

```
In [3]: # Pad input sequence
...: testPredict = pad_sequences(test_x,
...:                             maxlen=train_x.shape[1],
...:                             padding='post',
...:                             dtype='float64')
```

```

...:
...: # forecast values
...: testPredict = seq_lstm_model.predict(testPredict)
...:
...: # evaluate performance
...: testScore = math.sqrt(mean_squared_error(test_y[0],
...:                                         testPredict[0][:test_x.shape[1]]))
...: print('Test Score: %.2f RMSE' % (testScore))
Test Score: 0.07 RMSE

```

We can perform the same steps on the training set as well and check the performance. While generating the train and test datasets, the function `get_seq_train_test()` also returned the scaler object. We next use this scaler object to perform an inverse transformation to get the prediction values in the original scale. The following snippet performs inverse transformation and then plots the series.

```

In [4]: # inverse transformation
...: trainPredict = scaler.inverse_transform(trainPredict.\
...:                                       reshape(trainPredict.shape[1]))
...: testPredict = scaler.inverse_transform(testPredict.\
...:                                       reshape(testPredict.shape[1]))
...:
...: train_size = len(trainPredict)+1
...:
...: # plot the true and forecasted values
...: plt.plot(sp_close_series.index,
...:          sp_close_series.values,c='black',
...:          alpha=0.3,label='True Data')
...:
...: plt.plot(sp_close_series.index[1:train_size],
...:          trainPredict,
...:          label='Training Fit',c='g')
...:
...: plt.plot(sp_close_series.index[train_size+1:],
...:          testPredict[:test_x.shape[1]],
...:          label='Forecast')
...: plt.title('Forecast Plot')
...: plt.legend()
...: plt.show()

```

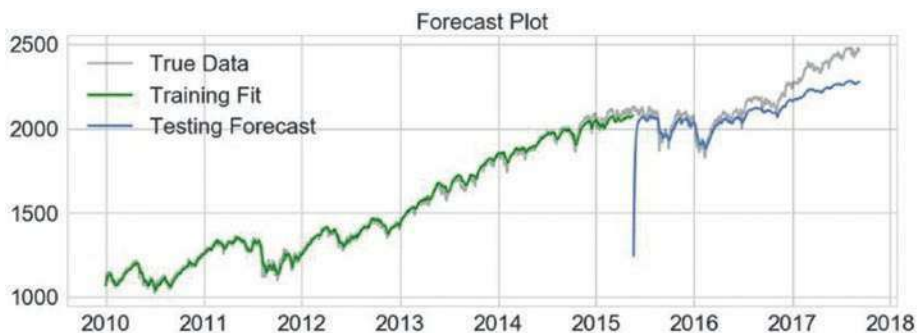

**Figure 11-18.** Forecast for S&P 500 using LSTM based sequence modeling

The forecast plot in Figure 11-18 shows a promising picture. We can see that the training fit is nearly perfect which is kind of expected. The testing performance or the forecast also shows decent performance. Even though the forecast deviates from the actual at places, the overall performance both in terms of RMSE and the fit seemed to have worked.

Through the use of `TimeDistributed` layer wrapper we achieved the goal of modeling this data as a time series. The model not just had a better performance in terms of overall fit, it required far less feature engineering and a much simpler model (in terms of number of training parameters). In this model, we also truly utilized the power of LSTMs by allowing it to learn and figure out what and how much of past information impacts the forecast (as compared to regression modeling case where we had restricted the window sizes).

Two important points before we conclude this section. First, both the models have their own advantages and disadvantages. The aim of this section was to chalk out potential ways of modeling a given problem. The actual usage mostly depends upon the requirements of the use case. Secondly and more importantly, either of the models is for learning/demonstration purposes. Actual stock price forecasting requires far more rigor and knowledge; we just scraped the tip of the iceberg.

## Upcoming Techniques: Prophet

The Data Science landscape is ever evolving and new algorithms, tweaks and tools are coming up at a rapid pace. One such tool is called Prophet. This is a framework, open sourced by Facebook's Data Science team for analyzing and forecasting time series.

Prophet uses an additive model that can work with trending and seasonal data. The aim of this tool is to enable forecasting at scale. This is still in beta, yet has some really useful features. More on this is available at <https://facebookincubator.github.io/prophet/>. The research and intuition behind this tool is available in the paper available at [https://facebookincubator.github.io/prophet/static/prophet\\_paper\\_20170113.pdf](https://facebookincubator.github.io/prophet/static/prophet_paper_20170113.pdf).

The installation steps are outlined on the web site and are straightforward through pip and conda. Prophet also uses scikit style APIs of `fit()` and `predict()` with additional utilities to better handle time series data. For the hands-on examples in this section, you can refer to the jupyter notebook `notebook_stock_prediction_fbprophet.ipynb` for the necessary code snippets and examples.

---

■ **Note** Prophet is still in beta and is undergoing changes. Also, its installation on Windows platform is known to cause issues. Kindly use `conda install` (steps mentioned on the web site) with Anaconda distribution to avoid issues.

---

Since we already have the S&P 500 index price information available in a dataframe/series. We now test how we can use this tool to forecast. We begin with converting the time series index into a column of its own (simply how prophet expects the data) followed by splitting the series into training and testing (90-10 split). The following snippet performs the required actions.

```
In [1] : # reset index to get date_time as a column
...: prophet_df = sp_df.reset_index()
...:
...: # prepare the required dataframe
...: prophet_df.rename(columns={'index':'ds','Close':'y'},inplace=True)
...: prophet_df = prophet_df[['ds','y']]
...:
```

```

...: # prepare train and test sets
...: train_size = int(prophet_df.shape[0]*0.9)
...: train_df = prophet_df.ix[:train_size]
...: test_df = prophet_df.ix[train_size+1:]

```

Once we have the datasets prepared, we create an object of the Prophet class and simply fit the model using fit() function. Kindly note that the model expects the time series value to be in a column named 'y' and timestamp in column named 'ds'. To make forecasts, prophet requires the set of dates for which we need to forecast. For this, it provides a clean utility called the make\_future\_dataframe(), which takes the number of days required for the forecast as input. The following snippet uses this dataframe to forecast values.

```

In [2] : # prepare a future dataframe
...: test_dates = pro_model.make_future_dataframe(
...:         periods=test_df.shape[0])
...:
...: # forecast values
...: forecast_df = pro_model.predict(test_dates)

```

The output from the predict() function is a dataframe that includes both in-sample predictions as well as forecasted values. The dataframe also includes the confidence interval values. All of this can be easily plotted using the plot() function of the model object. The following snippet plots the forecasted values against the original time series along with its confidence intervals.

```

In [3] : # plot against true data
...: plt.plot(forecast_df.yhat,c='r',label='Forecast')
...: plt.plot(forecast_df.yhat_lower.iloc[train_size+1:],
...:         linestyle='--',c='b',alpha=0.3,
...:         label='Confidence Interval')
...: plt.plot(forecast_df.yhat_upper.iloc[train_size+1:],
...:         linestyle='--',c='b',alpha=0.3,
...:         label='Confidence Interval')
...: plt.plot(prophet_df.y,c='g',label='True Data')
...: plt.legend()
...: plt.title('Prophet Model Forecast Against True Data')
...: plt.show()

```

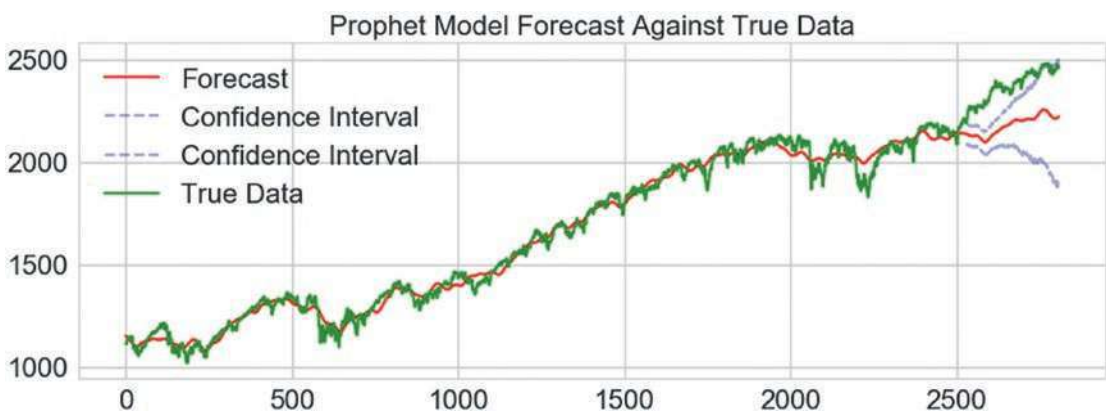

**Figure 11-19.** Forecasts from prophet against true/observed values



The model's forecasts are a bit off the mark (see Figure 11-19), but the exercise clearly demonstrates the possibilities here. The forecast dataframe provides even more details about seasonality, weekly trends, and so on. You are encouraged to explore this further. Prophet is based upon *Stan*. *Stan* is statistical modeling language/framework that provides algorithms exposed through interfaces for all major languages, including python. You may explore more on this at <http://mc-stan.org/>.

## Summary

This chapter introduced the concepts of time series forecasting and analysis using stock and commodity price information. Through this chapter we covered the basic components of a time series along with common techniques for preprocessing such data. We then worked on the gold price prediction use case. This use case utilized the `quandl` library to get daily gold price information. We then discussed traditional time series analysis techniques and introduced key concepts related to Box-Jenkin's methodology and ARIMA in particular. We also discussed techniques for identification and transformation of non-stationary time series into one using AD Fuller tests, ACF and PACF plots. We modeled the gold price information using ARIMA based on `statsmodel` APIs while developing some key utility functions like `auto_arima()` and `arima_gridsearch_cv()`. Key insights and caveats were also discussed. The next section of the chapter introduced the stock price prediction use case. Here, we utilized `pandas_datareader` to get S&P 500 daily closing price information.

To solve this use case, we utilized RNN based models. Primarily we provided two alternative perspectives of formulating the forecasting problem, both using LSTMs. The first formulation closely imitated the regression concepts discussed in earlier chapters. A two-layer stacked LSTM network was used to forecast stock price information. The second perspective utilized `TimeDistributed` layer wrapper from `keras` to enable sequence modeling of the stock price information. Various utilities and key concepts were discussed while working on the use case. Finally, an upcoming tool (still in beta), Prophet from Facebook was discussed. The tool is made available by Facebook's Data Science team to perform forecasting at scale. We utilized the framework to quickly evaluate its performance on the same stock price information and shared the results. A multitude of techniques and concepts were introduced in this chapter, along with the intuition on how to formulate certain time series problems. Stay tuned for some more exciting use cases in the next chapter.

## CHAPTER 12



# Deep Learning for Computer Vision

Deep Learning is not just a keyword abuzz in the industry and academics, it has thrown wide open a whole new field of possibilities. Deep Learning models are being employed in all sorts of use cases and domains, some of which we saw in the previous chapters. Deep neural networks have tremendous potential to learn complex non-linear functions, patterns, and representations. Their power is driving research in multiple fields, including computer vision, audio-visual analysis, chatbots and natural language understanding, to name a few. In this chapter, we touch on some of the advanced areas in the field of computer vision, which have recently come into prominence with the advent of Deep Learning. This includes real-world applications like image categorization and classification and the very popular concept of image artistic style transfer. Computer vision is all about the art and science of making machines understand high-level useful patterns and representations from images and videos so that it would be able to make intelligent decisions similar to what a human would do upon observing its surroundings. Building on core concepts like convolutional neural networks and transfer learning, this chapter provides you with a glimpse into the forefront of Deep Learning research with several real-world case studies from computer vision.

This chapter discusses convolutional neural networks through the task of image classification using publicly available datasets like CIFAR, ImageNet, and MNIST. We will utilize our understanding of CNNs to then take on the task of style transfer and understand how neural networks can be used to understand high-level features. Through this chapter, we cover the following topics in detail:

- Brief overview of convolutional neural networks
- Image classification using CNNs from scratch
- Transfer learning: image classification using pretrained models
- Neural style transfer using CNNs

The code samples, jupyter notebooks, and sample datasets for this chapter are available in the GitHub repository for this book at <https://github.com/dipanjanS/practical-machine-learning-with-python> under the directory/folder for Chapter 12.

## Convolutional Neural Networks

Convolutional Neural Networks (CNNs) are similar to the general neural networks we have discussed over the course of this book. The additional explicit assumption of input being an image (tensor) is what makes CNNs optimized and different than the usual neural networks. This explicit assumption is what allows us to design deep CNNs while keeping the number of trainable parameters in check (in comparison to general neural networks).

We touched upon the concepts of CNNs in Chapter 1 (in the section “Deep Learning”) and Chapter 4 (in the section :Feature Engineering on Image Data). However, as a quick refresher, the following are the key concepts worth reiterating:

- **Convolutional Layer:** This is the key differentiating component of a CNN as compared to other neural networks. Convolutional layer or conv layer is a set of learnable filters. These filters help capture spatial features. These are usually small (along the width and height) but cover the full depth (color range) of the image. During the forward pass, we slide the filter across the width and the height of the image while computing the dot product between the filter attributes and the input at any position. The output is a two-dimensional activation map from each filter, which are then stacked to get the final output.
- **Pooling Layer:** These are basically down-sampling layers used to reduce spatial size and number of parameters. These layers also help in controlling overfitting. Pooling layers are inserted in between conv layers. Pooling layers can perform down sampling using functions such as max, average, L2-norm, and so on.
- **Fully Connected Layer:** Also known as FC layer. These are similar to fully connected layers in general neural networks. These have full connections to all neurons in the previous layer. This layer helps perform the tasks of classification.
- **Parameter Sharing:** The unique thing about CNNs apart from the conv layer is parameter sharing. Conv layers use same set of weights across the filters thus reducing the overall number of parameters required.

A typical CNN architecture with all the components is depicted in Figure 12-1, which is a LeNet CNN model (Source: deeplearning.net).

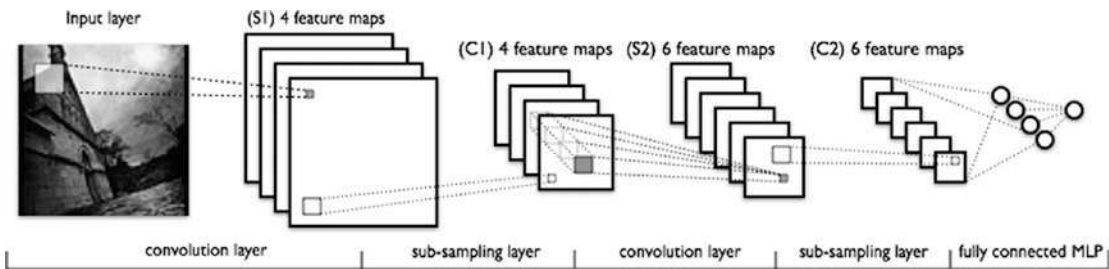

**Figure 12-1.** LeNet CNN model (source: deeplearning.net)

CNNs have been studied in-depth and are being constantly improved and experimented with. For an in-depth understanding of CNNs, refer to courses such as one from Stanford available at <http://cs231n.github.io/convolutional-networks>.

# Image Classification with CNNs

Convolutional Neural Networks are prime examples of the potential and power of neural networks to learn detailed feature representations and patterns from images and perform complex tasks, ranging from object recognition to image classification and many more. CNNs have gone through tremendous research and advancements have led to more complex and power architectures, like VGG-16, VGG-19, Inception V3, and many more interesting models.

We begin with a getting some hands-on experience with CNNs by working on an image classification problem. We shared an example of CNN based classification in Chapter 4 through the notebook, Bonus - Classifying handwritten digits using Deep CNNs.ipynb, which talks about classifying and predicting human handwritten digits by leveraging CNN based Deep Learning. In case you haven't gone through it, do not worry as we will go through a detailed example here. For our Deep Learning needs, we will be utilizing the keras framework with the tensorflow backend, similar to what we used in the previous chapters.

## Problem Statement

Given a set of images containing real-world objects, it is fairly easy for humans to recognize them. Our task here is to build a multiclass (10 classes or categories) image classifier that can identify the correct class label of a given image. For this task, we will be utilizing the CIFAR10 dataset.

## Dataset

The CIFAR10 dataset is a collection of tiny labeled images spanning across 10 different classes. The dataset was collected by Alex Krizhevsky, Vinod Nair, and Geoffrey Hinton and is available at <https://www.cs.toronto.edu/~kriz/cifar.html> as well as through the datasets module in keras.

This dataset contains tiny images of size 32 x 32 with 50,000 training and 10,000 test samples. Each image can fall into one and only one of the following classes.

- Automobile
- Airplane
- Bird
- Cat
- Deer
- Dog
- Frog
- Horse
- Ship
- Truck

Each class is mutually exclusive. There is another larger version of the dataset called the CIFAR100. For the purpose of this section, we will consider the CIFAR10 dataset.

We would be accessing the CIFAR10 dataset through the `keras.datasets` module. Download the required files if they are not already present.

## CNN Based Deep Learning Classifier from Scratch

Similar to any Machine Learning algorithm, neural networks also require the input data to be certain shape, size, and type. So, before we reach the modeling step, the first thing is to preprocess the data itself. The following snippet gets the dataset and then performs one hot encoding of the labels. Remember there are 10 classes to work with and hence we are dealing with a multi-class classification problem.

```
In [1]: import keras
...: from keras.datasets import cifar10
...:
...: num_classes = 10
...:
...: (x_train, y_train), (x_test, y_test) = cifar10.load_data()
...:
...: # convert class vectors to binary class matrices
...: y_train = keras.utils.to_categorical(y_train, num_classes)
...: y_test = keras.utils.to_categorical(y_test, num_classes)
```

The dataset, if not already present locally, would be downloaded automatically. The following are the shapes of the objects obtained.

```
In [2]: print('x_train shape:', x_train.shape)
...: print(x_train.shape[0], 'train samples')
...: print(x_test.shape[0], 'test samples')
...:
x_train shape: (50000, 32, 32, 3)
50000 train samples
10000 test samples
```

Now that we have training and test datasets. The next step is to build the CNN model. Since we have two dimensional images (the third dimension is the channel information), we will be using Conv2D layers. As discussed in the previous section, CNNs uses a combination of convolutional layers and pooling layers followed by a fully connected end to identify/classify the data. The model architecture is built as follows.

```
In [3]: model = Sequential()
...: model.add(Conv2D(32, kernel_size=(3, 3),
...:                 activation='relu',
...:                 input_shape=input_shape))
...: model.add(Conv2D(64, (3, 3), activation='relu'))
...: model.add(MaxPooling2D(pool_size=(2, 2)))
...: model.add(Dropout(0.25))
...: model.add(Flatten())
...: model.add(Dense(128, activation='relu'))
...: model.add(Dropout(0.5))
...: model.add(Dense(num_classes, activation='softmax'))
```

It starts off with a convolutional layer with a total of 32 3 x 3 filters and activation function as the rectified linear unit (relu). The input shape resembles each image size, i.e. 32 x 32 x 3 (color image has three channels—RGB). This is followed by another convolutional layer and a *max-pooling* layer. Finally, we have the fully connected *dense layer*. Since we have 10 classes to choose from, the final output layer has a softmax activation.

The next step involves compiling. We use `categorical_crossentropy` as our loss function since we are dealing with multiple classes. Besides this, we use the Adadelta optimizer and then train the classifier on the training data. The following snippet showcases the same.

```
In [4]: model.compile(loss=keras.losses.categorical_crossentropy,
...:                  optimizer=keras.optimizers.Adadelta(),
...:                  metrics=['accuracy'])
...:
...: model.fit(x_train, y_train,
...:          batch_size=batch_size,
...:          epochs=epochs,
...:          verbose=1)
Epoch 1/10
50000/50000 [=====] - 256s - loss: 7.3118 - acc: 0.1798
Epoch 2/10
50000/50000 [=====] - 250s - loss: 1.7923 - acc: 0.3564
Epoch 3/10
50000/50000 [=====] - 252s - loss: 1.5781 - acc: 0.4383
...
Epoch 9/10
50000/50000 [=====] - 251s - loss: 1.1019 - acc: 0.6163
Epoch 10/10
50000/50000 [=====] - 254s - loss: 1.0584 - acc: 0.6284
```

From the preceding output, it is clear that we trained the model for 10 epochs. This takes anywhere between 200-400 secs on a CPU, the performance improves manifold when done using a GPU. We can see the accuracy is around 63% based on the last epoch. We will now evaluate the testing performance, this is checked using the `evaluate` function of the model object. The results are as follows.

```
Test loss: 1.10143025074
Test accuracy: 0.6354
```

Thus, we can see that our very simple CNN based Deep Learning model achieved an accuracy of 63.5%, given the fact that we have built a very simple model and that we haven't done much preprocessing or model tuning. You are encouraged to try different CNN architectures and experiment with hyperparameter tuning to see how the results can be improved.

The initial few conv layers of the model kind of work toward feature extraction while the last couple of layers (fully connected) help in classifying the data. Thus, it would be interesting to see how the image data is manipulated by the conv-net we just created. Luckily, keras provides hooks to extract information at intermediate steps in the model. They depict how various regions of the image activate the conv layers and how the corresponding feature representations and patterns are extracted.

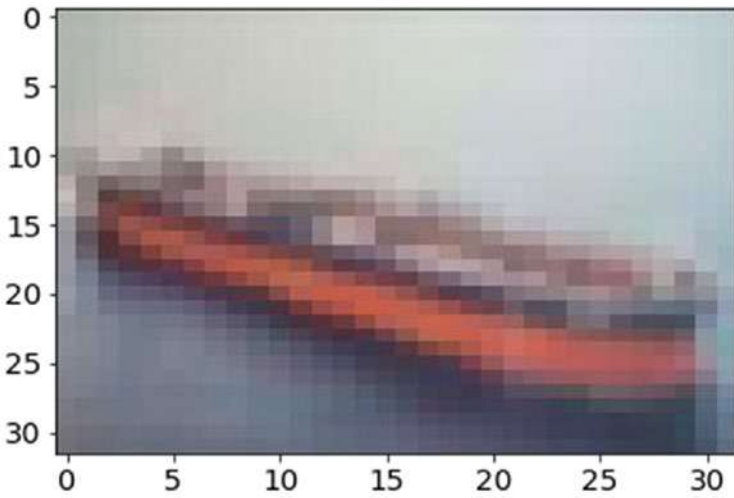

**Figure 12-2.** Sample image from the CIFAR10 dataset

A sample flow of how an image is viewed by the CNN is explained in the notebook `notebook_cnn_cifar10_classifier.ipynb`. It contains rest of the code discussed in this section. Figure 12-2 shows an image from the test dataset. It looks like a ship and the model correctly identifies the same as well as depicted in this snippet.

```
# actual image id
img_idx = 999
# actual image label
In [5]: y_test[img_idx]
array([ 0.,  0.,  0.,  0.,  0.,  0.,  0.,  0.,  1.,  0.])

# predict label with our model
In [6]: test_image = np.expand_dims(x_test[img_idx], axis=0)
...: model.predict_classes(test_image, batch_size=1)
1/1 [=====] - 0s
Out[16]:
array([8], dtype=int64)
```

You can extract and view the activation maps of the image based on what representations are learned and extracted by the conv layers using the `get_activations(...)` and `display_activations(...)` functions in the notebook. Figure 12-3 shows the activations of initial conv layers of the CNN model we just built.



**Figure 12-3.** Sample image through a CNN layer

We also recommend you go through the section “Automated Feature Engineering with Deep Learning” in Chapter 4 to learn more about extracting feature representations from images using convolutional layers.

## CNN Based Deep Learning Classifier with Pretrained Models

Building a classifier from scratch has its own set of pros and cons. Yet, a more refined approach is to leverage pre-trained models over large complex datasets. There are many famous CNN architectures like LeNet, ResNet, VGG-16, VGG-19, and so on. These models have deep and complex architectures that have been fine-tuned and trained over diverse, large datasets. Hence, these models have been proven to have amazing performance on complex object recognition tasks.

Since obtaining large labeled datasets and training highly complex and deep neural networks is a time-consuming task (*training a complex CNN like VGG-19 could take a few weeks, even using GPUs*). In practice, we utilize a concept, what is formally termed as *transfer learning*. This concept of transfer learning helps us leverage existing models for our tasks. The core idea is to leverage the *learning*, which the model learned from being trained over a large dataset and then *transfer* this learning by re-using the same model to extract feature representations from new images. There are several strategies of performing transfer learning, some of which are mentioned as follows:

- **Pre-trained model as feature extractor:** The pre-trained model is used to extract features for our dataset. We build a fully connected classifier on top of these features. In this case we only need to train the fully connected classifier, which does not take much time.
- **Fine-tuning pre-trained models:** It is possible to fine-tune an existing pre-trained model by fixing some of the layers and allowing others to learn/update weights apart from the fully connected layers. Usually it is observed that initial layers capture generic features while the deeper ones become more specific in terms of feature extraction. Thus, depending upon the requirements, we fix certain layers and fine-tune the rest.

In this section, we see an example where we will utilize a pre-trained conv-network as a feature extractor and build fully connected layer based classifier on top of it and train the model. We will not train the feature extraction layers and hence leverage principles of transfer learning by using the pre-trained conv layers for feature extraction.

The VGG-19 model from the Visual Geometry Group of the Oxford University is one state-of-the-art convolutional neural network. This has been shown to perform extremely well on various benchmarks and competitions. VGG19 is a 19-layer conv-net trained on ImageNet dataset. ImageNet is visual database of hand-annotated images amounting to 10 million spanning across 9,000+ categories. This model has been widely studied and used in tasks such as transfer learning.

---

■ **Note** More details on this and other research by the VGG group is available at [http://www.robots.ox.ac.uk/~vgg/research/very\\_deep/](http://www.robots.ox.ac.uk/~vgg/research/very_deep/).

---

This pretrained model is available through the `keras.applications` module. As mentioned, we will utilize VGG-19 to act as feature extractor to help us build a classifier on CIFAR10 dataset.

Since we would be using VGG-19 for feature extraction, we do not need the top (or fully connected) layers of this model. `keras` makes this as simple as setting a single flag value to `False`. The following snippet loads the VGG-19 model architecture consisting of the conv layers and leaves out the fully connected layers.



```
In [1]: from keras import applications
...:
...: vgg_model = applications.VGG19(include_top=False, weights='imagenet')
```

Now that the pre-trained model is available, we will utilize it to extract features from our training dataset. Remember VGG-19 is trained upon ImageNet while we would be using CIFAR10 to build a classifier. Since ImageNet contains over 10 million images spanning across 9,000+ categories, it is safe to assume that CIFAR10's categories would be a subset here. Before moving on to feature extraction using the VGG-19 model, it would be a good idea to check out the model's architecture.

```
In [1]: vgg_model.summary()
```

Layer (type)	Output Shape	Param #
input_1 (InputLayer)	(None, None, None, 3)	0
block1_conv1 (Conv2D)	(None, None, None, 64)	1792
block1_conv2 (Conv2D)	(None, None, None, 64)	36928
block1_pool (MaxPooling2D)	(None, None, None, 64)	0
block2_conv1 (Conv2D)	(None, None, None, 128)	73856
block2_conv2 (Conv2D)	(None, None, None, 128)	147584
block2_pool (MaxPooling2D)	(None, None, None, 128)	0
block3_conv1 (Conv2D)	(None, None, None, 256)	295168
block3_conv2 (Conv2D)	(None, None, None, 256)	590080
block3_conv3 (Conv2D)	(None, None, None, 256)	590080
block3_conv4 (Conv2D)	(None, None, None, 256)	590080
block3_pool (MaxPooling2D)	(None, None, None, 256)	0
block4_conv1 (Conv2D)	(None, None, None, 512)	1180160
block4_conv2 (Conv2D)	(None, None, None, 512)	2359808
block4_conv3 (Conv2D)	(None, None, None, 512)	2359808
block4_conv4 (Conv2D)	(None, None, None, 512)	2359808
block4_pool (MaxPooling2D)	(None, None, None, 512)	0
block5_conv1 (Conv2D)	(None, None, None, 512)	2359808
block5_conv2 (Conv2D)	(None, None, None, 512)	2359808

block5_conv3 (Conv2D)	(None, None, None, 512)	2359808
block5_conv4 (Conv2D)	(None, None, None, 512)	2359808
block5_pool (MaxPooling2D)	(None, None, None, 512)	0
=====		
Total params: 20,024,384		
Trainable params: 20,024,384		
Non-trainable params: 0		

From the preceding output, you can see that the architecture is huge with a lot of layers. Figure 12-4 depicts the same in an easier-to-understand visual depicting all the layers. Remember that we do not use the fully connected layers depicted in the extreme right of Figure 12-4. We recommend checking out the paper *Very Deep Convolutional Networks for Large-Scale Image Recognition* by [Karen Simonyan](#) and [Andrew Zisserman](#) of the Visual Geometry Group, Department of Engineering Science, University of Oxford. The paper is available at <https://arxiv.org/abs/1409.1556> and talks in detail about the architecture of these models.

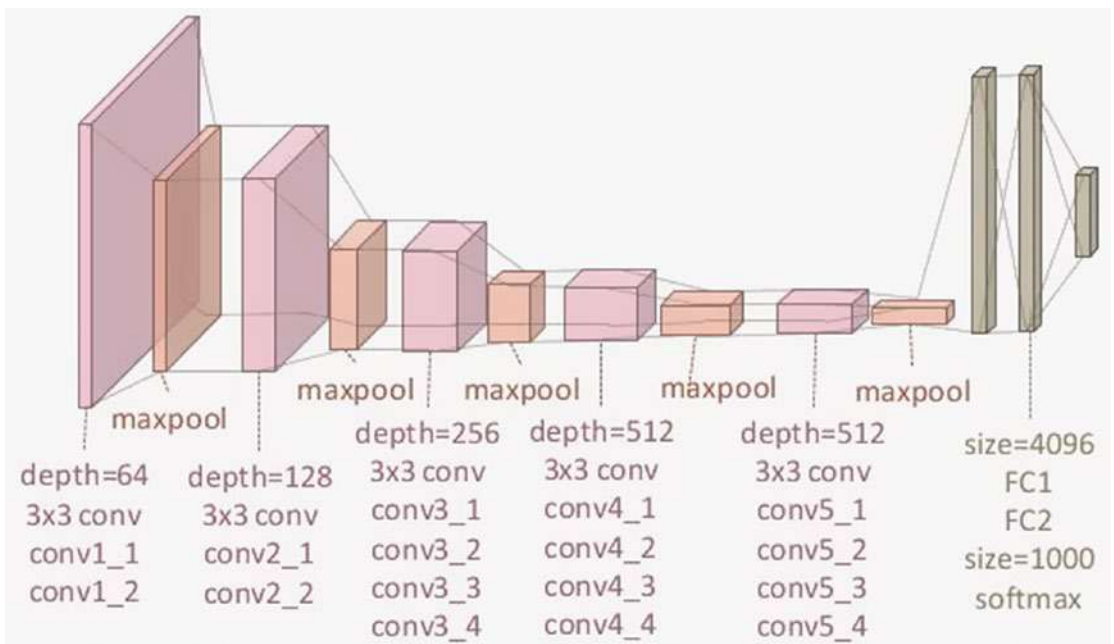

**Figure 12-4.** Visual depiction of the VGG-19 architecture

Loading the CIFAR10 training and test datasets is the same as discussed in the previous section. We perform similar one hot encoding of the labels as well. Since the VGG19 model has been loaded without the final fully connected layers, the `predict(...)` function of the model helps us get the extracted features on our dataset. The following snippet extracts the features for both training and test datasets.

```
In [2]: bottleneck_features_train = vgg_model.predict(x_train, verbose=1)
...: bottleneck_features_test = vgg_model.predict(x_test, verbose=1)
```

These features are widely known as *bottleneck* features due to the fact that there is an overall decrease in the volume of the input data points. It would be worth exploring the model summary to understand how the VGG model transforms the data. The output of this stage (the bottleneck features) is used as input to the classifier we are going to build next. The following snippet builds a simple fully connected two-layer classifier.

```
In [3]: clf_model = Sequential()
...: clf_model.add(Flatten(input_shape=bottleneck_features_train.shape[1:]))
...: clf_model.add(Dense(512, activation='relu'))
...: clf_model.add(Dropout(0.5))
...: clf_model.add(Dense(256, activation='relu'))
...: clf_model.add(Dropout(0.5))
...: clf_model.add(Dense(num_classes, activation='softmax'))
...: clf_model.compile(loss=keras.losses.categorical_crossentropy,
                       optimizer=keras.optimizers.Adadelta(),
                       metrics=['accuracy'])
```

The model's input layer matches the dimensions of the *bottleneck* features (for obvious reasons). As with the CNN model we built from scratch, this model also has a dense output layer with softmax activation function. Training this model as opposed to a complete VGG19 is fairly simple and fast, as depicted in the following snippet.

```
In [4]: clf_model.fit(bottleneck_features_train, y_train, batch_size=batch_size,
...:                 epochs=epochs, verbose=1)
Epoch 1/50
50000/50000 [=====] - 8s - loss: 7.2495 - acc: 0.2799
Epoch 2/50
50000/50000 [=====] - 7s - loss: 2.2513 - acc: 0.2768
Epoch 3/50
50000/50000 [=====] - 7s - loss: 1.9096 - acc: 0.3521
...
Epoch 48/50
50000/50000 [=====] - 8s - loss: 0.9368 - acc: 0.6814
Epoch 49/50
50000/50000 [=====] - 8s - loss: 0.9223 - acc: 0.6832
Epoch 50/50
50000/50000 [=====] - 8s - loss: 0.9197 - acc: 0.6830
```

We can add hooks to stop the training early based of early stop criteria, etc. But for now, we keep things simple. Complete code for this section is available in the notebook `notebook_pretrained_cnn_cifar10_classifier.ipynb`. Overall, we achieve an accuracy of 68% on the training dataset and around 64% on the test dataset.

Now you'll see the performance of this classifier built on top a pre-trained model on the test dataset. The following snippet showcases a utility function that takes the index number of an image in the test dataset as input and compares the actual labels and the predicted labels.

```
def predict_label(img_idx, show_proba=True):
    plt.imshow(x_test[img_idx], aspect='auto')
    plt.title("Image to be Labeled")
    plt.show()
```

```

print("Actual Class:{}".format(np.nonzero(y_test[img_idx])[0][0]))

test_image = np.expand_dims(x_test[img_idx], axis=0)
bf = vgg_model.predict(test_image, verbose=0)
pred_label = clf_model.predict_classes(bf, batch_size=1, verbose=0)

print("Predicted Class:{}".format(pred_label[0]))
if show_proba:
    print("Predicted Probabilities")
    print(clf_model.predict_proba(bf))

```

The following is the output of the `predict_label(...)` function when tested against a couple of images from the test dataset. As depicted in Figure 12-5, we correctly predicted the images belong to class label 5 (dog) and 9 (truck)!

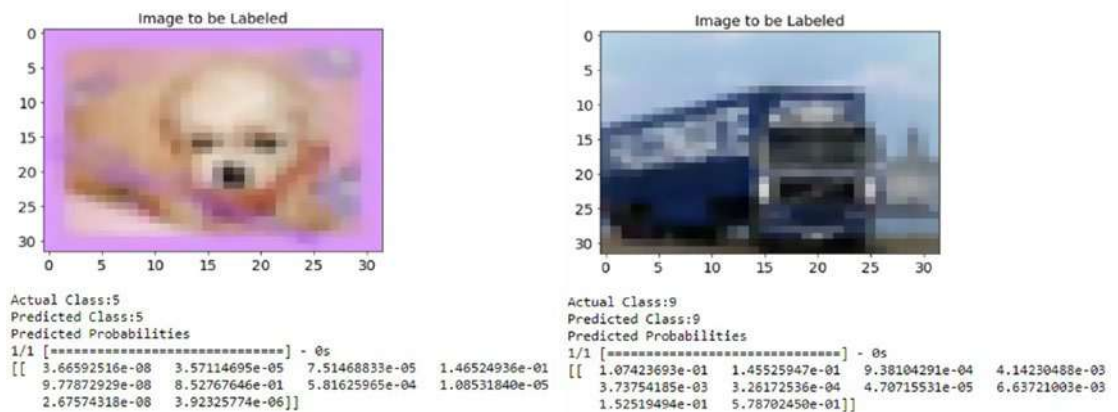

**Figure 12-5.** Predicted labels from pre-trained CNN based classifier

This section demonstrated the power and advantages of *transfer learning*. Instead of spending time reinventing the wheel, with a few lines of code, we were able to leverage state of the art neural network for our classification task.

The concept of transfer learning is what forms the basis of neural *style transfer*, which we will discuss in the next section.

## Artistic Style Transfer with CNNs

Paintings (or for that matter any form of art) require special skill which a few have mastered. Paintings present complex interplay of content and style. Photographs on the other hand are a combination of perspectives and light. When the two are combined, the results are spectacular and surprising. One such example is shown in Figure 12-6.



**Figure 12-6.** Left Image: The original photograph depicting the Neckarfront in Tübingen, Germany. Right Image: The painting (inset: *The Starry Night* by Vincent van Gogh) that provided the style for the respective generated image. Source: *A Neural Algorithm of Artistic Style*, Gatys et al. (arXiv:1508.06576v2)

The results in Figure 12-6 showcase how a painting's (Van Gogh's *The Starry Night*) style has been transferred to a photograph of the Neckarfront. At first glance, the process seems to have picked up the content from the photograph, the style, colors, and stroke patterns from the painting and generated the final outcome. The results are amazing, but what is more surprising is, how was it done?

Figure 12-6 showcases a process termed as *artistic style transfer*. The process is an outcome of research by Gatys et al. and is presented in their paper *A Neural Algorithm for Artistic Style*. In this section, we discuss the intricacies of this paper from an implementation point of view and see how we can perform this technique ourselves.

---

■ **Note** Prisma is an app that transforms photos into works of art using techniques of *artistic style transfer* based on convolution neural networks. More about the app is available at <https://prisma-ai.com/>.

---

## Background

Formally, neural style transfer is the process of applying the “style” of a reference image to a specific target image such that in the process, the original “content” of the target image remains unchanged. Here, style is defined as colors, patterns, and textures present in the reference image, while content is defined as the overall structure and higher-level components of the image.

The main objective here is then, to retain the content of the original target image, while superimposing or adopting the style of the reference image on the target image. To define this concept mathematically, consider three images—the *original content* (denoted as  $c$ ), the *reference style* (denoted as  $s$ ), and the *generated image* (denoted as  $g$ ). Thus, we need a way to measure how different are images  $c$  and  $g$  in terms of their content. A function that tends to 0 if  $c$  and  $g$  are completely different and grows otherwise. This can be concisely stated in terms of a loss function as:

$$L_{content} = distance(c, g)$$

Where *distance* is a norm function like  $L2$ . On the same lines, we can define another function that captures how different images  $s$  and  $g$  are in terms of their style. In other words, this can be stated as follows:

$$L_{style} = distance(s, g)$$

Thus, for the overall process of neural style transfer, we have an overall loss function, which can be defined as a combination of content and style loss functions.

$$L_{\text{style-transfer}} = \operatorname{argmin}_g (\alpha L_{\text{content}}(c, g) + \beta L_{\text{style}}(s, g))$$

Where  $\alpha$  and  $\beta$  are weights used to control the impact of content and style components on the overall loss. The loss function we will try to minimize consists of three parts namely, the *content loss*, the *style loss*, and the *total variation loss*, which we will be talking about later.

The beauty of Deep Learning is that by leveraging architectures like deep convolutional neural networks (CNNs), we can mathematically define the above-mentioned style and content functions. We will be using principles of transfer learning in building our system for neural style transfer. We introduced the concept of transfer learning using a pre-trained deep CNN model like VGG-19. We will be leveraging the same pre-trained model for the task of neural style transfer. The main steps are outlined as follows.

- Leverage VGG-19 to help compute layer activations for the style, content, and generated image.
- Use these activations to define specific loss functions mentioned earlier.
- Finally, use gradient descent to minimize the overall loss.

We recommend you follow along this section with the notebook titled `Neural Style Transfer.ipynb`, which contains step-by-step details of the style transfer process. We would also like to give a special mention and thanks to François Chollet as well as Harish Narayanan for providing some excellent resources on style transfer. Details on the same will be mentioned later. We also recommend you check out the following papers (detailed links shared later on).

- *A Neural Algorithm of Artistic Style* by [Leon A. Gatys](#), [Alexander S. Ecker](#), and [Matthias Bethge](#)
- *Perceptual Losses for Real-Time Style Transfer and Super-Resolution* by [Justin Johnson](#), [Alexandre Alahi](#), and [Li Fei-Fei](#)

## Preprocessing

The first and foremost step toward implementation of such a network is to preprocess the data or images in this case. The following are quick utilities to preprocess images for size and channel adjustments.

```
import numpy as np
from keras.applications import vgg19
from keras.preprocessing.image import load_img, img_to_array

def preprocess_image(image_path, height=None, width=None):
    height = 400 if not height else height
    width = width if width else int(width * height / height)
    img = load_img(image_path, target_size=(height, width))
    img = img_to_array(img)
    img = np.expand_dims(img, axis=0)
    img = vgg19.preprocess_input(img)
    return img

def deprocess_image(x):
    # Remove zero-center by mean pixel
    x[:, :, 0] += 103.939
```

```

x[:, :, 1] += 116.779
x[:, :, 2] += 123.68
# 'BGR' -> 'RGB'
x = x[:, :, ::-1]
x = np.clip(x, 0, 255).astype('uint8')
return x

```

As we would be writing custom loss functions and manipulation routines, we would need to define certain placeholders. `keras` is a high-level library that utilizes tensor manipulation backends (like `tensorflow`, `theano`, and `CNTK`) to perform the heavy lifting. Thus, these placeholders provide high-level abstractions to work with the underlying *tensor* object. The following snippet prepares placeholders for style, content, and generated images along with the input tensor for the neural network.

```

In [1]: # This is the path to the image you want to transform.
...: TARGET_IMG = 'data/city_road.jpg'
...: # This is the path to the style image.
...: REFERENCE_STYLE_IMG = 'data/style2.png'
...:
...: width, height = load_img(TARGET_IMG).size
...: img_height = 320
...: img_width = int(width * img_height / height)
...:
...:
...: target_image = K.constant(preprocess_image(TARGET_IMG,
...:                                           height=img_height,
...:                                           width=img_width))
...: style_image = K.constant(preprocess_image(REFERENCE_STYLE_IMG,
...:                                           height=img_height,
...:                                           width=img_width))
...:
...: # Placeholder for our generated image
...: generated_image = K.placeholder((1, img_height, img_width, 3))
...:
...: # Combine the 3 images into a single batch
...: input_tensor = K.concatenate([target_image,
...:                               style_image,
...:                               generated_image], axis=0)

```

We will load the pre-trained VGG-19 model as we did in the previous section, i.e., without the top fully connected layers. The only difference here is that we would be providing the model constructor, the size dimensions of the input tensor. The following snippet fetches the pretrained model.

```

In [2]: model = vgg19.VGG19(input_tensor=input_tensor,
...:                        weights='imagenet',
...:                        include_top=False)

```

You may use the `summary()` function to understand the architecture of the pre-trained model.

## Loss Functions

As discussed in the background subsection, the problem of neural style transfer revolves around loss functions of content and style. In this subsection, we will discuss and define the required loss functions.

### Content Loss

In any CNN-based model, activations from top layers contain more global and abstract information (high-level structures like a face) and bottom layers will contain local information (low-level structures like eyes, nose, edges, and corners) about the image. We would want to leverage the top layers of a CNN for capturing the right representations for the content of an image.

Hence, for the content loss, considering we will be using the pretrained VGG-19 CNN, we can define our loss function as the L2 norm (scaled and squared Euclidean distance) between the activations of a top layer (giving feature representations) computed over the target image and the activations of the same layer computed over the generated image. Assuming we usually get feature representations relevant to the content of images from the top layers of a CNN, the generated image is expected to look similar to the base target image. The following snippet showcases the function to compute the content loss.

```
def content_loss(base, combination):
    return K.sum(K.square(combination - base))
```

### Style Loss

The original paper on neural style transfer, A Neural Algorithm of Artistic Style by Gatys et al., leverages multiple convolutional layers in the CNN (instead of one) to extract meaningful patterns and representations capturing information pertaining to appearance or style from the reference style image across all spatial scales irrespective of the image content.

Staying true to the original paper, we will be leveraging the *Gram matrix* and computing the same over the feature representations generated by the convolution layers. The Gram matrix computes the inner product between the feature maps produced in any given conv layer. The inner products terms are proportional to the covariances of corresponding feature sets and hence captures patterns of correlations between the features of a layer that tend to activate together. These feature correlations help capture relevant aggregate statistics of the patterns of a particular spatial scale, which correspond to the style, texture, and appearance and not the components and objects present in an image.

The style loss is thus defined as the scaled and squared *Frobenius* norm of the difference between the Gram matrices of the reference style and the generated images. Minimizing this loss helps ensure that the textures found at different spatial scales in the reference style image will be similar in generated image.

The following snippet thus defines a style loss function based on Gram matrix calculation.

```
def style_loss(style, combination, height, width):

    def build_gram_matrix(x):
        features = K.batch_flatten(K.permute_dimensions(x, (2, 0, 1)))
        gram_matrix = K.dot(features, K.transpose(features))
        return gram_matrix

    S = build_gram_matrix(style)
    C = build_gram_matrix(combination)
    channels = 3
    size = height * width
    return K.sum(K.square(S - C)) / (4. * (channels ** 2) * (size ** 2))
```



## Total Variation Loss

It was observed that optimization to reduce only the style and content losses led to highly pixelated and noisy outputs. To cover the same, *total variation loss* was introduced.

The total variation loss is analogous to *regularization loss*. This is introduced for ensuring spatial continuity and smoothness in the generated image to avoid noisy and overly pixelated results. The same is defined in the function as follows.

```
def total_variation_loss(x):
    a = K.square(
        x[:, :img_height - 1, :img_width - 1, :] - x[:, 1:, :img_width - 1, :])
    b = K.square(
        x[:, :img_height - 1, :img_width - 1, :] - x[:, :img_height - 1, 1:, :])
    return K.sum(K.pow(a + b, 1.25))
```

## Overall Loss Function

Having defined the components of the overall loss function for neural style transfer, the next step is to piece together these building blocks. Since content and style information is captured by the CNNs at different depths in the network, we need to apply and calculate loss at appropriate layers for each type of loss.

Utilizing insights and research by Gatys et al. and Johnson et al. in their respective papers, we define the following utility to identify the content and style layers from the VGG-19 model. Even though Johnson et al. leverages the VGG-16 model for faster and better performance, we constrain ourselves to the VGG-19 model for ease of understanding and consistency across runs.

```
# define function to set layers based on source paper followed
def set_cnn_layers(source='gatys'):
    if source == 'gatys':
        # config from Gatys et al.
        content_layer = 'block5_conv2'
        style_layers = ['block1_conv1', 'block2_conv1', 'block3_conv1',
                       'block4_conv1', 'block5_conv1']
    elif source == 'johnson':
        # config from Johnson et al.
        content_layer = 'block2_conv2'
        style_layers = ['block1_conv2', 'block2_conv2', 'block3_conv3',
                       'block4_conv3', 'block5_conv3']
    else:
        # use Gatys config as the default anyway
        content_layer = 'block5_conv2'
        style_layers = ['block1_conv1', 'block2_conv1', 'block3_conv1',
                       'block4_conv1', 'block5_conv1']
    return content_layer, style_layers
```

The following snippet then applies the overall loss function based on the layers selected from the `set_cnn_layers()` function for content and style.

```
In [2]: # weights for the weighted average loss function
...: content_weight = 0.025
...: style_weight = 1.0
...: total_variation_weight = 1e-4
```

```

...:
...: # set the source research paper followed and set the content and style layers
...: source_paper = 'gatys'
...: content_layer, style_layers = set_cnn_layers(source=source_paper)
...:
...: ## build the weighted loss function
...:
...: # initialize total loss
...: loss = K.variable(0.)
...:
...: # add content loss
...: layer_features = layers[content_layer]
...: target_image_features = layer_features[0, :, :, :]
...: combination_features = layer_features[2, :, :, :]
...: loss += content_weight * content_loss(target_image_features,
...:                                     combination_features)
...:
...: # add style loss
...: for layer_name in style_layers:
...:     layer_features = layers[layer_name]
...:     style_reference_features = layer_features[1, :, :, :]
...:     combination_features = layer_features[2, :, :, :]
...:     sl = style_loss(style_reference_features, combination_features,
...:                    height=img_height, width=img_width)
...:     loss += (style_weight / len(style_layers)) * sl
...:
...: # add total variation loss
...: loss += total_variation_weight * total_variation_loss(generated_image)

```

## Custom Optimizer

The objective is to iteratively minimize the overall loss with the help of an optimization algorithm. In the paper by Gatys et al., optimization was done using the L-BFGS algorithm, which is an optimization algorithm based on *quasi-Newton* methods, which is popularly used for solving non-linear optimization problems and parameter estimation. This method usually converges faster than *standard gradient descent*. SciPy has an implementation available in `scipy.optimize.fmin_l_bfgs_b()`. However, limitations include the function being applicable only to flat 1D vectors, unlike 3D image matrices which we are dealing with, and the fact that value of loss function and gradients need to be passed as two separate functions.

We build an Evaluator class based on patterns followed by keras creator François Chollet to compute both loss and gradients values in one pass instead of independent and separate computations. This will return the loss value when called the first time and will cache the gradients for the next call. Thus, it would be more efficient than computing both independently. The following snippet defines the Evaluator class.

```

class Evaluator(object):

    def __init__(self, height=None, width=None):
        self.loss_value = None
        self.grads_values = None
        self.height = height
        self.width = width

```

```

def loss(self, x):
    assert self.loss_value is None
    x = x.reshape((1, self.height, self.width, 3))
    outs = fetch_loss_and_grads([x])
    loss_value = outs[0]
    grad_values = outs[1].flatten().astype('float64')
    self.loss_value = loss_value
    self.grad_values = grad_values
    return self.loss_value

def grads(self, x):
    assert self.loss_value is not None
    grad_values = np.copy(self.grad_values)
    self.loss_value = None
    self.grad_values = None
    return grad_values

```

The loss and gradients are retrieved as follows. The snippet also creates an object of the Evaluator class.

```

In [3]: # Get the gradients of the generated image wrt the loss
...: grads = K.gradients(loss, generated_image)[0]
...:
...: # Function to fetch the values of the current loss and the current gradients
...: fetch_loss_and_grads = K.function([generated_image], [loss, grads])
...:
...: # evaluator object
...: evaluator = Evaluator(height=img_height, width=img_width)

```

## Style Transfer in Action

The final piece of the puzzle is to use all the building blocks and see the style transfer in action. The art/style and content images are available *data* directory for reference. The following snippet outlines how loss and gradients are evaluated. We also write back outputs after regular intervals (5, 10, and so on iterations) to later understand how the process of neural style transfer transforms the images in consideration.

```

In [4]: result_prefix = 'style_transfer_result_'+TARGET_IMG.split('.')[0]
...: result_prefix = result_prefix+'_'+source_paper
...: iterations = 20
...:
...: # Run scipy-based optimization (L-BFGS) over the pixels of the generated image
...: # so as to minimize the neural style loss.
...: # This is our initial state: the target image.
...: # Note that `scipy.optimize.fmin_l_bfgs_b` can only process flat vectors.
...: x = preprocess_image(TARGET_IMG, height=img_height, width=img_width)
...: x = x.flatten()
...:
...: for i in range(iterations):
...:     print('Start of iteration', (i+1))
...:     start_time = time.time()
...:     x, min_val, info = fmin_l_bfgs_b(evaluator.loss, x,
...:                                     fprime=evaluator.grads, maxfun=20)

```

```

...:     print('Current loss value:', min_val)
...:     if (i+1) % 5 == 0 or i == 0:
...:         # Save current generated image only every 5 iterations
...:         img = x.copy().reshape((img_height, img_width, 3))
...:         img = deprocess_image(img)
...:         fname = result_prefix + '_at_iteration_%d.png' %(i+1)
...:         imsave(fname, img)
...:         print('Image saved as', fname)
...:     end_time = time.time()
...:     print('Iteration %d completed in %ds' % (i+1, end_time - start_time))

```

It must be pretty evident by now that neural style transfer is a computationally expensive task. For the set of images in consideration, each iteration took between 500-1000 seconds on a Intel i5 CPU with 8GB RAM. On an average, each iteration takes around 500 seconds but if you run multiple networks together, each iteration takes up to 1,000 seconds. You may observe speedups if the same is done using GPUs. The following is the output of some of the iterations. We print the loss and time taken for each iteration and save the image after five iterations.

```

Start of iteration 1
Current loss value: 2.4219e+09
Image saved as style_transfer_result_city_road_gatys_at_iteration_1.png
Iteration 1 completed in 506s
Start of iteration 2
Current loss value: 9.58614e+08
Iteration 2 completed in 542s
Start of iteration 3
Current loss value: 6.3843e+08
Iteration 3 completed in 854s
Start of iteration 4
Current loss value: 4.91831e+08
Iteration 4 completed in 727s
Start of iteration 5
Current loss value: 4.03013e+08
Image saved as style_transfer_result_city_road_gatys_at_iteration_5.png
Iteration 5 completed in 878s
...
Start of iteration 19
Current loss value: 1.62501e+08
Iteration 19 completed in 836s
Start of iteration 20
Current loss value: 1.5698e+08
Image saved as style_transfer_result_city_road_gatys_at_iteration_20.png
Iteration 20 completed in 838s

```

Now you'll learn how the neural style transfer has worked out for the images in consideration. Remember that we performed checkpoint outputs after certain iterations for every pair of style and content images.

■ **Note** The style we use for our first image, depicted in Figure 12-7, is named **Edtaonisl**. This is a 1913 master piece by Francis Picabia. Through this oil painting Francis Picabia pioneered a new visual language. More details about this painting are available at <http://www.artic.edu/aic/collections/artwork/80062>.

We utilize `matplotlib` and `skimage` libraries to load and understand the style transfer magic! The following snippet loads the city road image as our content and *Edtaonisl* painting as our style image.

```
In [5]: from skimage import io
...: from glob import glob
...: from matplotlib import pyplot as plt
...:
...: cr_content_image = io.imread('results/city road/city_road.jpg')
...: cr_style_image = io.imread('results/city road/style2.png')
...:
...:
...: fig = plt.figure(figsize = (12, 4))
...: ax1 = fig.add_subplot(1,2, 1)
...: ax1.imshow(cr_content_image)
...: t1 = ax1.set_title('City Road Image')
...: ax2 = fig.add_subplot(1,2, 2)
...: ax2.imshow(cr_style_image)
...: t2 = ax2.set_title('Edtaonisl Style')
```

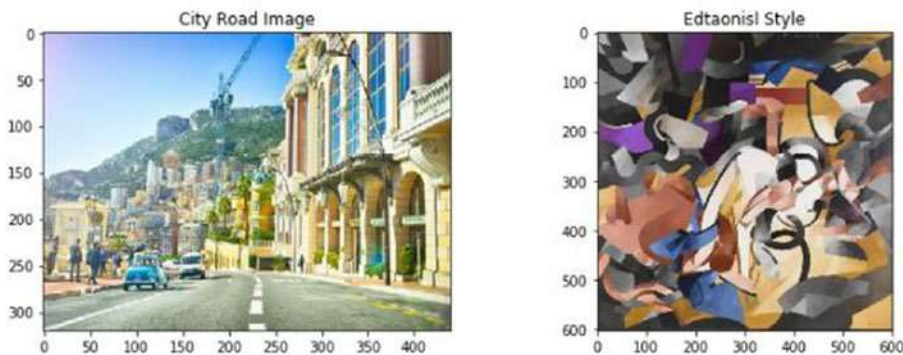

**Figure 12-7.** The City Road image as content and the *Edtaonisl* painting as style image for neural style transfer

The following snippet loads the generated images (style transferred images) as observed after the first, tenth, and twentieth iteration.

```
In [6]: fig = plt.figure(figsize = (20, 5))
...: ax1 = fig.add_subplot(1,3, 1)
...: ax1.imshow(cr_iter1)
...: t1 = ax1.set_title('Iteration 1')
...: ax2 = fig.add_subplot(1,3, 2)
...: ax2.imshow(cr_iter10)
```

```

...: t2 = ax2.set_title('Iteration 10')
...: ax3 = fig.add_subplot(1,3, 3)
...: ax3.imshow(cr_iter20)
...: t3 = ax3.set_title('Iteration 20')
...: t = fig.suptitle('City Road Image after Style Transfer')

```



**Figure 12-8.** The City Road image style transfer at the first, tenth, and twentieth iteration

The results depicted in Figure 12-8 sure seem pleasant and amazing. It is quite apparent how the generated image in the initial iterations resembles the structure of the content and, as the iterations progress, the style starts influencing the texture, color, strokes, and so on, more and more.

---

■ **Note** The style used in our next example depicted in Figure 12-9 is the famous painting named *The Great Wave* by Katsushika Hokusai. The artwork was completed in 1830-32. It is amazing to see the styles of such talented artists being transferred to everyday photographs. More on this artwork is available at <http://www.metmuseum.org/art/collection/search/36491>.

---

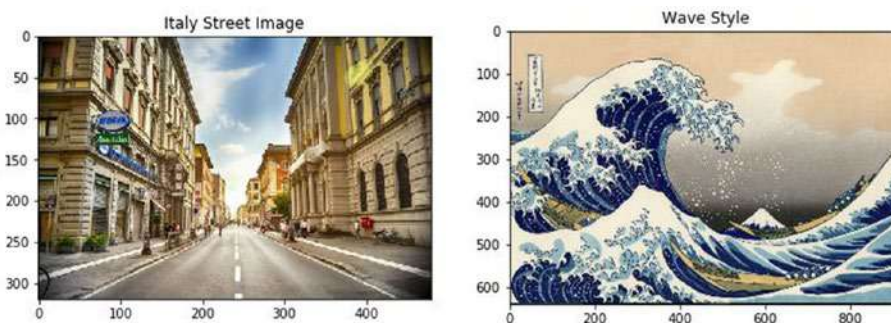

**Figure 12-9.** The Italy Street image as content and Wave Style painting as the style image for neural style transfer

We experimented with a few more sets of images and the results truly were surprising and pleasant to look at. The output from neural style transfer for an image depicting an Italian street (see Figure 12-9) is shown in Figure 12-10 at different iterations.



**Figure 12-10.** Italian street image style transfer at the first, tenth and twentieth iteration

The results depicted in Figure 12-10 are definitely a pleasure to look at and give the feeling of an entire city underwater! We encourage you to use images of your own with this same framework. Also feel free to experiment with leveraging different convolution layers for the style and content feature representations as mentioned in Gatys et al. and Johnson et al.

---

■ **Note** The concept and details of neural style transfer were introduced and explained by Gatys et al. and Johnson et al. in their respective papers available at <https://arxiv.org/abs/1508.06576> and <https://arxiv.org/abs/1603.08155>. You can also check out the book *Deep Learning with Python* by François Chollet as well as Harish Narayanan's excellent blog for a detailed step-by-step guide on neural style transfer: <https://harishnarayanan.org/writing/artistic-style-transfer/>.

---

## Summary

This chapter presented topics from the very forefront of the Machine Learning landscape. Through this chapter we utilized our learnings about Machine Learning in general and Deep Learning in particular to understand the concepts of image classification, transfer learning, and style transfer. The chapter started off with a quick brush up of concepts related to Convolutional Neural Networks and how they are optimized architectures to handle image related data. We then worked towards developing image classifiers. The first classifier was developed from scratch and with the help of `keras` we were able to achieve decent results. The second classifier utilized a pre-trained VGG-19 deep CNN model as an image feature extractor. The pre-trained model based classifier helped us understand the concept of transfer learning and how it is beneficial. The closing section of the chapter introduced the advanced topic of Neural Style Transfer, the main highlight of this chapter. Style transfer is the process of applying the style of a reference image to a specific target image such that in the process, the original content of the target image remains unchanged. This process utilizes the potential of CNNs to understand image features at different granularities along with transfer learning. Based on our understanding of these concepts and the research work by Gatys et al. and Johnson et al., we provided a step-by-step guide to implement a system of neural style transfer. We concluded the section by presenting some amazing results from the process of neural style transfer.

Deep Learning is opening new doors every day. Its application to different domains and problems is showcasing its potential to solve problems previously unknown. Machine Learning is an ever evolving and a very involved field. Through this book, we traveled from the basics of Machine Learning frameworks, Python ecosystem to different algorithms and concepts. We then covered multiple use cases across chapters showcasing different scenarios and ways a problem can be solved using the tools from the Machine Learning toolbox. The universe of Machine Learning is expanding at breakneck speeds; our attempt here was to get you started on the right track, on this wonderful journey.

# Index

## ■ A

Advanced supervised deep learning models  
dense layer, 361  
embedding layer, 355, 357  
LSTM-based classification model, 355  
LSTM cell  
architecture, 360  
data flow, 361  
model performance metrics, LSTM, 362  
most\_common(count) function, 356  
norm\_train\_reviews and  
norm\_test\_reviews, 355  
PAD\_INDEX, 355  
parameters, Embedding  
layer, 358  
RNN and LSTM units, structure, 359  
text sentiment class labels, 356  
tokenized\_train corpus, 355  
word embeddings generation, 358

AFINN lexicon, 338–339  
Algorithmic trading, 483  
Annotations, 175  
Anomaly detection, 41  
Applied computer science, *See* Practical computer  
science  
Area under curve (AUC), 277, 432  
Array elements  
advanced indexing, 79  
basic indexing  
and slicing, 77–78  
boolean indexing, 80  
integer array indexing, 79  
linear algebra, 82–83  
operations, 80–82  
Artificial intelligence (AI)  
defined, 14, 25  
major facets, 25, 26  
NLP, 14  
objectives, 26  
text analytics, 14  
Artificial neural networks (ANNs), 31, 102–104, 352

Artistic style transfer, CNNs  
in action, 516–519  
background, 510–511  
custom optimizer, 515–516  
loss functions  
content loss, 513  
overall loss function, 514–515  
style loss, 513  
total variation loss, 514  
preprocessing, 511–512  
Association rule-mining method, 41  
Autoencoders, 34  
Auto feature generation, 184  
Auto Regressive Integrated Moving Average  
(ARIMA) model, 475–476  
Axis controls  
adjust axis, 173  
log scale, 174  
tick range, 173–174  
y-axis, 172

## ■ B

Backpropagation algorithm, 32  
Backward elimination, 248  
Bagging methods, 437  
Bag of N-grams model, 212  
Bag of words model  
numeric vector, 211  
visual, 233–236  
Bar plots, 154–155  
Batch learning methods, 43  
Bayes Theorem, 24  
Bias and variance  
generalization error, 287  
overfitting, 287  
tradeoff, 284–285, 287  
underfitting, 287  
Bike Sharing dataset  
EDA  
correlations, 314–315  
distribution and trends, 310, 312



- Bike Sharing dataset (*cont.*)
  - outliers, 312–313
  - preprocessing, 308–310
- linear regression, 320–321
- modeling (*see* Modeling, Bike Sharing dataset)
- problem statement, 308
- regression analysis
  - assumptions, 316
  - cross validation, 317
  - normality test, 316–317
  - residual analysis, 316
  - R-squared, 317
  - types, 315
- Binary classification model, 258
- Bin-counting scheme, 208
- Bing Liu’s lexicon, 337
- Binning image intensity distribution, 227
- Boosting methods, 437
- Bot, *See* Web crawler
- Box-Cox transform, 198–200
- Box plots, 157–158
- Building machine intelligence, 52

**C**

- Calinski-Harabaz index, 280–281
- Candidate model, 256
- Canny edge detector, 229
- Categorical data
  - encoding features
    - bin-counting scheme, 208
    - dummy coding scheme, 206
    - effect coding scheme, 207
    - one hot encoding scheme, 203, 205
  - feature hashing scheme, 208
  - nominal, 200–202
  - ordinal, 200, 202–203
- Categorical variables, 137
- Channel pixels, 225–227
- Chi-square test, 245–246
- Classification models
  - binary classification, 258
  - confusion matrix
    - accuracy, 274
    - F1 score, 275
    - precision, 274–275
    - structure, 272–273
    - test dataset, 272
  - handwritten digit, 264–266
  - multi-class classification, 258
  - output formats, 258
- Clustering methods, 39
- Clustering models
  - Calinski-Harabaz index, 280–281
  - completeness, 279
  - density based, 260
  - distance between data points, 279
  - evaluation, 278
  - hierarchical, 260, 269–270
  - homogeneity, 279
  - partition based, 260, 267–268
  - SC, 280
  - V-measure, 279
- Clustering strategy
  - data cleaning
    - cluster analysis, 387, 389–392
    - CustomerID field, 381
    - data preprocessing, 383–385
    - frequency and monetary value, 382–383
    - K-means clustering, 386–387
    - recency, 381–382
    - separate transactions, geographical region, 380
    - RFM model, customer value, 380
  - Clustering *vs.* customer segmentation, 379
- Comma Separated Values (CSV)
  - dataframe, 85–87
  - dict, 123
  - pandas, 123
  - reader function, 123
  - sample file, 122
- Computation, theory of, 15
- Computer science (CS)
  - algorithms, 15
  - code, 16
  - data structures, 16
  - defined, 14
  - practical, 15
  - programming languages, 16
  - theoretical, 15
- Conditional probability, 23
- Confusion matrix
  - accuracy, 274
  - F1 score, 275
  - precision, 274–275
  - structure, 272–273
  - test dataset, 272
- Content-based recommendation engines, 457
- Convolutional neural networks (CNNs)
  - architecture, 500
  - artistic style transfer (*see* Artistic style transfer, CNNs)
  - components, 32–33
  - feature map visualizations, 238–239
  - image classification
    - dataset, 501
    - deep learning classifier, pretrained models, 505–509
    - deep learning classifier, scratch, 502–505
    - problem statement, 501

- two-layer
  - pooling, 236
  - stride, 236
  - visualizing, 237
- Cross Industry Standard Process for Data Mining (CRISP-DM) process model
  - assessment stage, 47
  - attribute generation, 50
  - building machine intelligence, 52
  - business context and requirements, 46
  - business problem, 47
  - data collection, 48
  - data description, 49
  - data integration, 50
  - data mining lifecycle, 45–46
  - data mining problem, 48
  - data preparation, 50
  - data quality analysis, 49
  - data understanding, 48
  - data wrangling, 50
  - deployment, 52
  - EDA, 49
  - evaluation phase, 52
  - ML pipelines
    - data preparation, 53
    - data processing and wrangling, 53
    - data retrieval, 53
    - deployment and monitoring, 54
    - feature extraction and engineering, 53
    - feature scaling and selection, 54
    - model evaluation and tuning, 54
    - modeling, 54
    - standard, 53
    - supervised, 54
    - unsupervised, 55
  - model assessment, 51
  - project plan, 48
  - training model, 51
  - tuned models, 51
- Cross selling, association rule-mining
  - dependencies, 396
  - EDA, 396–397, 399–400
  - FP growth, 395–396, 401–405
  - market basket analysis, 393–394
  - orange table data structure, 400
  - transaction set, 394
- Cross validation (CV)
  - K-fold, 291
  - model building and tuning, 288–290
  - single data point, 291
- Curse of dimensionality, 40
- Customer segmentation
  - clustering strategy (*see* Clustering strategy)
  - objectives
    - customer understanding, 378
    - higher revenue, 379

- latent customer segments, 379
- optimal product placement, 378
- target marketing, 378
- strategies
  - clustering, 379
  - EDA, 379
- Custom optimizer, 515

## D

- 2Darray, *See* Matrix
- Data collection
  - CSV file, 122–123
  - defined, 121–122
  - HTML, 131–132
  - JSON, 124, 126–127
  - SQL, 136
  - Web scraping (*see* Web scraping)
- Data description
  - categorical, 137
  - defined, 121
  - numeric, 137
  - text, 137
- Data-driven decisions, 4, 7
- Data mining, 14, 25
  - problem, 48
- Data munging, *See* Data wrangling
- Data Science, 16–18
- Datasets, 25, 178
- Data structures, 16
- Data summarization
  - agg() function, 151
  - groupby() function, 150
  - quantity\_purchased, 151
  - user\_class, 150
- Data visualization
  - defined, 121
  - matplotlib
    - annotations, 175
    - axis controls, 172–174
    - figure and subplots, 162–167
    - global parameters, 176
    - graph legend, 170–171
    - plot formatting, 167–170
    - pylab, 161
    - pyplot, 161
  - pandas, 152
    - bar plots, 154–155
    - box plots, 157–158
    - histograms, 155–156
    - line charts, 152–154
    - pie charts, 156–157
    - scatter plots, 158–161
- Data wrangling
  - defined, 121
  - downstream steps, 138

Data wrangling (*cont.*)

- product purchase transactions dataset
  - attributes/features/properties, 139–140
  - categorical data, 147–148
  - duplicates, 147
  - filtering data, 141, 143
  - missing values, 145–146
  - normalization process, 148
  - string data, 149
  - transformations, 144–145
  - typecasting, 144
- Date-based features, 221
- Decision tree, 283, 295
- Decision tree based regression
  - algorithms, 325
  - hyperparameters, 325–327, 329
  - node splitting, 324–325
  - stopping criteria, 325
  - testing, 329
  - training, 326–329
- Decision Tree Regressor, 326, 328–329
- Deep Learning, 14
  - ANN, 31
  - architectures, 30
  - autoencoder, 34
  - backpropagation, 32
  - characteristics, 29
  - CNN, 32–33
  - comparing learning pipelines, 30
  - comparison of machine learning and, 29
  - distributed representational, 29
  - hierarchical layered representation, 29
  - keras, 108
  - LSTMs, 34
  - MLP, 32
  - model building process, 109
  - neural network, 30, 109–111
  - power, 111–112
  - representational learning, 28
  - RNN, 33
  - tensorflow packages, 107
  - theano packages, 105–106
- Deep neural network (DNN), 352
- Density based clustering models, 260
- Deployment model
  - custom development, 303
  - persistence model, 302
  - service, 304
- Descriptive statistics, 24
- Distributed Machine Learning Community (DMLC), 440
- Document Object Model (DOM) parser, 129
- Dummy coding scheme, 206

■ E

- EDA, *See* Exploratory data analysis (EDA)
- Effect coding scheme, 207
- Efficient market hypothesis, 483
- Eigen decomposition, 21–22
- Embedded methods, 242
- Ensemble model, 248
- Euler’s number, 197
- Exploratory data analysis (EDA), 49, 155, 374–376
  - correlations, 314–315
  - data enhancing, 451–452
  - distribution and trends, 310, 312
  - loading and trimming data, 448, 450–451
  - outliers, 312–313
  - preprocessing, 308–310
  - visual analysis
    - popular artist, 454
    - popular songs, 452–453
    - user *vs.* songs distribution, 455–456
- eXtensible Markup Language (XML)
  - annotated with key components, 128
  - attributes, 128
  - content, 128
  - DOM parser, 129
  - element, 128
  - ElementTree parser, 129–130
  - SAX parser, 129
  - tag, 128

■ F

- False positive rate (FPR), 431
- Feature engineering
  - business and domain, 184
  - business problem, 182
  - data and, datasets 178
  - data types, 184
  - definitions, 181
  - evaluating model, 183
  - feature, 182
  - model accuracy, 182
  - models, 179
  - predictive models, 182
  - raw data, 179, 182
  - representation of data, 183
  - unseen data, 182
- Feature extraction methods, 40
- Feature hashing scheme, 208
- Feature scaling
  - jupyter notebook, 239
  - min-max, 240–241
  - online videos, 239

- robust, 241
- standardized, 240
- Feature selection methods, 40
- Figure module
  - axes objects, 162
  - cosine curve, 163–164
  - sine curve, 162–164
- Filter methods, 242
- Fine-tuning pre-trained models, 505
- Fixed-width binning, 193–194
- Forecasting gold price
  - dataset, 474
  - modeling
    - ACF and PACF plots, 480
    - ARIMA(1,1,1), 483
    - arima\_grid\_search\_cv(), 481
    - forecast() method, 483
    - mean and standard deviation plot, 478–479
    - plot, gold prices, 476
    - stationarity, 477
    - statsmodel library, 478
    - test statistic, 479
  - problem statement, 474
  - traditional approaches
    - ARIMA model, 475–476
    - differencing, 475
    - stationarity, 475
    - unit root tests, 475

## G

- Generalized linear models, 38
- Gini impurity/index, 325
- Global parameters, 176
- Global Vectors for Word
  - Representation (GloVe), 351
- Gradient Boosting Machines (GBM) model, 440
- Graph legend, 170–171
- Grayscale image pixels, 227
- Grid search
  - breast cancer dataset, 292, 294
  - SVM, 292
- GridSearchCV() method, 327, 328

## H

- Hacking skills, 17
- Hierarchical clustering model, 260, 269–270
- Histogram of oriented gradients (HOG), 230
- Histograms, price distribution, 155–156
- Hybrid-recommendation engines, 457
- Hyperparameters, 45
  - decision tree, 283
  - definition, 283

- grid search
  - breast cancer dataset, 292, 294
  - SVM, 292
  - randomized search, 294–295
- Hyper Text Markup Language (HTML), 131–132
- Hypothesis models, 261

## I

- Image data
  - binning image intensity distribution, 227
  - canny edge detector, 229
  - channel pixels, 225–227
  - EXIF data, 225
  - grayscale image pixels, 227
  - HOG, 230
  - image aggregation statistics, 228
  - raw image, 224–227
  - SURF, 231
  - two-layer CNN
    - feature map visualizations, 238–239
    - pooling, 236
    - stride, 236
    - visualizing, 237
  - VBOW, 233–235
- Inferential statistics, 25
- Information gain, 325
- Instance based learning methods, 44
- Internet Movie Database (IMDb), 332
- Interpretation model
  - decision trees, 296
  - logistic regression model
    - data point with no cancer, 301–302
    - features, 299
    - malignant cancer, 301
    - worst area feature, 299–300
  - Skater, 296–297
- Inter-Quartile Range (IQR), 241

## J

- Java Script Object Notation (JSON)
  - dict, 126
  - nested attributes, 125
  - object structure, 124
  - pandas, 126–127
  - sample file, 125

## K

- K-fold cross validation, 317, 320, 327–328
- K-means algorithm, 267–268
- K-means clustering model, 215
- Knowledge discovery of databases (KDD), 14, 25

**L**

- Lasso regression, *See* Least absolute shrinkage and selection operator (Lasso) regression
- Latent Dirichlet Allocation (LDA), 216–217, 368
- Latent Semantic Indexing (LSI), 216
- Least absolute shrinkage and selection operator (Lasso) regression, 38
- LeNet CNN model, 33
- Linear algebra, 18
- Linear regression models, 319–320
  - building process, 256
  - candidate model, 256
  - coefficient of determination, 281
  - MSE, 282
  - multiple, 259
  - nonlinear, 259
  - simple, 259
- Line charts, 152–154
- Logistic regression
  - algorithm, 60
  - evaluation/cost function, 262
  - optimization, 263
  - representation, 262
- Log transform, 197
- Long short term memory networks (LSTMs), 34, 355
- Looped networks, 33
- Loss functions, 513–514

**M**

- Machine Learning (ML)
  - benefits, 8
  - bias and variance, 284–286
  - challenges, 64
  - comparison of deep learning and, 29
  - data analysis
    - features, 410–412
    - process and merge datasets, 409
  - datasets, 408
  - definition, 9
  - descriptive statistics, 413
  - evaluation, 261
  - experience (E), 12
  - GitHub repository, 408
  - history, 8
  - inferential statistics, 414–415
  - mini-batches, 44
  - multivariate analysis, 407, 419–426
  - optimization, 261
  - paradigm, 6–7
  - performance (P), 12
  - physicochemical properties, 407
  - predictive modeling, 426–427

- real-world applications, 64
- representation, 261
- student performance data and grant recommendation
  - attributes, 56
  - deployment, 61
  - evaluation, 61
  - feature extraction and engineering, 57–58, 60
  - logistic regression algorithm, 60
  - predictions, 62–64
  - retrieve data, 56–57
- supervised learning, 257
- task (T)
  - anomalous, 11
  - automated machine translation, 11
  - classification/categorization, 11
  - clusters/groups, 11
  - natural language, 11
  - regression, 11
  - structured annotation, 11
  - transcriptions, 11
- UCI Machine Learning Repository, 408
- univariate analysis, 416, 418
- wine quality prediction, 433–446
- wine types, 427–433
- Machine Learning (ML) pipelines
  - components, 180
  - data preparation, 53
  - data processing and wrangling, 53
  - data retrieval, 53
  - deployment and monitoring, 54
  - feature engineering, scaling, and selection, 180
  - feature extraction and engineering, 53
  - feature scaling and selection, 54
  - model evaluation and tuning, 54
  - modeling, 54
  - revisiting, 180
  - supervised, 54
  - unsupervised, 55
- Marginal probability, 23
- Market basket analysis, *See* Association rule-mining method
- Mathematics
  - Bayes Theorem, 24
  - eigen decomposition, 21–22
  - linear algebra, 18
  - matrix, 19–20
  - norm, 21
  - probability, 23
  - random variable, 23
  - scalar, 19
  - SVD, 22
  - tensor, 21
  - vector, 19

Matplotlib  
 annotations, 175  
 axis controls  
   adjust axis, 173  
   log scale, 174  
   tick range, 173–174  
   y-axis, 172  
 figure  
   axes objects, 162  
   cosine curve, 163–164  
   sine curve, 162–164  
 global parameters, 176  
 graph legend, 170–171  
 plot formatting  
   color and alpha properties, 167  
   line\_width and shorthand notation, 170  
   marker and line style properties, 168–169  
 subplots  
   pyplot module, 165  
   subplot2grid() function, 167  
   using add\_subplot method, 165

Matrix  
 numpy array, 19  
 operations, 20  
 row and column index, 19

Matrix factorization based recommendation  
 engines, 461–465

Mean absolute error, 325

Mean squared error (MSE), 282, 324

Million song dataset taste profile, 448

Min-max scaling, 240–241

Model based learning methods, 45

Model evaluation, 271

Model fine-tuning, 330

Modeling, Bike Sharing dataset  
 decision tree based regression  
   algorithms, 325  
   hyperparameters, 325  
   interpretability, 323  
   node splitting, 324–325  
   stopping criteria, 325  
   testing, 329  
   training, 326–328  
 encoded categorical attributes, 319  
 fit\_transform\_ohc() function, 318  
 linear regression  
   testing, 321–323  
   training, 320–321  
 model\_selection module, 318  
 scikit-learn’s train\_test\_split() function, 318

MPQA subjectivity lexicon, 337

Multi-class classification model, 258

Multi-label classification model, 258

Multi-layer perceptrons (MLPs), 32, 352

Multiple regression, 38

Multivariable regression, *See* Multiple regression

## N

Natural language processing (NLP), 14, 331  
 AI, 14  
 applications, 26–27  
 operations on textual data, 27–28

Natural Language Tool Kit (NLTK), 113–115

Neural networks, 14

Nominal categorical variables, 137, 200–202

Non-Negative Matrix factorization, 368

Non-zero vector, 21

Norm, 21

Numeric data, 137  
 binarization, 187–188  
 binning  
   adaptive, 194–197  
   fixed-width, 192–194  
   quantile, 194–197  
 counts, 187  
 interaction features, 189–191  
 Pokémon, 186  
 raw measures, 185  
 rounding operations, 188  
 statistical transformations (*see* Statistical transformations)

## O

Offline learning methods, *See* Batch learning methods

One hot encoding scheme, 203, 205

Online learning methods, 44

Online retail transactions dataset, 374

Optimization methods, 262–263

Ordinal categorical variables, 137, 200, 202–203

Ordinary least squares (OLS), 37

## P

Pandas  
 CSV files, 85–86  
 databases to dataframe, 87  
 dataframe, 84–85  
 data retrieval, 85  
 series, 84

Partition based clustering method, 260, 267

Pattern lexicon, 338

Persistence model, 302

Pie charts, 156–157

Plot formatting  
 color and alpha properties, 167  
 line\_width and shorthand notation, 170  
 marker and line style properties, 168–169

Pokémon  
 attack and defense, 189–190  
 Generation attribute, 202–203  
 generations and legendary status, 203, 205

Pokémon (*cont.*)

- LabelEncoder objects, 205
- numeric data, 186
- raw data, 186
- statistical measures, 186

Pooling layers, 33

Practical computer science, 15

Pre-trained model as feature extractor, 505

Principal component analysis (PCA), 40, 250–252

Probability

- conditional, 23
- defined, 18
- distribution, 23
- marginal, 23
- PDF, 23
- PMF, 23

Probability density function (PDF), 23

Probability mass function (PMF), 23

Python

- ABC, 67
- advanced APIs, 98–99
- advantages, 68
- anaconda python environment, 69–70
- ANNs, 102–104
- ANOVA analysis, 117–118
- community support, 72
- core APIs, 97
- data access
  - head and tail, 87
  - slicing and dicing data, 88–91
- data operations
  - concatenating dataframes, 94–96
  - descriptive statistics functions, 92–93
  - and fillna function, 91–92
  - values attribute, 91
- data science, 71
- deep neural networks, 104
- easy and rapid prototyping, 71
- easy to collaboration, 72
- environment, 69
- installation and execution, 73–74
- Jupyter notebooks, 72–73
- libraries installing, 71
- modules, 116–117
- natural language processing, 112
- neural networks and deep
  - learning, 102
- NLTK, 113–115
- Numpy, 75–77
- one-stop solution, 72
- pitfalls, 68
- powerful set of packages, 71
- regression models, 99–101
- scikit-learn, 96
- statsmodels, 116

- text analytics, 112, 115–116
- Python Package Index (PyPI), 71

## ■ Q

Quasi-Newton methods, 515

## ■ R

- Random forest model, 249
- Randomized parameter search, 294–295
- Random variable, 23
- Raw image, 224–227
- Raw measures, 185
- Receiver Operating Characteristic (ROC) curve
  - AUC, 277
  - FPR, 276
  - sample, 277
  - scoring classifiers, 276
  - steps, 276
  - TPR, 276
- Recommendation engine
  - item similarity based, 459–461
  - libraries, 466
  - matrix factorization, 461–465
  - popularity-based, 458–459
  - singular value decomposition, 463
  - types, 457
  - utility, 457
- Recurrent neural networks (RNNs), 33, 355
- Recursive Feature Elimination (RFE), 247–248
- Regression function, 315
- Regression methods
  - generalized linear models, 38
  - Lasso, 38
  - multiple, 38
  - non-linear, 38
  - OLS, 37
  - polynomial, 38
  - prediction of house prices, 37
  - ridge, 38
  - scikit-learn, 99–101
- Reinforcement learning methods, 42–43
- Retail transactions dataset, 375
- Ridge regression, 38
- Robust scaling, 241

## ■ S

- Scalar, 19
- Semi-supervised learning methods, 42
- Sentiment analysis, movie reviews
  - advanced supervised deep learning models
    - (*see* Advanced supervised deep learning models)

- causation
    - predictive models interpretation, 367
    - topic modeling, 371
  - data getting, 333
  - problem statement, 332
  - setting up dependencies, 332
  - supervised deep learning models
    - averaged word vector representations, 350
    - compile(...) method, 353
    - dependencies, 349
    - DNN model architecture, 353
    - DNN, sentiment classification, 351
    - GloVe embeddings, 351
    - num\_input\_features, 352
    - performance metrics, DNN, 354
    - shuffle parameter, 354
    - softmax activation function, 353
    - text-based sentiment class labels, 349
    - word2vec features, 353
    - word2vec model, 350–351
  - supervised learning, 345–346
  - text normalization pipeline, 333–335
  - traditional supervised machine learning
    - models, 346–348
  - unsupervised lexicon-based models
    - (see Unsupervised lexicon-based models)
  - SentiWordNet lexicon, 340–342
  - Silhouette coefficient (SC), 280
  - Simple API for XML (SAX) parser, 129
  - Singular value decomposition (SVD), 22, 250–251
  - Skater, 297
  - Softmax function, 353
  - Speeded Up Robust Features (SURF), 231
  - SQL, 136
  - Stacking methods, 437
  - Standard gradient descent, 515
  - Statistical methods, 244–247
  - Statistical transformations
    - Box-Cox transform, 198–200
    - log transform, 197
  - Statistics
    - defined, 24
    - descriptive, 24
    - inferential, 25
  - statsmodels, 480
  - Stock price prediction
    - dataset, 484
    - efficient market hypothesis, 483
    - LSTM and RNN
      - regression modeling, 490
      - sequence modeling, 486, 495
      - structure, 485
    - problem statement, 484
    - Prophet tool, 495–496
  - String data
    - stemming and
      - lemmatization, 149
    - stopword removal, 149
    - tokenization, 149
  - Subplots
    - add\_subplot method, 165
    - pyplot module, 165
    - subplot2grid() function, 167
  - Supervised learning methods
    - classification, 36, 345–346
    - objective, 35
    - regression
      - generalized linear models, 38
      - Lasso, 38
      - multiple, 38
      - non-linear, 38
      - OLS, 37
      - polynomial, 38
      - prediction of house prices, 37
      - ridge, 38
    - training data, 35
  - Support vector machine (SVM) model, 292
- **T**
- Temporal data
    - date-based features, 221
    - time-based features, 222–224
  - Tensor, 21
  - Text analytics, 14
  - Text data, 137, 209–210
  - Text normalization
    - expand\_contractions(...) function, 333
    - lemmatize\_text(...), 334
    - module, 335–336
    - normalize\_corpus(...), 334
    - remove\_accented\_chars(...)
      - function, 333
    - remove\_special\_characters(...), 333
    - remove\_stopwords(...), 334
    - strip\_html\_tags(...) function, 333
  - Text pre-processing, 210–211
  - TF-IDF model, 213
  - Theoretical computer science, 15
  - Threshold-based methods, 243–244
  - Time-based features, 222–224
  - Time series data analysis
    - components, 469–470
    - date\_of\_visit, 468
    - pandas, 468
    - smoothing techniques
      - exponential smoothening, 473
      - moving average, 471–472



## ■ INDEX

Time series forecasting, 468  
Traditional programming paradigm, 5  
Traditional supervised machine learning models, 346–348  
True positive rate (TPR), 431  
Tuning model, 282

## ■ U

Unsupervised learning methods, 41  
  anomaly detection, 41  
  clustering, 39  
  defined, 38  
  dimensionality reduction, 40  
Unsupervised lexicon-based models  
  AFINN lexicon, 338  
  Bing Liu’s lexicon, 337  
  dependencies and configuration settings, 336  
  MPQA subjectivity lexicon, 337  
  pattern lexicon, 338  
  SentiWordNet Lexicon, 340–342  
  VADER lexicon, 342–344  
User-based recommendation engines, 457

## ■ V

VADER lexicon, 342–344  
Variance reduction, 325  
Vector, 19  
Video game genres, 201–202  
Visual bag of words model (VBOW)  
  K-means model, 233–234  
  SURF feature, 234–235  
V-measure, 279

## ■ W

Web crawler, 132  
Web scraping  
  Apress web site’s blog page, 132, 134  
  BeautifulSoup library, 135–136  
  crawl, 132  
  regular expression, 134–135  
  scrape, 132  
Wine quality prediction  
  alcohol and volatile acidity, 446  
  Bagging methods, 437  
  Boosting methods, 437  
  DecisionTreeClassifier estimator, 434  
  gini parameter, 436  
  hyperparameters, 438–439  
  LimeTabularExplainer object, 443  
  micro-averaging, 441–442  
  model interpretation, 444  
  random forest model, 437–438  
  scikit-learn framework, 445  
  skater, 440–441  
  stacking methods, 437  
  train and test datasets, 433  
  tree model, 435  
  XGBoost model, 440  
word2vec embedding model, 217–220  
Wrapper methods, 242

## ■ X, Y

XML, *See* eXtensible Markup Language (XML)

## ■ Z

Z-score scaling, 240